

**Volume A:
Definition of the CIDOC Conceptual
Reference Model**

Produced by the CIDOC CRM
Special Interest Group

Version 7.2.1

~~September~~ ~~February~~ 20224

Editors: Chryssoula Bekiari, George Bruseker, Martin Doerr,
Christian-Emil Ore, Stephen Stead, Athanasios Velios

CC BY 4.0  ~~2021-2022~~ Individual Contributors to CIDOC CRM 7.2.1

Definition of the CIDOC Conceptual Reference Model version 7.2.1

This page is left blank on purpose

Table of Contents

Introduction	9
Objectives of the CIDOC CRM	9
Scope of the CIDOC CRM	10
Compatibility with the CIDOC CRM	12
Terminology	13
Applied Form	21
Naming Conventions	21
Inheritance and Transitivity	22
Shortcuts	22
About the logical expressions used in the CIDOC CRM	22
Property Quantifiers	24
Modelling principles	27
Reality, Knowledge Bases and CIDOC CRM	27
Authorship of Knowledge Base Contents	28
Extensions of CIDOC CRM	29
Minimality	31
Monotonicity	31
Disjointness	33
Introduction to the basic concepts	35
Relations with Events	36
Spatial Relations	39
Temporal Relations	41
Spatiotemporal Relations	42
Specific Modelling Constructs	44
About Types	44
Temporal Relation Primitives based on fuzzy boundaries	45
Class & Property Hierarchies	50
CIDOC CRM Class Hierarchy	51
CIDOC CRM Property Hierarchy	54
CIDOC CRM Class Declarations	59
E1 CRM Entity	60
E2 Temporal Entity	60
E3 Condition State	61
E4 Period	62
E5 Event	64
E6 Destruction	65
E7 Activity	66
E8 Acquisition	67
E9 Move	68
E10 Transfer of Custody	68
E11 Modification	69
E12 Production	70
E13 Attribute Assignment	71
E14 Condition Assessment	73
E15 Identifier Assignment	73
E16 Measurement	74
E17 Type Assignment	75
E18 Physical Thing	75
E19 Physical Object	76
E20 Biological Object	77
E21 Person	77
E22 Human-Made Object	78
E24 Physical Human-Made Thing	78
E25 Human-Made Feature	79

E26 Physical Feature	80
E27 Site	81
E28 Conceptual Object.....	81
E29 Design or Procedure.....	82
E30 Right.....	83
E31 Document.....	83
E32 Authority Document.....	84
E33 Linguistic Object.....	84
E34 Inscription	85
E35 Title	85
E36 Visual Item	86
E37 Mark.....	87
E39 Actor.....	87
E41 Appellation.....	88
E42 Identifier.....	89
E52 Time-Span.....	90
E53 Place.....	91
E54 Dimension.....	92
E55 Type.....	93
E56 Language.....	93
E57 Material	94
E58 Measurement Unit.....	94
E59 Primitive Value.....	95
E60 Number	96
E61 Time Primitive	96
E62 String.....	97
E63 Beginning of Existence	97
E64 End of Existence	98
E65 Creation.....	99
E66 Formation	99
E67 Birth	100
E68 Dissolution	100
E69 Death.....	100
E70 Thing	101
E71 Human-Made Thing	101
E72 Legal Object.....	102
E73 Information Object.....	102
E74 Group	103
E77 Persistent Item.....	104
E78 Curated Holding	105
E79 Part Addition	106
E80 Part Removal.....	107
E81 Transformation.....	107
E83 Type Creation	108
E85 Joining.....	109
E86 Leaving	109
E87 Curation Activity.....	110
E89 Propositional Object.....	110
E90 Symbolic Object.....	111
E92 Spacetime Volume.....	112
E93 Presence	113
E94 Space Primitive	113
E95 Spacetime Primitive	114
E96 Purchase.....	115
E97 Monetary Amount	116
E98 Currency.....	116
E99 Product Type	117
CIDOC CRM Property Declarations.....	119
P1 is identified by (identifies)	120
P2 has type (is type of).....	121

P3 has note	121
P4 has time-span (is time-span of)	122
P5 consists of (forms part of)	123
P7 took place at (witnessed)	123
P8 took place on or within (witnessed)	124
P9 consists of (forms part of)	125
P10 falls within (contains).....	125
P11 had participant (participated in).....	126
P12 occurred in the presence of (was present at).....	127
P13 destroyed (was destroyed by)	127
P14 carried out by (performed)	128
P15 was influenced by (influenced)	129
P16 used specific object (was used for).....	129
P17 was motivated by (motivated)	130
P19 was intended use of (was made for):	131
P20 had specific purpose (was purpose of)	131
P21 had general purpose (was purpose of).....	132
P22 transferred title to (acquired title through)	133
P23 transferred title from (surrendered title through).....	133
P24 transferred title of (changed ownership through)	134
P25 moved (moved by)	134
P26 moved to (was destination of)	135
P27 moved from (was origin of)	135
P28 custody surrendered by (surrendered custody through).....	136
P29 custody received by (received custody through)	136
P30 transferred custody of (custody transferred through)	137
P31 has modified (was modified by).....	138
P32 used general technique (was technique of).....	138
P33 used specific technique (was used by).....	139
P34 concerned (was assessed by).....	139
P35 has identified (was identified by)	140
P37 assigned (was assigned by).....	141
P38 deassigned (was deassigned by)	141
P39 measured (was measured by)	142
P40 observed dimension (was observed in).....	142
P41 classified (was classified by).....	143
P42 assigned (was assigned by).....	144
P43 has dimension (is dimension of).....	144
P44 has condition (is condition of).....	145
P45 consists of (is incorporated in)	145
P46 is composed of (forms part of)	146
P48 has preferred identifier (is preferred identifier of).....	148
P49 has former or current keeper (is former or current keeper of).....	148
P50 has current keeper (is current keeper of)	149
P51 has former or current owner (is former or current owner of)	150
P52 has current owner (is current owner of)	150
P53 has former or current location (is former or current location of).....	151
P54 has current permanent location (is current permanent location of)	152
P55 has current location (currently holds).....	152
P56 bears feature (is found on).....	153
P57 has number of parts	154
P59 has section (is located on or within)	154
P62 depicts (is depicted by).....	155
P65 shows visual item (is shown by).....	156
P67 refers to (is referred to by).....	156
P68 foresees use of (use foreseen by).....	157
P69 has association with (is associated with)	158
P70 documents (is documented in).....	158
P71 lists (is listed in)	159
P72 has language (is language of).....	159

P73 has translation (is translation of)	160
P74 has current or former residence (is current or former residence of)	161
P75 possesses (is possessed by).....	161
P76 has contact point (provides access to)	162
P79 beginning is qualified by	162
P80 end is qualified by	163
P81 ongoing throughout	163
P82 at some time within	164
P86 falls within (contains).....	165
P89 falls within (contains).....	165
P90 has value.....	166
P91 has unit (is unit of)	166
P92 brought into existence (was brought into existence by)	166
P93 took out of existence (was taken out of existence by)	167
P94 has created (was created by).....	168
P95 has formed (was formed by).....	169
P96 by mother (gave birth).....	169
P97 from father (was father for)	170
P98 brought into life (was born).....	170
P99 dissolved (was dissolved by).....	171
P100 was death of (died in)	171
P101 had as general use (was use of)	172
P102 has title (is title of)	173
P103 was intended for (was intention of)	173
P104 is subject to (applies to).....	174
P105 right held by (has right on)	174
P106 is composed of (forms part of)	175
P107 has current or former member (is current or former member of)	175
P108 has produced (was produced by)	176
P109 has current or former curator (is current or former curator of).....	177
P110 augmented (was augmented by)	177
P111 added (was added by)	178
P112 diminished (was diminished by).....	178
P113 removed (was removed by)	179
P121 overlaps with	179
P122 borders with.....	180
P123 resulted in (resulted from)	181
P124 transformed (was transformed by)	181
P125 used object of type (was type of object used in).....	182
P126 employed (was employed in)	183
P127 has broader term (has narrower term)	183
P128 carries (is carried by).....	184
P129 is about (is subject of)	184
P130 shows features of (features are also found on)	185
P132 spatiotemporally overlaps with	187
P133 is spatiotemporally separated from.....	187
P134 continued (was continued by).....	188
P135 created type (was created by)	189
P136 was based on (supported type creation).....	189
P137 exemplifies (is exemplified by).....	190
P138 represents (has representation)	191
P139 has alternative form (is alternative form of).....	191
P141 assigned (was assigned by).....	193
P142 used constituent (was used in)	194
P143 joined (was joined by)	195
P144 joined with (gained member by)	195
P145 separated (left by).....	196
P146 separated from (lost member by).....	197
P147 curated (was curated by)	197
P148 has component (is component of)	198

P150 defines typical parts of (defines typical wholes for).....	199
P151 was formed from (participated in).....	200
P152 has parent (is parent of).....	200
P156 occupies (is occupied by).....	201
P157 is at rest relative to (provides reference space for).....	202
P160 has temporal projection (is temporal projection of).....	203
P161 has spatial projection (is spatial projection of).....	203
P164 is temporally specified by (temporally specifies).....	204
P165 incorporates (is incorporated in).....	205
P166 was a presence of (had presence).....	206
P167 was within (includes).....	206
P168 place is defined by (defines place).....	207
P169 defines spacetime volume (spacetime volume is defined by).....	208
P170 defines time (time is defined by).....	208
P171 at some place within.....	209
P172 contains.....	209
P173 starts before or with the end of (ends after or with the start of).....	210
P174 starts before the end of (ends after the start of).....	211
P175 starts before or with the start of (starts after or with the start of).....	212
P176 starts before the start of (starts after the start of).....	213
P177 assigned property of type (is type of property assigned).....	214
P179 had sales price (was sales price of).....	215
P180 has currency (was currency of).....	216
P182 ends before or with the start of (starts after or with the end of).....	216
P183 ends before the start of (starts after the end of).....	217
P184 ends before or with the end of (ends with or after the end of).....	218
P185 ends before the end of (ends after the end of).....	219
P186 produced thing of product type (is produced by).....	220
P187 has production plan (is production plan for).....	221
P188 requires production tool (is production tool for).....	221
P189 approximates (is approximated by).....	222
P190 has symbolic content.....	223
P191 had duration (was duration of).....	223
P195 was a presence of (had presence).....	224
P196 defines (is defined by).....	224
P197 covered parts of (was partially covered by).....	225
P198 holds or supports (is held or supported by).....	226
Works Cited.....	229
Appendix.....	240
Deprecated classes and properties.....	240
Deprecated Class Migration Instructions.....	240
Deprecated Property Migration Instructions.....	241
Amendments.....	243

Table of Tables

Table 1: Symbolic Operators in First Order Logic Representation	23
Table 2: Temporal Relation Primitives	48
Table 3: CIDOC CRM Class Hierarchy	51
Table 4: CIDOC CRM Property Hierarchy	54
Table 5: Deprecated Class Migration Instructions	240
Table 6: Deprecated Property Migration Instructions	241

Table of Figures

Figure 1: High Level Properties and Classes of CIDOC CRM	37
Figure 2: CIDOC CRM Encoding Example (Winkelmann seeing Laocoön).....	38
Figure 3: Symbolic Representation of "Winkelmann seeing Laocoön" as an Evolution in Space and Time	39
Figure 4: Basic CIDOC CRM Properties and Classes for Reasoning about Spatial Information	40
Figure 5: Basic CIDOC CRM Properties and Classes for Reasoning about Temporal Information	42
Figure 6: Basic CIDOC CRM Properties and Classes for Reasoning with Spacetime Volumes.....	43
Figure 7: Explanation of Interior and Boundary and an Example of Use from P174 starts before the end of (ends after the start of).....	47
Figure 8: Temporal entity A starts before or with the end of temporal entity B. Here A is longer than B.....	210
Figure 9: Temporal entity A starts before or with the end of temporal entity B. Here A is shorter than B.....	210
Figure 10: Temporal entity A starts before the end of temporal entity B. Here A is longer than B	212
Figure 11: Temporal entity A starts before the end of temporal entity B. Here A is shorter than B	212
Figure 12: Temporal entity A starts before or with the start of temporal entity B. Here A is longer than B.....	213
Figure 13: Temporal entity A starts before or with the start of temporal entity B. Here A is shorter than B.....	213
Figure 14: Temporal entity A starts before the start of temporal entity B. Here A is longer than B	214
Figure 15: Temporal entity A starts before the start of temporal entity B. Here A is shorter than B	214
Figure 16: Temporal entity A ends before or with the start of temporal entity B. Here A is longer than B.....	217
Figure 17: Temporal entity A ends before or with the start of temporal entity B. Here A is shorter than B.....	217
Figure 18: Temporal entity A ends before the start of temporal entity B. Here A is longer than B	218
Figure 19: Temporal entity A ends before the start of temporal entity B. Here A is shorter than B	218
Figure 20: Temporal entity A ends before or with the end of temporal entity B. Here A is longer than B	219
Figure 21: Temporal entity A ends before or with the end of temporal entity B. Here A is shorter than B	219
Figure 22: Temporal entity A ends before the end of temporal entity B. Here A is longer than B	220
Figure 23: Temporal entity A ends before the end of temporal entity B. Here A is shorter than B	220

Introduction

This document is the formal definition of the CIDOC Conceptual Reference Model (“CIDOC CRM”), a formal ontology intended to facilitate the integration, mediation and interchange of heterogeneous cultural heritage information and similar information from other domains, as further detailed below. The CRM is the culmination of more than two decades of standards development work by the International Committee for Documentation (CIDOC) of the International Council of Museums (ICOM). Work on the CRM itself began in 1996 under the auspices of the ICOM-CIDOC Documentation Standards Working Group. Since 2000, development of the CRM has been officially delegated by ICOM-CIDOC to the CIDOC CRM Special Interest Group (SIG). The SIG, in turn, collaborates with the ISO working group ISO/TC46/SC4/WG9 to bring the CRM to the form and status of an International Standard. This set of collaborations has resulted in the production of ISO21127:2004 and ISO21127:2014, the ISO standard editions of the CIDOC CRM. This collaboration will be continued in order to support the next update of the ISO standard edition. The present document belongs to the series of evolving versions of the formal definition of the CRM, which serve the ISO working group as community draft for the standard. Eventual minor differences, in semantics and notation, of the ISO standard text from the present, community CIDOC CRM version, which the ISO working group requires and implements, will be harmonized in the subsequent versions of the present, community CIDOC CRM formal definition document.

Objectives of the CIDOC CRM

The primary role of the CIDOC CRM is to enable the exchange and integration of information from heterogeneous sources for the reconstruction and interpretation of the past at a human scale, based on all kinds of material evidence, including texts, audio-visual material and oral tradition. It starts from, but is not limited to, the needs of museum documentation and research based on museum holdings. It aims at providing the semantic definitions and clarifications needed to transform disparate, localised information sources into a coherent global resource, be it within a larger institution, in intranets or on the Internet, and to make it available for scholarly interpretation and scientific evaluation. These goals determine the constructs and level of detail of the CIDOC CRM.

More specifically, it defines, in terms of a formal ontology, the **underlying semantics** of database **schemata** and **structured** documents used in the documentation of cultural heritage and scientific activities. In particular it defines the semantics related to the study of the past and current state of our world, as it is characteristic for museums, but also or other cultural heritage institutions and disciplines. It does **not** define any of the **terminology** appearing typically as data in the respective data structures; it foresees, however, the characteristic relationships for its use. It does **not** aim at proposing what cultural heritage institutions should document. Rather, it explains the logic of what they actually currently document, and thereby enables **semantic interoperability**.

The CIDOC CRM intends, moreover, to provide a model of the intellectual structure of the respective kinds of mentioned documentation in logical terms. As such, it has not been optimised for implementation specific storage and processing factors. Actual system implementations may lead to solutions where elements and links between relevant elements of our conceptualizations are no longer explicit in a database or other structured storage system. For instance, the birth event that connects elements such as father, mother, birth date, birth place may not appear in the database, in order to save storage space or response time of the system. The CIDOC CRM provides a conceptual and technical means to explain how such apparently disparate entities are semantically and logically interconnected, and how the ability of the database to answer certain intellectual questions is affected by the omission of such elements and links.

The CIDOC CRM aims to support the following specific functionalities:

Inform developers of information systems as a guide to good practice in conceptual modelling, in order to effectively structure and relate information assets of cultural documentation.

- Serve as a common language for domain experts and IT developers to formulate requirements and to agree on system functionalities with respect to the correct handling of cultural contents.
- To serve as a formal language for the identification of common information contents in different data formats; in particular, to support the implementation of automatic data transformation algorithms from local to global data structures without loss of meaning. The latter being useful for data exchange, data migration from legacy systems, data information integration and mediation of heterogeneous sources.
- To support associative queries against integrated resources by providing a global model of the basic classes and their associations to formulate such queries.
- It is further believed that advanced natural language algorithms and case-specific heuristics can take significant advantage of the CIDOC CRM to resolve free text information into a formal logical form, if that is regarded beneficial. The CIDOC CRM is not thought, however, to be a means to replace scholarly text, rich in meaning, by logical forms, but only a means to identify related data.

Users of the CIDOC CRM should be aware that the definition of data entry systems requires support of community-specific terminology, guidance to what should be documented and in which sequence, and application-specific consistency controls. The CIDOC CRM does not provide such notions.

By its very structure and formalism, the CIDOC CRM is extensible and users are encouraged to create extensions for the needs of more specialized communities and applications.

Scope of the CIDOC CRM

The overall scope of the CIDOC CRM can be summarised in simple terms as the curated, **factual knowledge** about the past at a human scale.

However, a more detailed and useful definition can be articulated by defining both the **Intended Scope**, a broad and maximally-inclusive definition of general application principles, and the **Practical Scope**, which is expressed by the overall scope of a growing reference set of specific, identifiable documentation standards and practices that the CIDOC CRM aims to semantically describe, restricted, always, in its details to the limitations of the Intended Scope.

The reasons for these distinctions between Intended and Practical Scope are twofold. Firstly, the CIDOC CRM is developed in a “bottom-up” manner, starting from well-understood, actual, and widely used concepts of domain experts, which are disambiguated and gradually generalized as more forms of encoding are encountered. This aims to avoid the misadaptations and vagueness that can sometimes be found in introspection-driven attempts to find overarching concepts for such a wide scope, and provides stability to the generalizations found. Secondly, it is a means to identify and keep a focus on the concepts most needed by the communities working in the scope of the CIDOC CRM and to maintain a well-defined agenda for its evolution.

The Intended Scope of the CIDOC CRM may, therefore, be defined as all information required for the exchange and integration of heterogeneous scientific and scholarly documentation about the past at a human scale and the available documented and empirical evidence for this. This definition requires further elaboration:

- The term “scientific and scholarly documentation” is intended to convey the requirement that the depth and quality of descriptive information that can be handled by the CIDOC CRM should be sufficient for serious academic research. This does not mean that information intended for presentation to members of the general public is excluded, but rather that the CRM is intended to provide the level of detail and precision expected and required by museum professionals and researchers in the field.
- As “available documented and material evidence” are regarded all types of material collected and displayed by museums and related institutions, as defined by ICOM¹, and other- collections, in-situ objects, sites,

¹ The ICOM Statutes provide a definition of the term “museum” at <http://icom.museum/statutes.html#2>

monuments and intangible heritage relating to fields such as social history, ethnography, archaeology, fine and applied arts, natural history, history of sciences and technology.

- The concept “documentation” includes the detailed description of individual items, in situ or within collections, groups of items and collections as a whole, as well as practices of intangible heritage. It pertains to their current state as well as to information about their past. The CIDOC CRM is specifically intended to cover contextual information: the historical, geographical and theoretical background that gives cultural heritage collections much of their cultural significance and value.
- ~~The documentation of collections includes the detailed description of individual items within collections, groups of items and collections as a whole. The CIDOC CRM is specifically intended to cover contextual information: the historical, geographical and theoretical background that gives museum collections much of their cultural significance and value.~~
- The exchange of relevant information with libraries and archives, and the harmonisation of the CIDOC CRM with their models, falls within the Intended Scope of the CIDOC CRM.
- Information required solely for the administration and management of cultural institutions, such as information relating to personnel, accounting, and visitor statistics, falls outside the Intended Scope of the CIDOC CRM.

The Practical Scope² of the CIDOC CRM is expressed in terms of the set of reference standards and de facto standards for documenting factual knowledge that have been used to guide and validate the CIDOC CRM’s development and its further evolution. The CRM covers the same domain of discourse as the union of these reference standards; this means that for data correctly encoded according to these documentation formats there can be a CIDOC CRM-compatible expression that conveys the same meaning.

As part of the on-going work of keep the standard up-to-date, discussions on the types of bias present in the CIDOC CRM are in progress within the CIDOC CRM community.

Compatibility with the CIDOC CRM

Users intending to take advantage of the semantic interoperability offered by the CIDOC CRM should ensure conformance with the relevant data structures. Conformance pertains either to data to be made accessible in an integrated environment or intended for transport to other environments. Any encoding of data in a formal language that preserves the relations of the classes, properties, and inheritance rules defined by this International Standard, is regarded as conformant.

Conformance with the CIDOC CRM does not require complete matching of all local documentation structures, nor that all concepts and structures present in this International Standard be implemented. This International Standard is intended to allow room both for extensions, needed to capture the full richness of cultural documentation, and for simplification, in the interests of economy. A system will be deemed partially conformant if it supports a subset of subclasses and sub properties defined by this International Standard. Designers of the system should publish details of the constructs that are supported.

The focus of the CIDOC CRM is the exchange and mediation of structured information. It does not require the interpretation of unstructured (free text) information into a structured, logical form. Unstructured information is supported, but falls outside the scope of conformance considerations.

Any documentation system will be deemed conformant with this International Standard, regardless of the internal data structures it uses; if a deterministic logical algorithm can be constructed, that transforms data contained in the system into a directly compatible form without loss of meaning.

No assumptions are made as to the nature of this algorithm. "Without loss of meaning" signifies that designers and users of the system are satisfied that the data representation corresponds to the semantic definitions provided by this International Standard.

² The Practical Scope of the CIDOC CRM, including a list of the relevant museum documentation standards, is discussed in more detail on the CIDOC CRM website at <http://cidoc.ics.forth.gr/scope.html>

Terminology

The following definitions of key terminology used in this document are provided both as an aid to readers unfamiliar with object-oriented modelling terminology, and to specify the precise usage of terms that are sometimes applied inconsistently across the object-oriented modelling community for the purpose of this document. Where applicable, the editors have tried to consistently use terminology that is compatible with that of the Resource Description Framework (RDF),³ a recommendation of the World Wide Web Consortium. The editors have tried to find a language, which is comprehensible to the non-computer expert and precise enough for the computer expert so that both understand the intended meaning.

class A class is a category of items that share one or more common traits serving as criteria to identify the items belonging to the class. These **properties** need not be explicitly formulated in logical terms, but may be described in a text (here called a **scope note**) that refers to a common conceptualisation of domain experts. The sum of these traits is called the **intension** of the class. A class may be the **domain** or **range** of none, one or more properties formally defined in a model. The formally defined properties need not be part of the intension of their domains or ranges: such properties are optional. An item that belongs to a class is called an **instance** of this class. A class is associated with an open set of real-life instances, known as the **extension** of the class. Here “open” is used in the sense that it is generally beyond our capabilities to know all instances of a class in the world and indeed that the future may bring new instances about at any time (**Open World**). Therefore, a class cannot be defined by enumerating its instances. A class plays a role analogous to a grammatical noun, and can be completely defined without reference to any other construct (unlike properties, which must have an unambiguously defined domain and range). In some contexts, the terms individual class, entity or node are used synonymously with class.

For example:

Person is a class. To be a Person may actually be determined by DNA characteristics, but we all know what a Person is. A Person may have the property of being a member of a Group, but it is not necessary to be member of a Group in order to be a Person. We shall never know all Persons of the past. There will be more Persons in the future.

subclass A subclass is a **class** that is a specialization of another class (its **superclass**). Specialization or the IsA relationship means that:

- 1 all **instances** of the subclass are also instances of its superclass,
- 2 the **intension** of the subclass extends the intension of its superclass, i.e., its traits are more restrictive than that of its superclass and
- 3 the subclass inherits the definition of all of the **properties** declared for its superclass without exceptions (**strict inheritance**), in addition to having none, one or more properties of its own.

A subclass can have more than one immediate superclass and consequently inherits the properties of all of its superclasses (**multiple inheritance**). The IsA relationship or specialization between two or more classes gives rise to a structure known as a class hierarchy. The IsA relationship is transitive and may not be cyclic. In some contexts (e.g., the programming language C++) the term derived class is used synonymously with subclass.

³ Information about the Resource Description Framework (RDF) can be found at <http://www.w3.org/RDF/>

For example:

Every Person IsA Biological Object, or Person is a subclass of Biological Object.

Also, every Person IsA Actor. A Person may die. However, other kinds of Actors, such as companies, don't die (c.f. 2).

Every Biological Object IsA Physical Object. A Physical Object can be moved. Hence, a Person can be moved also (c.f. 3).

superclass

A superclass is a **class** that is a generalization of one or more other classes (its **subclasses**), which means that it subsumes all **instances** of its subclasses, and that it can also have additional instances that do not belong to any of its subclasses. The **intension** of the superclass is less restrictive than any of its subclasses. This subsumption relationship or generalization is the inverse of the IsA relationship or specialization.

For example:

“Biological Object subsumes Person” is synonymous with “Biological Object is a superclass of Person”. It needs fewer traits to identify an item as a Biological Object than to identify it as a Person.

intension

The intension of a **class** or **property** is its intended meaning. It consists of one or more common traits shared by all **instances** of the class or property. These traits need not be explicitly formulated in logical terms, but may just be described in a text (here called a **scope note**) that refers to a conceptualisation common to domain experts. In particular, the so-called **primitive** concepts, which make up most of the CIDOC CRM, cannot be further reduced to other concepts by logical terms.

extension

The extension of a **class** is the set of all real-life **instances** belonging to the class that fulfil the criteria of its **intension**. This set is “open” in the sense that it is generally beyond our capabilities to know all instances of a class in the world and indeed that the future may bring new instances about at any time (**Open World**). An information system may at any point in time refer to some instances of a class, which form a subset of its extension.

scope note

A scope note is a textual description of the **intension** of a **class** or **property**.

Scope notes are not formal modelling constructs, but are provided to help explain the intended meaning and application of the CIDOC CRM's classes and properties. Basically, they refer to a conceptualisation common to domain experts and disambiguate between different possible interpretations. Illustrative example **instances** of classes and properties are also regularly provided in the scope notes for explanatory purposes.

instance

An instance of a **class** is a real-world item that fulfils the criteria of the **intension** of the class. Note, that the number of **instances** declared for a class in an information system is typically less than the total in the real world. For example, you are an instance of Person, but you are not mentioned in all information systems describing Persons.

For example:

The painting known as the “The Mona Lisa” is an instance of the class [E22_Human-Made Object](#).

An instance of a **property** is a factual relation between an instance of the **domain** and an instance of the **range** of the property that matches the criteria of the **intension** of the property.

For example:

The Mona Lisa *has former or current owner*. The Louvre is an instance of the property *P51 has former or current owner (is former or current owner of)*.

property

A property serves to define a relationship of a specific kind between two **classes**. The property is characterized by an **intension**, which is conveyed by a **scope note**. A property plays a role analogous to a grammatical verb, in that it must be defined with reference to both its **domain** and **range**, which are analogous to the subject and object in grammar (unlike classes, which can be defined independently). It is arbitrary, which class is selected as the domain, just as the choice between active and passive voice in grammar is arbitrary. In other words, a property can be interpreted in both directions, with two distinct, but related interpretations. Properties may themselves have properties that relate to other classes (This feature is used in this model only in order to describe dynamic subtyping of properties). Properties can also be specialized in the same manner as classes, resulting in ISA relationships between **subproperties** and their **superproperties**.

In some contexts, the terms attribute, reference, link, role or slot are used synonymously with property.

For example:

“Physical Human-Made Thing *depicts* CRM Entity” is equivalent to “CRM Entity *is depicted by* Physical Human-Made Thing”.

inverse of

The inverse of a property is the reinterpretation of a **property** from **range** to **domain** without more general or more specific meaning, similar to the choice between active and passive voice in some languages. In contrast to some knowledge representation languages, such as RDF and OWL, we regard that the inverse of a property is not a property in its own right that needs an explicit declaration of being inverse of another, but an interpretation implicitly existing for any property. The inverse of the inverse of a property is identical to the property itself, i.e., its primary sense of direction.

For example:

“CRM Entity *is depicted by* Physical Human-Made Thing” is the inverse of “Physical Human-Made Thing *depicts* CRM Entity”

subproperty

A subproperty is a **property** that is a specialization of another property (its **superproperty**). Specialization or ISA relationship means that:

- 1 all **instances** of the subproperty are also instances of its superproperty,
- 2 the **intension** of the subproperty extends the intension of the superproperty, i.e., its traits are more restrictive than that of its superproperty,
- 3 the **domain** of the subproperty is the same as the domain of its superproperty or a **subclass** of that domain,
- 4 the **range** of the subproperty is the same as the range of its superproperty or a subclass of that range,
- 5 the subproperty inherits the definition of all of the properties declared for its superproperty without exceptions (**strict inheritance**), in addition to having none, one or more properties of its own.

A subproperty can have more than one immediate superproperty and consequently inherits the properties of all of its superproperties (**multiple inheritance**). The ISA relationship or specialization between two or more properties gives rise to the structure we call a property

hierarchy. The ISA relationship is transitive and may not be cyclic.

Some object-oriented programming languages, such as C++, do not contain constructs that allow for the expression of the specialization of properties as sub-properties.

Alternatively, a property may be subproperty of the **inverse of** another property, i.e., reading the property from range to domain. In that case:

- 1 all instances of the subproperty are also instances of the inverse of the other property,
- 2 the intension of the subproperty extends the intension of the inverse of the other property, i.e., its traits are more restrictive than that of the inverse of the other property,
- 3 the domain of the subproperty is the same as the range of the other property or a subclass of that range,
- 4 the range of the subproperty is the same as the domain of the other property or a subclass of that domain,
- 5 the subproperty inherits the definition of all of the properties declared for the other property without exceptions (strict inheritance), in addition to having none, one or more properties of its own. The definitions of inherited properties have to be interpreted in the inverse sense of direction of the subproperty, i.e., from range to domain.

superproperty	A superproperty is a property that is a generalization of one or more other properties (its subproperties), which means that it subsumes all instances of its subproperties, and that it can also have additional instances that do not belong to any of its subproperties. The intension of the superproperty is less restrictive than any of its subproperties. The subsumption relationship or generalization is the inverse of the ISA relationship or specialization. A superproperty may be a generalization of the inverse of another property.
domain	The domain is the class for which a property is formally defined. This means that instances of the property are applicable to instances of its domain class. A property must have exactly one domain, although the domain class may always contain instances for which the property is not instantiated. The domain class is analogous to the grammatical subject of the phrase for which the property is analogous to the verb. It is arbitrary which class is selected as the domain and which as the range , just as the choice between active and passive voice in grammar is arbitrary. Property names in the CIDOC CRM are designed to be semantically meaningful and grammatically correct when read from domain to range. In addition, the inverse property name, normally given in parentheses, is also designed to be semantically meaningful and grammatically correct when read from range to domain.
range	The range is the class that comprises all potential values of a property . That means that instances of the property can link only to instances of its range class. A property must have exactly one range, although the range class may always contain instances that are not the value of the property. The range class is analogous to the grammatical object of a phrase for which the property is analogous to the verb. It is arbitrary which class is selected as domain and which as range, just as the choice between active and passive voice in grammar is arbitrary. Property names in the CIDOC CRM are designed to be semantically meaningful and grammatically correct when read from domain to range. In addition, the inverse property name, normally given in parentheses, is also designed to be semantically meaningful and grammatically correct when read from range to domain.

inheritance	<p>Inheritance of properties from superclasses to subclasses means that if an item x is an instance of a class A, then:</p> <ol style="list-style-type: none"> 1 all properties that must hold for the instances of any of the superclasses of A must also hold for item x, and 2 all optional properties that may hold for the instances of any of the superclasses of A may also hold for item x.
strict inheritance	<p>Strict inheritance means that there are no exceptions to the inheritance of properties from superclasses to subclasses. For instance, some systems may declare that elephants are grey, and regard a white elephant as an exception. Under strict inheritance it would hold that: if all elephants were grey, then a white elephant could not be an elephant. Obviously not all elephants are grey. To be grey is not part of the intension of the concept elephant but an optional property. The CIDOC CRM applies strict inheritance as a normalization principle.</p>
multiple inheritance	<p>Multiple inheritance means that a class A may have more than one immediate superclass. The extension of a class with multiple immediate superclasses is a subset of the intersection of all extensions of its superclasses. The intension of a class with multiple immediate superclasses extends the intensions of all its superclasses, i.e., its traits are more restrictive than any of its superclasses. If multiple inheritance is used, the resulting “class hierarchy” is a directed graph and not a tree structure. If it is represented as an indented list, there are necessarily repetitions of the same class at different positions in the list.</p> <p>For example:</p> <p>Person is both_ an Actor and a Biological Object.</p>
multiple Instantiation	<p>Multiple Instantiation is the term that describes the case that an instance of class A is also regarded as an instance of one or more other classes B1...n at the same time. When multiple instantiation is used, it has the effect that the properties of all these classes become available to describe this instance. For instance, some particular cases of destruction may also be activities (e.g., Herostratos’ deed), but not all destructions are activities (e.g., destruction of Herculaneum). In comparison, multiple inheritance describes the case that all instances of a class A are implicitly instances of all superclasses of A, by virtue of the definition of the class A, whereas the combination of classes used for multiple instantiation is a characteristic of particular instances only. It is important to note that multiple instantiation is not allowed using combinations of disjoint classes.</p>
endurant, perdurant	<p>“The difference between enduring and perduring entities (which we shall also call <i>endurants</i> and <i>perdurants</i>) is related to their behaviour in time. Endurants are wholly present (i.e., all their proper parts are present) at any time they are present. Perdurants, on the other hand, just extend in time by accumulating different temporal parts, so that, at any time they are present, they are only partially present, in the sense that some of their proper temporal parts (e.g., their previous or future phases) may be not present. E.g., the piece of paper you are reading now is wholly present, while some temporal parts of your reading are not present any more. Philosophers say that endurants are entities that are in time, while lacking however temporal parts (so to speak, all their parts flow with them in time). Perdurants, on the other hand, are entities that happen in time, and can have temporal parts (all their parts are fixed in time).” (Gangemi et al. 2002, pp. 166-181).</p>
shortcut	<p>A shortcut is a formally defined single property that represents a deduction or join of a data path in the CIDOC CRM. The scope notes of all properties characterized as shortcuts describe in words the equivalent deduction. Shortcuts are introduced for the cases where common documentation practice refers only to the deduction rather than to the fully developed path. For example, museums often only record the dimension of an object</p>

without documenting the Measurement that observed it. The CIDOC CRM declares shortcuts explicitly as single properties in order to allow the user to describe cases in which he has less detailed knowledge than the full data path would need to be described. For each shortcut, the CIDOC CRM contains in its schema the properties of the full data path explaining the shortcut.

monotonic reasoning	Monotonic reasoning is a term from knowledge representation. A reasoning form is monotonic if an addition to the set of propositions making up the knowledge base never determines a decrement in the set of conclusions that may be derived from the knowledge base via inference rules. In practical terms, if experts enter subsequently correct statements to an information system, the system should not regard any results from those statements as invalid, when a new one is entered. The CIDOC CRM is designed for monotonic reasoning and so enables conflict-free merging of huge stores of knowledge.
disjoint	Classes are disjoint if the intersection of their extensions is an empty set. In other words, they have no common instances in any possible world.
primitive	The term primitive as used in knowledge representation characterizes a concept that is declared and its meaning is agreed upon, but that is not defined by a logical deduction from other concepts. For example, mother may be described as a female human with child. Then mother is not a primitive concept. Event however is a primitive concept. Most of the CIDOC CRM is made up of primitive concepts.
Open World	The “Open World Assumption” is a term from knowledge base systems. It characterizes knowledge base systems that assume the information stored is incomplete relative to the universe of discourse they intend to describe. This incompleteness may be due to the inability of the maintainer to provide sufficient information or due to more fundamental problems of cognition in the system’s domain. Such problems are characteristic of cultural information systems. Our records about the past are necessarily incomplete. In addition, there may be items that cannot be clearly assigned to a given class . In particular, absence of a certain property for an item described in the system does not mean that this item does not have this property. For example, if one item is described as Biological Object and another as Physical Object, this does not imply that the latter may not be a Biological Object as well. Therefore, complements of a class with respect to a superclass cannot be concluded in general from an information system using the Open World Assumption. For example, one cannot list “all Physical Objects known to the system that are not Biological Objects in the real world”, but one may of course list “all items known to the system as Physical Objects but that are not known to the system as Biological Objects”.
complement	The complement of a class A with respect to one of its superclasses B is the set of all instances of B that are not instances of A. Formally, it is the set-theoretic difference of the extension of B minus the extension of A. Compatible extensions of the CIDOC CRM should not declare any class with the intension of them being the complement of one or more other classes. To do so will normally violate the desire to describe an Open World . For example, for all possible cases of human gender, male should not be declared as the complement of female or vice versa. What if someone is both or even of another kind?
query containment	Query containment is a problem from database theory: A query X contains another query Y, if for each possible population of a database the answer set to query X contains also the answer set to query Y. If query X and Y were classes, then X would be superclass of Y.

interoperability Interoperability means the capability of different information systems to communicate some of their contents. In particular, it may mean that

- 1 two systems can exchange information, and/or
- 2 multiple systems can be accessed with a single method.

Generally, syntactic interoperability is distinguished from **semantic interoperability**. Syntactic interoperability means that the information encoding of the involved systems and the access protocols are compatible, so that information can be processed as described above without error. However, this does not mean that each system processes the data in a manner consistent with the intended meaning. For example, one system may use a table called "Actor" and another one called "Agent". With syntactic interoperability, data from both tables may only be retrieved as distinct, even though they may have exactly the same meaning. To overcome this situation, semantic interoperability has to be added. The CIDOC CRM relies on existing syntactic interoperability and is concerned only with adding *semantic interoperability*.

semantic interoperability Semantic **interoperability** means the capability of different information systems to communicate information consistent with the intended meaning. In more detail, the intended meaning encompasses

- 1 the data structure elements involved,
- 2 the terminology appearing as data and
- 3 the identifiers used in the data for factual items such as places, people, objects etc.

Obviously, communication about data structure must be resolved first. In this case consistent communication means that data can be transferred between data structure elements with the same intended meaning or that data from elements with the same intended meaning can be merged. In practice, the different levels of generalization in different systems do not allow the achievement of this ideal. Therefore, semantic interoperability is regarded as achieved if elements can be found that provide a reasonably close generalization for the transfer or merge. This problem is being studied theoretically as the **query containment** problem. The CIDOC CRM is only concerned with semantic interoperability on the level of data structure elements.

property quantifiers We use the term "property quantifiers" for the declaration of the allowed number of **instances** of a certain **property** that can refer to a particular instance of the **range** class or the **domain** class of that property. These declarations are ontological, i.e., they refer to the nature of the real world described and not to our current knowledge. For example, each person has exactly one father, but collected knowledge may refer to none, one or many.

universal The fundamental ontological distinction between universals and particulars can be informally understood by considering their relationship with instantiation: particulars are entities that have no **instances** in any possible world; universals are entities that do have instances. **Classes** and **properties** (corresponding to predicates in a logical language) are usually considered to be universals. (after Gangemi et al. 2002, pp. 166-181).

knowledge creation process All knowledge contained in an information system must have been introduced into that system by some human agent, either directly or indirectly. Despite this fact, many, if not most, statements within such a system will lack specific attribution of authority. That being said, in the domain of cultural heritage, it is common practice that, for the processes of collection documentation and management, there are clearly and explicitly elaborated systems of responsibility outlining by whom and how knowledge can be added and/or modified in the system. Ideally these systems are specified in institutional policy and

protocol documents. Thus, it is reasonable to hold that all such statements that lack explicit authority attribution within the information system can, in fact, be read as the official view of the administrating institution of that system.

Such a position does not mean to imply that an information system represents at any particular moment a completed phase of knowledge that the institution promotes. Rather, it means to underline that, in a CH context, a managed set of data, at any state of elaboration, will in fact embody an adherence to some explicit code of standards which guarantees the validity of that data within the scope of said standards and all practical limitations. So long as the information is under active management it remains continuously open to revision and improvement as further research reveals further understanding surrounding the objects of concern.

A distinct exception to this rule is represented by information in the data set that carries with it an explicit statement of responsibility.

In CIDOC CRM such statements of responsibility are expressed through knowledge creation events such as E13 Attribute Assignment and its relevant subclasses. Any information in a CIDOC CRM model that is based on an explicit creation event for that piece of information, where the creator's identity has been given, is attributed to the authority and assigned to the responsibility of the actor identified as causal in that event. For any information in the system connected to knowledge creation events that do not explicitly reference their creator, as well as any information not connected to creation events, the responsibility falls back to the institution responsible for the database/knowledge graph. That means that for information only expressed through shortcuts such as *P2 has type*, where no knowledge creation event has been explicitly specified, the originating creation event cannot be deduced and the responsibility for the information can never be any other body than the institution responsible for the whole information system.

In the case of an institution taking over stewardship of a database transferred into their custody, two relations of responsibility for the knowledge therein can be envisioned. If the institution accepts the dataset and undertakes to maintain and update it, then they take on responsibility for that information and become the default authority behind its statements as described above. If, on the other hand, the institution accepts the data set and stores it without change as a closed resource, then it can be considered that the default authority remains the original steward.

transitivity

Transitivity is defined in the standard way found in mathematics or logic: A property P is transitive if the domain and range is the same class and for all instances x, y, z of this class the following is the case: If x is related by P to y and y is related by P to z, then x is related by P to z. The intention of a property as described in the scope note will decide whether a property is transitive or not. For example, the property *P121 overlaps with* between instances of E53 Place is not transitive, while the property *P89 falls within (contains)* between instances of E53 Place and the property *P46 is composed of (forms part of)* between instances of E18 Physical Thing are both transitive. Transitivity is especially useful when CIDOC CRM is implemented in a system with deduction.

symmetry

Symmetry is defined in the standard way found in mathematics or logic: A property P is symmetric if the domain and range are the same class and for all instances x, y of this class the following is the case: If x is related by P to y, then y is related by P to x. The intention of a property as described in the scope note will decide whether a property is symmetric or not. An example of a symmetric property is E53 Place. *P122 borders with: E53 Place*. The names of symmetric properties have no parenthetical form, because reading in the range-to-domain direction is the same as the domain-to-range reading.

reflexivity Reflexivity is defined in the standard way found in mathematics or logic: A property P is reflexive if the domain and range are the same class and for all instances x, of this class the following is the case: x is related by P to itself. The intention of a property as described in the scope note will decide whether a property is reflexive or not. An example of a reflexive property is E53 Place. *P89 falls within (contains):* E53 Place.

Applied Form

The CIDOC CRM is an ontology in the sense used in computer science. It has been expressed as an object-oriented semantic model, in the hope that this formulation will be comprehensible to both documentation experts and information scientists alike, while at the same time being readily converted to machine-readable formats such as RDF Schema or OWL. [A CRM conformant documentation system can be implemented using RDF Schema or OWL, but also in Relational or Object-Oriented schema. CIDOC CRM instances can be encoded in RDF, JSON LD, XML, OWL and others.](#)

[More specifically, the CIDOC CRM is expressed in terms of the primitives of semantic data modelling. As such, it consists of:](#)

- [classes, which represent general notions in the domain of discourse, such as the CIDOC CRM class E21 Person which represents the notion of person;](#)
- [properties, which represent the binary relations that link the individuals in the domain of discourse, such as the CIDOC CRM property P152 has parent linking a person to one of the person's parent.](#)
- [properties of properties, such as the property P14.1 in the role of, of the CIDOC CRM property P14 carried out by \(see also section "About Types"\). They do not appear in the property hierarchy list, but are included as part of their base property declaration and are referred to in the class declarations. They all have the implicit quantification "many to many" \(see also section "Property Quantifiers"\)It can be implemented in Relational or Object-Oriented schema. CIDOC CRM instances can also be encoded in RDF, JSON LD, XML, OWL among and others](#)

Although the definition of the CIDOC CRM provided here is complete, it is an intentionally compact and concise presentation of the CIDOC CRM's 81 classes and 160 unique properties. It does not attempt to articulate the inheritance of properties by subclasses throughout the class hierarchy (this would require the declaration of several thousand properties, as opposed to 160). However, this definition does contain all of the information necessary to infer and automatically generate a full declaration of all properties, including inherited properties.

Naming Conventions

The following naming conventions have been applied throughout the CIDOC CRM:

- Classes are identified by numbers preceded by the letter "E" (historically classes were sometimes referred to as "Entities"), and are named using noun phrases (nominal groups) using title case (initial capitals). For example, E63 Beginning of Existence.
- Properties are identified by numbers preceded by the letter "P," and are named in both directions using verbal phrases in lower case. Properties with the character of states are named in the present tense, such as "has type", whereas properties related to events are named in past tense, such as "carried out." For example, P126 employed (was employed in).
- Property names should be read in their non-parenthetical form for the domain-to-range direction, and in parenthetical form for the range-to-domain direction. Reading a property in range-to-domain direction is equivalent to the inverse of that property. Following a current notational practice in OWL knowledge

Formatted: Body Text, Indent: Before: 0.13", Hanging: 0.13", Outline numbered + Level: 1 + Numbering Style: Bullet + Aligned at: 0.25" + Tab after: 0" + Indent at: 0.5"

Formatted: Body Text, Indent: Before: 0.13", Hanging: 0.13", Outline numbered + Level: 1 + Numbering Style: Bullet + Aligned at: 0.25" + Tab after: 0" + Indent at: 0.5"

Formatted: Body Text, Indent: Before: 0.08", Hanging: 0.16", Tab stops: 0.24", List tab

representation language, we represent inverse properties in this text by adding a letter “i” following the identification number and the parenthetical form of the full property name, such as *P59i is located on or within*, which is the inverse of *P59 has section (is located on or within)*.

- Properties with a range that is a subclass of E59 Primitive Value (such as E1 CRM Entity. *P3 has note*: E62 String, for example) have no parenthetical name form, because reading the property name in the range-to-domain direction is not regarded as meaningful.
- Properties that have identical domain and range are either symmetric or transitive. Instantiating a symmetric property implies that the same relation holds for both the domain-to-range and the range-to-domain directions. An example of this is E53 Place. *P122 borders with*: E53 Place. The names of symmetric properties have no parenthetical form, because reading in the range-to-domain direction is the same as the domain-to-range reading. Transitive asymmetric properties, such as E4 Period. *P9 consist of (forms part of)*: E4 Period, have a parenthetical form that relates to the meaning of the inverse direction.
- The choice of the domain of properties, and hence the order of their names, are established in accordance with the following priority list:
 - Temporal Entity and its subclasses
 - Thing and its subclasses
 - Actor and its subclasses
 - Other
- Properties of properties are identified by “P”, followed by the number of the base property extended with “.1” and are named in one direction using a verbal phrase in lower case in the present tense. For example: the property *P62.1 mode of depiction of the property P62 depicts (is depicted by)*

Formatted: Body Text, Outline numbered + Level: 1 + Numbering Style: Bullet + Aligned at: 0.08" + Tab after: 0.24" + Indent at: 0.24"

Formatted: Body Text, Indent: Before: 0.13", Hanging: 0.13", Tab stops: 0.25", Left + Not at 0.24"

Inheritance and Transitivity

CIDOC CRM is formulated as a class system with inheritance. A property P with domain A and range B will also be a property between any possible subclasses of A and of B. In many cases there will be a common subclass C of both A and B. In these cases, when the property is restricted to C, that is, with C as domain and range, the restricted property could be transitive. For instance, an E73 Information Object can be incorporated into an E90 Symbolic Object and thus an information object can be incorporated in another information object.

In the definition of CIDOC CRM the transitive properties are explicitly marked as such in the scope notes. All unmarked properties should be considered as not transitive.

Shortcuts

Some properties are declared as shortcuts of longer, more comprehensively articulated paths that connect the same domain and range classes as the shortcut property via one or more intermediate classes. For example, the property E18 Physical Thing. *P52 has current owner (is current owner of)*: E39 Actor, is a shortcut for a fully articulated path from E18 Physical Thing through E8 Acquisition to E39 Actor. An instance of the fully-articulated path always implies an instance of the shortcut property. However, the inverse may not be true; an instance of the fully-articulated path cannot always be inferred from an instance of the shortcut property inside the frame of the actual KB

The class E13 Attribute Assignment allows for the documentation of how the assignment of any property came about, and whose opinion it was, even in cases of properties not explicitly characterized as “shortcuts”.

About the logical expressions used in the CIDOC CRM

The present CIDOC CRM specifications are annotated with logical axioms, providing an additional formal expression of the CIDOC CRM ontology. This section briefly introduces the assumptions that are at the basis of

the logical expression of the CIDOC CRM (for a fully detailed account of the logical expression of semantic data modelling, see (Reiter,1984)).

The CIDOC CRM is expressed in terms of the primitives of semantic data modelling. As such, it consists of:

- ~~classes, which represent general notions in the domain of discourse, such as the CIDOC CRM class E21 Person which represents the notion of person;~~
- ~~properties, which represent the binary relations that link the individuals in the domain of discourse, such as the CIDOC CRM property P152 has parent linking a person to one of the person's parent.~~

~~In terms of semantic data modelling, classes and properties are used to express ontological knowledge by means of various kinds of constraints, such as sub-class/sub-property links, e.g., E21 Person is a sub-class of E20 Biological Object, or domain/range constraints, e.g., the domain of P152 has parent is class E21 Person.~~

In contrast, first-order logic-based knowledge representation relies on a language for formally encoding an ontology. This language can be directly put in correspondence with semantic data modelling in a straightforward way:

- classes are named by *unary predicate symbols*; conventionally, we use E21 as the unary predicate symbol corresponding to class E21 Person;
- properties are named by *binary predicate symbols*; conventionally, we use P152 as the binary predicate symbol corresponding to property P152 has parent.
- properties of properties, “.1 properties” are named by *ternary predicate symbols*; conventionally, we use P14.1 as the ternary predicate symbol corresponding to property P14.1 in the role of.

Ontology is expressed in logic by means of *logical axioms*, which correspond to the constraints of semantic modelling. In the definition of classes and properties of the CIDOC CRM the axioms are placed under the heading ‘In first order logic’. There are several options for writing statements in first order logic. In this document we use a standard compact notation widely used in text books and scientific papers. The definition is given in the table below.

Table 1: Symbolic Operators in First Order Logic Representation

Symbol	Name	reads	Truth value
Operators			
\wedge	conjunction	and	$(\varphi \wedge \psi)$ is true if and only if both φ and ψ are true
\vee	disjunction	or	$(\varphi \vee \psi)$ is true if and only if at least one of either φ or ψ is true
\neg	negation	not	$\neg\varphi$ is true if and only if φ is false
\Rightarrow	implication	implies, if ... then ...	$(\varphi \Rightarrow \psi)$ is true if and only if it is not the case that φ is true and ψ is false
\Leftrightarrow	equivalence	is equivalent to, if ... and only if ...	$\varphi \Leftrightarrow \psi$ is true if and only if both φ and ψ are true or both φ and ψ are false
Quantifiers			
\exists	existential quantifier	exists, there exists at least one	
\forall	Universal quantifier	forall, for all	

For instance, the above sub-class link between E21 Person and E20 Biological Object can be formulated in first order logic as the axiom:

$(\forall x) [E21(x) \Rightarrow E20(x)]$

(reading: for all individuals x, if x is a E21 then x is an E20).

In the definitions of classes and properties in this document the universal quantifier(s) are omitted for simplicity, so the above axiom is simply written:

$E21(x) \Rightarrow E20(x)$

Likewise, the above domain constraint on property *P152 has parent* can be formulated in first order logic as the axiom:

$P152(x,y) \Rightarrow E21(x)$

(reading: for all individuals x and y, if x is a P152 of y, then x is an E21).

Properties of properties, indicated by a '.1' after the property number are described as ternary predicate symbols. For example, the property P14.1 in the role of is described as the ternary predicate symbol corresponding to property P14 carried out by (performed) :

$P14(x,y) \Rightarrow E7(x)$

$P14(x,y) \Rightarrow E39(y)$

$P14(x,y,z) \Rightarrow [P14(x,y) \wedge E55(z)]$

These basic considerations should be used by the reader to understand the logical axioms that are used into the definition of the classes and properties. Further information about the first order formulation of CIDOC CRM can be found in (Meghini & Doerr, 2018)

Property Quantifiers

Quantifiers for properties are provided for the purpose of semantic clarification only, and should **not** be treated as implementation recommendations. The CIDOC CRM has been designed to accommodate alternative opinions and incomplete information, and therefore **all** properties should be implemented as optional and repeatable for their domain and range (“many to many (0,n:0,n)”). Therefore, the term “cardinality constraints” is avoided here, as it typically pertains to implementations.

The following table lists all possible property quantifiers occurring in this document by their notation, together with an explanation in plain words. In order to provide optimal clarity, two widely accepted notations are used redundantly in this document, a verbal and a numeric one. The verbal notation uses phrases such as “one to many”, and the numeric one, expressions such as “(0,n:0,1)”. While the terms “one”, “many” and “necessary” are quite intuitive, the term “dependent” denotes a situation where a range instance cannot exist without an instance of the respective property. In other words, the property is “necessary” for its range. (Meghini, C. & Doerr, M., 2018)

many to many (0,n:0,n)	Unconstrained: An individual domain instance and range instance of this property can have zero, one or more instances of this property. In other words, this property is optional and repeatable for its domain and range.
one to many (0,n:0,1)	An individual domain instance of this property can have zero, one or more instances of this property, but an individual range instance cannot be referenced by more than one instance of this property. In other words, this property is optional for its domain and range, but repeatable for its domain only. In some contexts, this situation is called a “fan-out”.
many to one (0,1:0,n)	An individual domain instance of this property can have zero or one instance of this property, but an individual range instance can be referenced by zero, one or more instances of this property. In other words, this property is optional for its domain and range, but repeatable for its range only. In some contexts, this situation is called a “fan-in”.

many to many, necessary (1,n:0,n)	An individual domain instance of this property can have one or more instances of this property, but an individual range instance can have zero, one or more instances of this property. In other words, this property is necessary and repeatable for its domain, and optional and repeatable for its range.
one to many, necessary (1,n:0,1)	An individual domain instance of this property can have one or more instances of this property, but an individual range instance cannot be referenced by more than one instance of this property. In other words, this property is necessary and repeatable for its domain, and optional but not repeatable for its range. In some contexts, this situation is called a “fan-out”.
many to one, necessary (1,1:0,n)	An individual domain instance of this property must have exactly one instance of this property, but an individual range instance can be referenced by zero, one or more instances of this property. In other words, this property is necessary and not repeatable for its domain, and optional and repeatable for its range. In some contexts, this situation is called a “fan-in”.
one to many, dependent (0,n:1,1)	An individual domain instance of this property can have zero, one or more instances of this property, but an individual range instance must be referenced by exactly one instance of this property. In other words, this property is optional and repeatable for its domain, but necessary and not repeatable for its range. In some contexts, this situation is called a “fan-out”.
one to many, necessary, dependent (1,n:1,1)	An individual domain instance of this property can have one or more instances of this property, but an individual range instance must be referenced by exactly one instance of this property. In other words, this property is necessary and repeatable for its domain, and necessary but not repeatable for its range. In some contexts, this situation is called a “fan-out”.
many to one, necessary, dependent (1,1:1,n)	An individual domain instance of this property must have exactly one instance of this property, but an individual range instance can be referenced by one or more instances of this property. In other words, this property is necessary and not repeatable for its domain, and necessary and repeatable for its range. In some contexts, this situation is called a “fan-in”.
one to one (1,1:1,1)	An individual domain instance and range instance of this property must have exactly one instance of this property. In other words, this property is necessary and not repeatable for its domain and for its range.

The CIDOC CRM defines some dependencies between properties and the classes that are their domains or ranges. These can be one or both of the following:

- the property is necessary for the domain
- the property is necessary for the range, or, in other words, the range is dependent on the property.

The possible kinds of dependencies are defined in the table above. Note that if a dependent property is not specified for an instance of the respective domain or range, it means that the property exists, but the value on one side of the property is unknown. In the case of optional properties, the methodology proposed by the CIDOC CRM does not distinguish between a value being unknown or the property not being applicable at all. For example, one may know that an object has an owner, but the owner is unknown. In a CIDOC CRM instance this case cannot be distinguished from the fact that the object has no owner at all. Of course, such details can always be specified by a textual note.

Note that the quantification of all properties of properties, “.1” properties, is “many-to-many” and, therefore, does not appear explicitly in their definitions.

Modelling principles

The following modelling principles have guided and informed the development of the CIDOC CRM.

Reality, Knowledge Bases and CIDOC CRM

The CIDOC CRM is a formal ontology in the sense introduced by (Guarino, 1998).⁴ The present document is intended to embrace an audience not specialized in computer science and logic; therefore, it focuses on the informal semantics and on the pragmatics of the CIDOC CRM concepts, offering a detailed discussion of the main traits of the conceptualization underlying the CIDOC CRM through basic usage patterns.⁵ The CIDOC CRM aims to assist sharing, connecting and integrating information from research about the past. In order to understand the function of a formal ontology of this kind, one needs to make the following distinctions:

- The *material reality*. For the purpose of the CIDOC CRM, material reality is regarded as whatever has substance that can be perceived with senses or instruments. Examples are people, a forest or a settlement environment, sea, atmosphere, distant celestial or cellular micro structures, including what we assume could be potentially or theoretically perceived if we could be there, such as the center of Earth or the sun, and all that is past. It is constrained to space and time. What goes on in *our minds* or is produced by our minds is also regarded as part of the material reality, as it becomes materially evident to other people at least by our utterances, behavior and products.
- The units of description or *particulars*, i.e., the things and relations which we refer to in order to distinguish parts of reality. Examples are Mount Ida, the Taj Mahal, the formation of China by emperor Qin Shi Huang (秦始皇) in 221BC, Tut-Ankh Amun and his embalming, Prince Shotoku of Japan sending a mission to China in 607AD, the participation of Socrates in the Battle of Potidaea or the radiocarbon dating of the Iceman Ötzi (Kutschera, 2002).

A formal ontology, such as the CIDOC CRM, constitutes a controlled language for talking about particulars. I.e., it provides classes and properties for categorizing particulars as so-called “instances” in a way that their individuation, unity and relevant properties are as unambiguous as possible. For instance, Tut-Ankh Amun as instance of E21 Person *is* the real pharaoh from his birth to death, and not extending to his mummy, as follows from the specification of the class E21 Person and its properties in the CIDOC CRM.

For clarification, the CIDOC CRM does not take a position against or in favour of the existence of spiritual substance nor of substance not accessible by either senses or instruments, nor does it suggest a materialistic philosophy. However, for practical reasons, it relies on the priority of integrating information based on material evidence available for whatever human experience. The CIDOC CRM only commits to a unique material reality independent from the observer.

When we *provide descriptions* of particulars, we need to refer to them by unique names, titles or constructed identifiers, all of which are instances of E41 Appellation in the CIDOC CRM, in order the reference to be independent of the context. (In contrast, reference to particulars by pronouns or enumerations of characteristic properties, such as name and birth date, are context dependent). The appellation, and the relation between the appellation and the referred item or relationship, must not be confused with the referred item and its identity. For example, Tut-Ankh Amun the name (instance of E41 Appellation) is different from Tut-Ankh Amun the person (instance of E21 Person) and also different from the relationship between name and person (*PI is identified by*). Instances of CIDOC CRM classes are the *real* particulars, not their names, but in descriptions, names must be used as surrogates for the real things meant. Particulars are approximate individuations, like sections, of parts of

⁴ Nicola Guarino defines a formal ontology as a specification of a set of named concepts used to describe and approximate a part of reality, plus a first-order logical theory narrowing down the intended meaning of the named concepts.

⁵ For the readers interested in computer science and logic, the syntax and formal semantics employed by the CIDOC CRM are given in (Meghini & Doerr 2018), where the computational aspects are also discussed.

reality. In other words, the uniqueness of reality does not depend on where one draws the line between the mountain and the valley.

A CIDOC CRM-compatible *knowledge base* (KB) (Meghini & Doerr 2018) is an instance of E73 Information Object in the CIDOC CRM. It contains (data structures that encode) formal statements representing propositions believed to be true in a reality by an observer. These statements use appellations (e.g., <http://id.loc.gov/authorities/names/n79066005>⁶) of ontological particulars and of CRM concepts (e.g., *P100i died in*). Thereby users, in their capacity of having real-world knowledge and cognition, may be able to relate these statements to the propositions they are meant to characterize, and be able to reason and research about their validity. In other words, the formal instances in a knowledge base are the *identifiers*, not the real things or phenomena. A special case is digital content: a KB in a computer system may contain statements about instances of E90 Symbolic Object and the real thing may be text residing within the same KB. The instance of E90 Symbolic Object and its textual representation are separate entities and they can be connected with the property *P190 has symbolic content*.

Therefore, a knowledge base does not contain knowledge, but *statements that represent* knowledge, as long as there exist people that can resolve the identifiers used to their referents. (Appellations described in a knowledge base, and not used as primary substitutes of other items, are of course explicitly declared as instances of E41 Appellation in the knowledge base.)

Authorship of Knowledge Base Contents

This section describes a recommended good practice how to relate authority to knowledge base contents.

Statements in a KB must have been inserted by some human agent, either directly or indirectly. However, these statements often make no reference to that agent, lacking attribution of authority. An example of such statements in the CIDOC CRM is information expressed through shortcuts such as *P2 has type*. In the domain of cultural heritage, it is common practice that the responsibility for maintaining knowledge in the KB is elaborated in institutional policy or protocol documents. Thus, it is reasonable to hold that statements which lack explicit authority attribution can be read as the official view of the administrating institution of that system, i.e., the maintainers of the KB. This does not imply that the knowledge described in the KB is complete. So long as the information is under active management, it remains continuously open to revision and improvement as further research reveals further understandings.⁷ A KB does not represent a slice of reality, but the justified beliefs of its maintainers about that reality. For simplicity, we speak about a KB as representing some reality.

Statements in a KB may also carry explicit references to agents that produced them, i.e., further statements of responsibility. In CIDOC CRM such statements of responsibility are expressed through knowledge creation events such as E13 Attribute Assignment and its relevant subclasses. Any knowledge that is about an explicit knowledge creation event, where the creator's identity has been given, is implicitly attributed to be correctly referred to in the KB by the maintaining authority, whereas the responsibility for the content created by that event is assigned to the agent identified as causal to that event.

In the special case of an institution taking over stewardship of a database transferred into their custody, two relations of responsibility for the knowledge therein can be envisioned. If the institution accepts the dataset and undertakes to maintain and update it, then they take on responsibility for that information and become the default authority behind its statements as described above. If, on the other hand, the institution accepts the data set and stores it without change as a closed resource, then it can be considered that the default authority remains the original steward like for any other scholarly document kept by the institution.

⁶ The URI (instance of E41 Appellation) of the Library of Congress for Tut-Ankh-Amun, the pharaoh.

⁷ Statements in a KB may be in contradiction to the ontologically defined quantification of properties without the KB being broken or invalid in any sense, either because necessary properties are unknown or there exist good reasons to assume alternative values for properties with limited cardinality, be it by the same or by different maintainers.

Extensions of CIDOC CRM

Since the intended scope of the CIDOC CRM is a subset of the “real” world and is therefore potentially infinite, the model has been designed to be extensible through the linkage of compatible external type hierarchies.

Of necessity, some concepts covered by the CIDOC CRM are defined in less details than others: E39 Actor and E30 Right, for example. This is a natural consequence of staying within the model’s clearly articulated practical scope in an intrinsically unlimited domain of discourse. These ‘underdeveloped’ concepts can be considered as candidate superclasses for compatible extensions, in particular for disciplines with a respective focus. Additions to the model are known as extensions while the main model is known as CRMbase.

Compatibility of extensions with the CRM means that data structured according to an extension must also remain valid as instances of CIDOC CRM base classes. In practical terms, this implies query containment: any queries based on CIDOC CRM concepts to a KB should retrieve a result set that is correct according to the model’s semantics, regardless of whether the KR is structured according to the CIDOC CRM’s semantics alone, or according to the CIDOC CRM plus compatible extensions. For example, a query such as “list all events” should recall 100% of the instances deemed to be events by the CIDOC CRM, regardless of how they are classified by the extension.

A sufficient condition for the compatibility of an extension with the CIDOC CRM is that its classes, other than E1 CRM Entity, subsume all classes of the extension, and all properties of the extension are either subsumed by CRM properties, or are part of a path for which a CIDOC CRM property is a shortcut, and that classes and properties of the extension can be well distinguished from those in the CIDOC CRM. For instance, a class “tangible object” may be in conflict with existing classes of the CIDOC CRM. Obviously, such a condition can only be tested intellectually.

The CRM provides a number of mechanisms to ensure that coverage of the intended scope can be increased on demand without losing compatibility:

- 1 Existing classes can be extended, either structurally as subclasses or dynamically using the type hierarchy (see section About Types below).
- 2 Existing properties can be extended, either structurally as subproperties, or in some cases, dynamically, using properties of properties which allow subtyping (see section About Types below).
- 3 Additional information that falls outside the semantics formally defined by the CIDOC CRM can be recorded as unstructured data using E1 CRM Entity, *P3 has note*: E62 String.
- 4 Extending the CIDOC CRM by superclasses and properties that pertain to a wider scope. They are called conservative extensions, if they preserve backwards compatibility with instances described with the CIDOC CRM.

Following strategies 1, 2 and 3 will have the result that the CIDOC CRM concepts subsume and thereby cover the extensions. This means that querying an extended knowledge base only with concepts of the CIDOC CRM will nevertheless retrieve all facts described via the extensions.

In mechanism 3, the information in the notes is accessible in the respective knowledge base by retrieving the instances of E1 CRM Entity that are domain of *P3 has note*. Keyword search will also work for the content of the note. Rules should be applied to attach a note to the item most specific for the content. For instance, details about the role of an actor in an activity should be associated with the instance of E7 Activity, and not with the instance of E39 Actor. This approach is preferable when queries relating elements from the content of such notes across the knowledge base are not expected.

In general, only concepts to be used for selecting multiple instances from the knowledge base by formal querying need to be explicitly modelled. This criterion depends on the expected scope and use of the particular knowledge base. The CIDOC CRM prioritizes modelling the kinds of facts one would like to retrieve and relate

from heterogeneous content sources, potentially from different institutions. It does not, by way of contrast, focus on the modelling of facts with a more local scope such as the administrative practices internal to an institution.

Mechanism 4, conservative extension, is more complex:

With increasing use of the CIDOC CRM, there is also a need for extensions that model phenomena from a scope wider than the original one of the CIDOC CRM, but which are also applicable to the concepts that do fall within the CIDOC CRM's scope. When this occurs, properties of the CIDOC CRM may be found to be applicable more generally to superclasses of the extension than to those of their current domain or range in the CIDOC CRM.

This is a consequence of the key principle of the CIDOC CRM to model "bottom up", i.e., selecting the domains and ranges for properties to be as narrow as they would apply in a well understood fashion in the current scope, thus avoiding making poorly understood generalizations at risk of requiring non-monotonic correction.

The fourth mechanism for extending the CIDOC CRM by conservation extension can be seen to be split into two cases:

- 1 A new class or property is added to an extension of the CIDOC CRM, which is not covered by superclasses other than E1 CRM Entity or a superproperty in the CIDOC CRM respectively. In this case, all facts described only by such concepts are not accessible by queries with CIDOC CRM concepts. Therefore, the extension should publish in a compatibility statement the additional relevant high-level classes and properties needed to retrieve all facts documented with the extended model. This case is a monotonic extension.
- 2 The domain or range of an existing property in the CIDOC CRM is changed to a superclass of the one or the other or both, because the property is understood to be applicable beyond its originally anticipated scope. In this case, all facts described by the extension are still accessible by querying with the concepts of the CIDOC CRM, but the extension can describe additional facts that the CIDOC CRM could not. This case is a monotonic extension and generally recommended, because it enables bottom-up evolution of the model. If this change is part of a new release of the CIDOC CRM itself, it is simply backwards compatible, and this has been done frequently in the evolution of this model.

If case (2) should be documented and implemented in an extension module **separate from** the CIDOC CRM, it may come in conflict with the current way knowledge representation languages, such as RDF/OWL, treat it, because in formal logic changing the range or domain of a property is regarded **as** changing the ontological meaning **completely**; there is no distinction between **the meaning of the property independent of domain and range and the specification of the domain and range**. It is, however, similar to what in logic is called a conservative extension of a theory, and necessary for an effective modular management of ontologies.

Therefore, for the interested reader, we describe here a definition of this case in terms of first order logic, which shows how modularity can formally be achieved:

Let us assume a property P defined with domain class A and range class C also holds for a domain class B, superclass of A, and a range class D, superclass of C, in the sense of its ontological meaning in the real world. We describe this situation by introducing an auxiliary formal property P', defined with domain class B and range class D, and apply the following logic:

$$\begin{aligned} A(x) &\Rightarrow B(x) \\ C(x) &\Rightarrow D(x) \\ P(x,y) &\Rightarrow A(x) \\ P(x,y) &\Rightarrow C(y) \\ P'(x,y) &\Rightarrow B(x) \\ P'(x,y) &\Rightarrow D(y) \end{aligned}$$

Then, P' is a conservative extension of P if: $A(x) \wedge C(y) \wedge P'(x,y) \Leftrightarrow P(x,y)$

In other words, a separate extension module may re-declare the respective property with another identifier, preferably using the same label, and implement the above rule.

Minimality

Although the scope of the CIDOC CRM is very broad, the model itself is constructed as economically as possible:

- CIDOC CRM classes and properties are either primitive, or they are key concepts in the practical scope.
- Complements of CIDOC CRM classes are not declared, because, considering the Open World principle, there are no properties for complements of a class (see Terminology and first consequence of Monotonicity).

A CIDOC CRM class is declared when:

- It is required as the domain or range of a property not appropriate to its superclass.
- It serves as a merging point of two CIDOC CRM class branches via multiple IsA (e.g., E25 Human-Made Feature). When the branch superclasses are used for multiple instantiation of an item, this item is in the intersection of the scopes. The class resulting from multiple IsA should be narrower in scope than the intersection of the scopes of the branch superclasses.
- It is useful as a leaf class (i.e., at the end of a CIDOC CRM branch) to domain communities building CIDOC CRM extensions or matching key domain classes from other models to the CIDOC CRM (e.g., E34 Inscription).

Monotonicity

The CIDOC CRM's primary function is to support the meaningful integration of information in an Open World. The adoption of the Open World principle means that the CIDOC CRM itself must remain fundamentally open and knowledge bases implemented using it should be flexible enough to receive new insights. At the model level, new classes and properties within the CIDOC CRM's scope may be found in the course of integrating more documentation records or when new kinds of relevant facts come to the attention of its maintainers. At the level of the KBs, the need to add or revise information may arise due to numerous external factors. Research may open new questions; documentation may be directed to new or different phenomena; natural or social evolution may reveal new objects of study.

It is the aim of the maintainers of the CIDOC CRM to respect the Open World principle and to follow the principle of monotonicity. Monotonicity requires that adding new classes and properties to the model or adding new statements to a knowledge base does not invalidate already modelled structures and existing statements.

A first consequence of this commitment, at the level of the model, is that the CIDOC CRM aims to be monotonic in the sense of Domain Theory. That is to say, the existing CIDOC CRM constructs and the deductions made from them should remain valid and well-formed, even as new constructs are added by extensions to the CIDOC CRM. Any extensions should be, under this method, backwards compatible with previous models. The only exception to this rule arises when a previous construct is considered objectively incorrect by the domain experts and thus subjected to corrective revision. Adopting the principle of monotonicity has active consequences for the basic manner in which classes and properties are designed and declared in the CIDOC CRM. In particular, it forbids the declaration of complement classes, i.e., classes solely defined by excluding instances of some other classes.

For example:

FRBRoo (Bekiari et al (eds). 2015) extends the CIDOC CRM. In version 2.4 of FRBRoo, F51 Name Use Activity was declared as a subclass to the CIDOC CRM class E7 Activity. This class was added in order to describe a phenomenon specific to library practice and not considered within CRM base. F51 Name Use Activity describes the practice of an instance of E74 Group adopting and deploying a name within a context for a time-span. The creation of this extension is monotonic because no existing IsA relationship or inheritance of properties in CRM base are compromised and no future extension is ruled out. By way of contrast, if, to handle this situation, a subclass "Other Activity" had been declared, a non-monotonic change would have been

introduced. This would be the case because the scope note of a complement class like “Other Activities” would forbid any future declaration of specializations of E7 Activity such as ‘Name Use Activity’. In the case the need arose to declare a particular specialized subclass, a non-monotonic revision would have to be made, since there would be no principled way to decide which instances of ‘Other Activity’ were instances of the new, specialized class and which were not. Such non-monotonic changes are extremely costly to end users, compromising backwards compatibility and long-term integration.

As a second consequence, maintaining monotonicity is also required during revising or augmenting data within a CIDOC CRM compatible system. That is, existing CIDOC CRM instances, their properties and the deductions made from them, should always remain valid and well-formed, even as new instances, regarded as consistent by the domain expert, are added to the system.

For example:

If someone describes correctly that an item is an instance of E19 Physical Object, and later it is correctly characterized as an instance of E20 Biological Object, the system should not stop treating it as an instance of E19 Physical Object. This is achieved by declaring E20 Biological Object as subclass of E19 Physical Object.

This example further demonstrates that the IsA hierarchy of classes and properties can represent characteristic stages of increasing knowledge about some item during the processes of investigation and collection of evidence. Higher level classes can be used to safely classify objects whose precise characteristics are not known in the first instance. An ambiguous biological object may, for example, be classified as only a physical object. Subsequent investigation can reveal its nature as a biological object. A knowledge base constructed with CIDOC CRM classes designed to support monotonic revision allows for seeking physical objects that were not yet recognized as biological ones. This ability to integrate information with different specificity of description in a well-defined way is particularly important for large-scale information integration. Such a system supports scholars being able to integrate all information about potentially relevant phenomena into the information system without forcing an over or under commitment to knowledge about the object. Since large scale information integration always deals with different levels of knowledge of its relevant objects, this feature enables a consistent approach to data integration.

A third consequence, applied at the level of the knowledge base, is that in order to formally preserve monotonicity, when it is required to record and store alternative opinions regarding phenomena all formally defined properties should be implemented as unconstrained (many: many) so that conflicting instances of properties are merely accumulated. Thus, integrated knowledge can serve as a research tool for accumulating relevant alternative opinions around well-defined entities, whereas conclusions about the truth are the task of open-ended scientific or scholarly hypothesis building.

For example:

King Arthur’s basic life events are highly contested. Once entered in a knowledge base, he should be defined as an instance of E21 Person and treated as having existed as such within the sense of our historical discourse. The instance of E21 Person is used as the collection point for describing possible properties and existence of this individual. Alternative opinions about properties, such as the birthplace and his living places, should be accumulated without validity decisions being made during data compilation. King Arthur may be entered as a different instance, of E28 Conceptual Object, for describing him as mythological character and accumulating possibly mythological facts.

The fourth consequence of monotonicity relates to the use of time dependent properties in a knowledge base. Certain properties declared in the CIDOC CRM, such as having a part, an owner or a location, may change many times for a single item during the course of its existence. Asserting that such a property holds for some item means that that property held for some particular, undetermined time-span within the course of its existence. Consequently, one item may be the subject of multiple statements asserting the instantiation of that property without conflict or need for revision. The collection of such statements would reflect an aggregation of these instances of this property holding over the time-span of the item’s existence. If a more specific temporal knowledge is required/available, it is recommended to explicitly describe the events leading to the assertion of

that property for that item. For example, in the case of acquiring or losing an item, it would be appropriate to declare the related event class such as E9 Move. By virtue of this principle, the CRM achieves monotonicity with respect to an increase of knowledge about the states of an item at different times, regardless of their temporal order.

Time-neutral properties may be specialized in a future monotonic extension by time-specific properties, but not vice-versa. Also, many properties registered do not change over time or are relative to events in the model already. Therefore, the CIDOC CRM always gives priority to modelling properties as time-neutral, and rather representing changes by events.

However, for some of these properties many databases may describe a “current” state relative to some property, such as “current location” or “current owner”. Using such a “current” state means that the database manager is able to verify the respective reality at the latest date of validity of the database. Obviously, this information is non-monotonic, i.e., it requires deletion when the state changes. In order to preserve a reduced monotonicity, these properties have time-neutral superproperties by which respective instances can be reclassified if the validity becomes unknown or no longer holds. Therefore, the use of such properties in the CRM is only recommended if they can be maintained consistently. Otherwise, they should be reclassified by their time-neutral superproperties. This holds in particular if data is exported to another repository, see also the paragraph “Authorship of Knowledge Base Contents”

Disjointness

Classes are disjoint if they cannot share any common instances at any time, past, present or future. That implies that it is not possible to instantiate an item using a combination of classes that are mutually disjoint or with subclasses of them (see “multiple instantiation” in section “Terminology”). There are many examples of disjoint classes in the CIDOC CRM.

A comprehensive declaration of all possible disjoint class combinations afforded by the CIDOC CRM has not been provided here; it would be of questionable practical utility, and may easily become inconsistent with the goal of providing a concise definition. However, there are two key examples of disjoint class pairs that are fundamental to effective comprehension of the CIDOC CRM:

- E2 Temporal Entity is disjoint from E77 Persistent Item. Instances of the class E2 Temporal Entity are perdurants, whereas instances of the class E77 Persistent Item are endurants. Even though instances of E77 Persistent Item have a limited existence in time, they are fundamentally different in nature from instances of E2 Temporal Entity, because they preserve their identity between events. Declaring endurants and perdurants as disjoint classes is consistent with the distinctions made in data structures that fall within the CIDOC CRM’s practical scope.
- E18 Physical Thing is disjoint from E28 Conceptual Object. The distinction is between material and immaterial items, the latter being exclusively human-made. Instances of E18 Physical Thing and E28 Conceptual Object differ in many fundamental ways; for example, the production of instances of E18 Physical Thing implies the incorporation of physical material, whereas the production of instances of E28 Conceptual Object does not. Similarly, instances of E18 Physical Thing cease to exist when destroyed, whereas an instance of E28 Conceptual Object perishes when it is forgotten or its last physical carrier is destroyed.

This page is left blank on purpose

Introduction to the basic concepts

The following paragraphs explain the most general logic of the CIDOC CRM. The CIDOC CRM is a formalized representation of historical discourse, a formal ontology. In this capacity, it is meant to support the (re)presentation of fact based, analytic discourse about what has happened in the past in a human understandable and machine-processable manner. It achieves this function by proposing a series of formalized properties (relations) and classes. The formalized properties support the making of semantically explicit statements relating classes of things. Their formal definition logically explicates the classes of things to which they may pertain. The CIDOC CRM properties thus enable a formal, logically explicit description of relations between individual, real world items, classified under distinct ontological classes. Encoding analytic data pertaining to the past under such a system of statements provides a standard representation for data and allows the uniform application of reasoning to large sets of data.

Grounding this high-level logic is a hierarchical system of classes and relations, that provide basic ontological distinctions by which to represent historical discourse. Familiarity with the basic ontological distinctions made in the top level of the class hierarchy provides the basic entry point to understanding how to apply the CIDOC CRM for knowledge representation.

The highest-level distinction in the CIDOC CRM is represented by the top-level concepts of E77 Persistent Item, equivalent to the philosophical notion of *endurant*; E2 Temporal Entity, equivalent to the philosophical notion of *perdurant* and, further, the concept of E92 Spacetime Volume.

As an event-centric model, supporting historical discourse, the CIDOC CRM firstly enables the description of entities that are themselves time-limited processes or evolutions within the passing of time using E2 Temporal Entity and its subclasses. Their basic function is to capture the fact of something having happened over time. In addition to allowing the description of a temporal duration, the subclasses of E2 Temporal Entity are used to document the historical relations between objects, similar to the role of action verbs in a natural language phrase. The more specific subclasses of E2 Temporal Entity enable the documentation of events pertaining to individually related/affected material, social or mental objects that have been described using subclasses of E77 Persistent Item. This precise documentation is enabled through the use of specialized properties formalizing the manner of the relation or affect. Examples of specific subclasses of E2 Temporal Entity include E12 Production, which allows the representation of events of making things by humans, and E5 Event which allows the documentation, among other things, of geological events and large-scale social events such as a war. Each of these subclasses have specific properties associated to them which allow them to function to represent the specific, real world connection between instances of E77 Persistent Item, such as the relation of an object to its time of production through *P108 was produced by* (E12) or the relation of a place to a geological phenomenon through *P7 was place of* (E5). The entities that E2 Temporal Entity documents, being time limited processes / occurrences, are such that their existence can be declared only on the basis of direct observation or recording of the event, or indirect observation of its material outcomes. Evidence of such entities may be preserved on material objects that are permanently changed because of them. Likewise, events may have been recorded in text or remembered through oral history. E2 Temporal Entity and its subclasses are central to the CRM and essential for almost all modelling tasks (e.g., in a museum catalogue one cannot consider an object outside its production event).

The real-world entities, which the event centric modelling of the CIDOC CRM aims to enable the accurate historical description of, are captured through E77 Persistent Item and its subclasses. E77 Persistent Item is used to describe entities that are relatively stable in form through the passage of time, maintaining a recognizable identity because their significant properties do not change. Specific subclasses of E77 Persistent Item can illustrate this point. E22 Human-Made Object is used for the description of discrete, physical objects having been produced by human action, such as an artwork or monument. An artwork or monument is persistent with regards to its physical constitution. So long as it retains its general physical form, it is said to exist and to participate in the flow of historical events. E28 Conceptual Object is also used to describe persistent items, but of a mental character. It is used to describe identifiable ideas that are named and form an object of historical

discourse. Its identity conditions rely in having a carrier by which it can be recalled. The entities described by E77 Persistent Item are prone to change through human activity, biological, geological or environmental processes, but are regarded to continue to exist and be the same just as long as such changes do not alter their basic identity (essence) as defined in the scope note of the relevant class.

The notion of identity is key in the application of CIDOC CRM. The properties and relations it provides are designed to allow the accurate historical description of the evolution of real-world items through time. This being the case, classes and properties are created in order to provide a definition, which will allow the accurate application of the classes or properties to the same real-world items by diverse users. Identity, in the sense of the CIDOC CRM, therefore, means that informed people are able to agree that they refer to the same, single thing in its distinction from others, both in its extent and over its time of existence. The criteria for such a determination should come from understanding the scope note of the respective CIDOC CRM class this thing is regarded to be an instance of, because communication via information systems may not leave space for respective clarifying dialogues between users. For example, the Great Sphinx of Giza may have lost part of its nose, but there is no question that we are still referring to the same monument as that before the damage occurred, since it continues to represent significant characteristics and distinctness from an overall shaping in the past, which is of archaeological relevance. Things lacking sufficient stability or differentiation, such as atmosphere, soil, clouds, waves, are not instances of E77 Persistent Item, and not suited for information integration. Discourse about such items may be documented with concepts of the CIDOC CRM as observations in relation to things of persistent identity, such as places.

Learning to distinguish and then interrelate instances of E77 Persistent Item (endurants) and instances of E2 Temporal Entity (perdurants) using the appropriate properties is key to the proper understanding and application of CIDOC CRM in order to formally represent analytic historical data. In the large majority of cases, the distinction this provides, and the subsequent elaboration of subclasses and properties is adequate to describe the content of database records in the cultural and scientific heritage domain. In exceptional cases, where we need to consider complex combinations of changes of spatial extent over time, the concept of spacetime (E92 Spacetime Volume) also needs to be considered. E92 Spacetime Volume describes the entities whose substance has or is an identifiable, confined geometrical extent in the material world that may vary over time, fuzzy boundaries notwithstanding. For example, the built settlement structure of the city of Athens is confined both from the point of view of time-span (from its founding until now) and from its changing geographical extent over the centuries, which may become more or less evident from current observation, historical documents and excavations. Even though E92 Spacetime Volume is an important theoretical part of the model, it can be ignored for most practical documentation and modelling tasks.

The key to the proper understanding of CIDOC CRM comes through the appropriation of its basic divisions and the logic these represent. It is important to underline that the CIDOC CRM is not intended to function as a classification system or vocabulary tool. The basic class divisions in CIDOC CRM are declared in order to be able to apply distinct properties to these classes and, in so doing, formulate precise, analytic propositions that represent historical realities. The expressive power of CIDOC CRM comes not from the application of classes to classify entities but in the documenting the interrelation of individual historical items through well-defined properties. These properties characteristically cover subjects such as relations of *identifying* items by names and identifiers; *participation* of persistent items in temporal entities; *location* of temporal entities and physical things in space and time; relations of *observation* and assessment; part-decomposition and *structural* properties of anything; *influence* of things and experiences on the activities of people and their products; *reference* of information objects to anything.

We explain these concepts with the help of graphical representations in the next sections.

Relations with Events

Figure 1 illustrates the minimal properties in the CIDOC CRM for documenting “what has happened”, the central pattern of the Model. Let us first consider the class E1 CRM Entity, the formal top class of the model. It primarily serves a technical purpose to aggregate the ontologically meaningful concepts of the model. It declares

however two important properties of general validity and distinct features of the Model: *P1 is identified by*, with range E41 Appellation, makes the fundamental ontological distinction between the identity of a particular and an identifier (see section “Reality, Knowledge Bases and CIDOC CRM” above), and in practice allows for describing a discourse about resolving historical ambiguities of names and reconciliation of multiple identifiers. The property *P2 has type*, with range E55 Type, constitutes a practical interface for refining classes by terminologies, being often volatile, as detailed in the section “About Types” below.

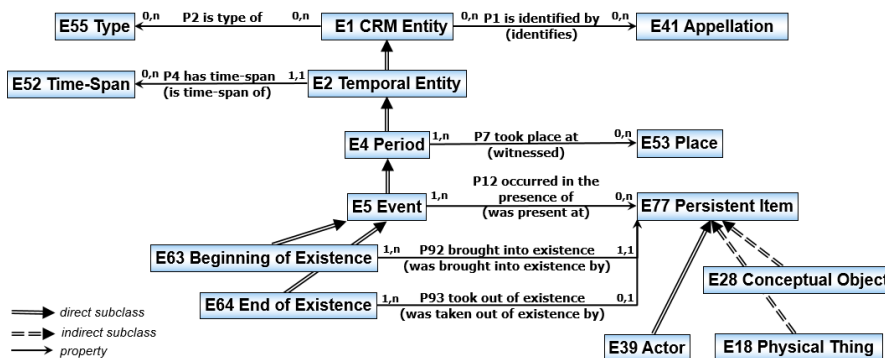

Figure 1: High Level Properties and Classes of CIDOC CRM

All classes in figure 1 are direct or indirect subclasses of E1 CRM Entity, but for better readability, only the “subclass of” -link from E2 Temporal Entity is shown. The latter comprises phenomena that continuously occur over some time-span (E52 Time-Span) in the natural time dimension, but some of them may not be confined to specific area, such as a marriage status. Further specializing, E4 Period comprises phenomena occurring in addition within a specific area in the physical space, which can be specified by *P7 took place at*, with range E53 Place. Instances of E4 Period can be of any size, such as the Warring States Period, the Roman Period, a siege or just the process of making a signature. Further specializing, E5 Event comprises phenomena involving and affecting certain instances of E77 Persistent Item in a way characteristic of the kind of process, which can be specified by the property *P12 occurred in the presence of*. This concept of presence is very powerful: It constrains the existence of the involved things to the respective places within the specified time and implies the potential of passive or active involvement and mutual impact. Via presence, events represent nodes in a network of things meeting in various combinations in the course of time at different places.

The most important specializations of E77 Persistent Item in this context are: E39 Actor, those capable of intentional actions, E18 Physical Thing, having an identity bound to a relative stability of material form, and E28 Conceptual Object, the idealized things that can be recognized but have an identity independent from the materialization on a specific carrier. The property *P12 occurred in the presence of* has 36 direct and indirect subproperties, relating these and many more subclasses of E5 Event and E77 Persistent Item. Regardless whether a CRM-compatible knowledge base is created with these properties only or with their much more expressive specializations, querying for the above presented five properties will provide answer to all “Who-When-Where-What-How” questions, and allow for retrieving potentially richly elaborated stories of people, places, times and things.

This pattern of “meeting” is complemented by two more subclasses of E5 Event: E63 Beginning of Existence and E64 End of Existence, which imply not only presence, but constitute the **endpoints of existence** of things and people in space and time, often in explicit presence and interaction with others, be they causal by producing or consuming or just witnessing. Note that the Model supports multiple instantiation. As a consequence, particular events can be instances of combinations of these and other classes, describing tightly integrated

processes of multiple nature. The representation of things connected in events by presence, beginning and end of existence is sufficient to describe the logic of *termini postquos and antequos*, a major form of reasoning about chronology in historical studies.

Example:

As a simple, real example of applying the above concepts we present a historical event, relevant for the history of art: Johann-Joachim Winkelmann (a German Scholar) has seen the so-called Laocoön Group in 1755 in the Vatican in Rome (at display in the Cortile del Belvedere). He described his impressions in 1764 in his “History of the Art of Antiquity”, (being the first to articulate the difference between Greek, Greco-Roman and Roman art, characterizing Greek art with the famous words “...noble simplicity, silent grandeur”). The sculpture, in Hellenistic “Pergamene baroque” style (Bieber 1961, Brilliant 2000) is widely assumed to be a copy, made between 27 BC and 68 AD (following a Roman commission) from a Greek (no more extant) original. Johann-Joachim Winkelmann was born 1717 as child of Martin Winkelmann and Anna-Maria Meyer and died in 1768 in Trieste.

Figure 2 presents a semantic graph of this event, as described above, using CIDOC CRM concepts. The facts in parentheses above are omitted for better clarity. Instances of classes are represented by informative labels instead of identifiers, in boxes showing the class label above the instance label. Properties are represented as arrows with the property label attached. After class labels and property labels, we show in parenthesis the identifiers of the respective superclasses and superproperties from figure 1, in order to demonstrate that the story can be represented and queried with these concepts only. It also shows how concept specialization increases expressiveness without losing genericity. It is noteworthy that the transfer of information from the Greek original, to the copy, to the mind of Winkelmann and into his writings can be solely understood by this chain of things *being present* in different meetings. Note also that the degree to which a fact is believed to be real does not affect the choice of CIDOC CRM concepts for description of the fact, nor the reality concept underlying the Model.

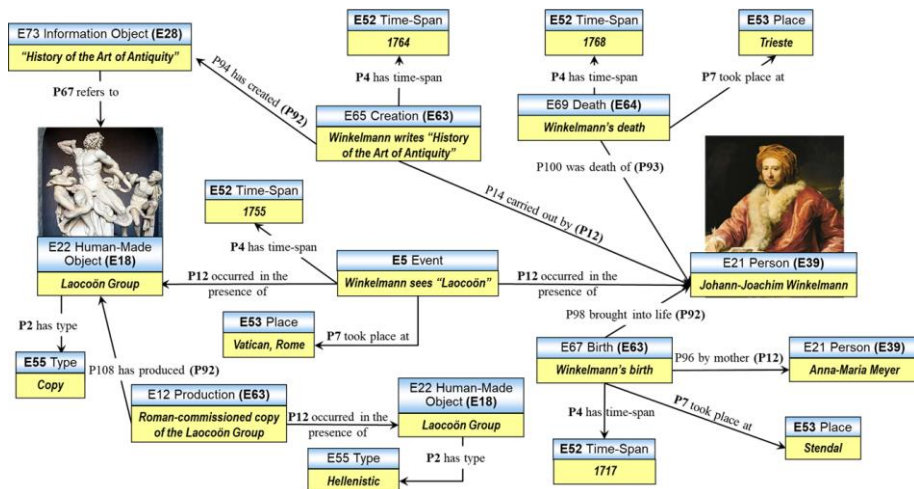

Figure 2: CIDOC CRM Encoding Example (Winkelmann seeing Laocoön)

Figure 2 represents in addition one more top-level property of the CIDOC CRM: *P67 refers to*, which describe an evidence-based fact that an information object makes reference to an identifiable item.

As mentioned above, the central concept of the CIDOC CRM is the representation of a part of reality that can be approximated as a network of things meeting in various combinations in spacetime. Using the same example from above, figure 3 illustrates this concept via an alternative symbolic representation. It aims at rendering the

idea that people and things in the past have performed mostly unknown trajectories in spacetime and the historical facts known to us constrain their possible whereabouts for some limited time-spans to having been together at some known or unknown place.

We use a one-dimensional representation of space, as used in archaeology to describe the spatial evolution of periods or cultures over time, and a vertical time axis. We symbolize the trajectories of things and people as fuzzy lines between events in order to render their relative indeterminacy between known events. Non-animate things use to be stationary if not transferred, whereas people may move around on their own. We symbolize events as fuzzy ovals to render the fuzzy boundaries of events in space and time. Note that in this representation, as a general pattern, things may “survive” events, emerge from events or end in events. Beginning and ending of existence impose an additional temporal order on events of causal nature, which can be stronger than explicit dates. We symbolize the unreported ends of existence of people and things, which are also events, by a dot at the end of the trajectory.

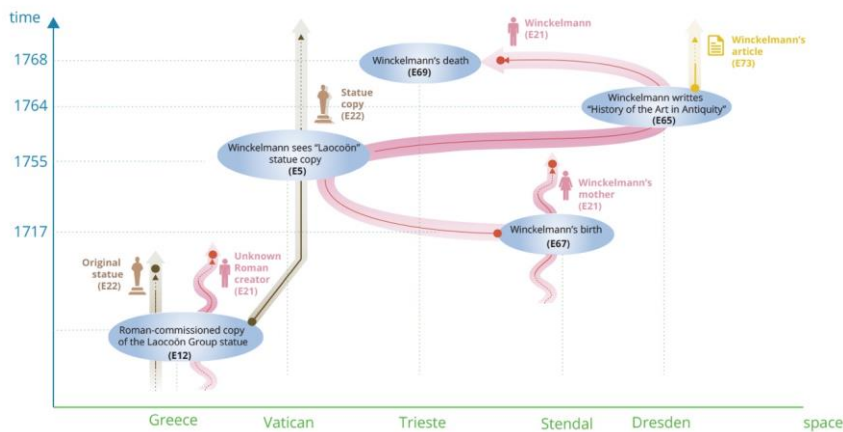

Figure 3: Symbolic Representation of "Winckelmann seeing Laocoön" as an Evolution in Space and Time

In the following, we give an overview of the system of spatial and temporal relations in the CIDOC CRM, because it constitutes an important tool for precise documentation of the past and has a certain complexity that needs to be understood in a synopsis.

Spatial Relations

A major area of documentation and historical research centres around positioning in space of what has happened and the things involved, as well as reasoning about respective spatial relations. The key class CIDOC CRM provides for modelling this information is E53 Place. E53 Place is used to document geometric extents in the physical space containing actual or possible positions of things or happenings. The higher-level properties and classes of CIDOC CRM that centre around E53 Place allow for the documentation of: relations between places; recording the geometric expressions defining or approximating a place and their semantic function; tracing the history of locations of a physical object; identifying the places where an individual or group have been located; identifying places on a physical object and the spatial extent of certain temporal entities.

Geometric Expressions of Place: Contemporary documentation of spatial information has access to advanced equipment for accurately recording location and libraries of georeferenced place information. For this reason, documentation of place now often includes the recording of precise coordinates for a referenced place. Of great importance semantically, is to understand the manner in which such a geometric place expression actually relates to a referenced place. The cluster or relations *P168 place is defined by*, *P171 at some place within*, and *P172*

contains allows the user to link to geometric place expressions while also accurately indicating how this expression relates to the documented place. Geometric place expressions are instances of E94 Space Primitive, a primitive class for expressing values in data systems not further analyzed-analysed in the CIDOC CRM. These properties provide a valid interface to the OGC standards, as elaborated in CRMgeo (Doerr & Hiebel 2013).

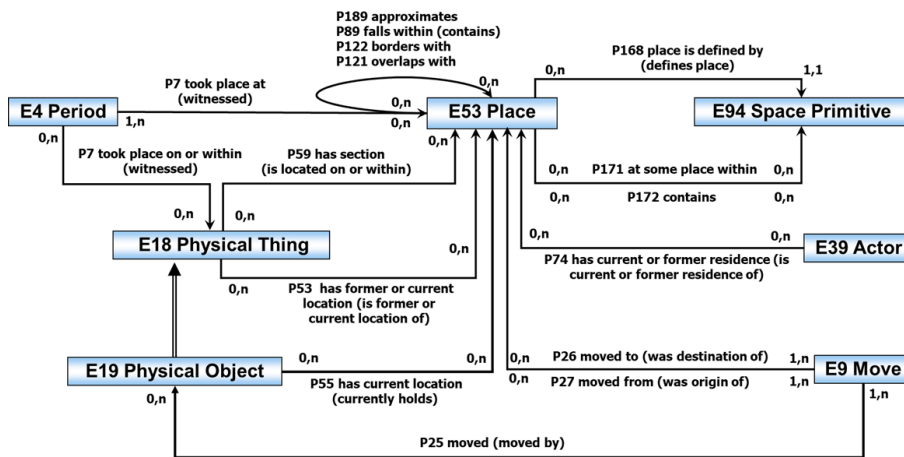

Figure 4: Basic CIDOC CRM Properties and Classes for Reasoning about Spatial Information

Relations between Places: The cluster of relations *P89 falls within (contains)*, *P122 borders with*, *P121 overlaps with* and *P189 approximates* can express relative relationships held between places. These properties hold between instances of E53 Place and allow interordering places using common mereotopological concepts.

History of Object Locations: Instances of place are often referenced in order to record the location of some object. When the movement of the object to different locations through time is of interest, it is also important to be able to analytically record the different locations at which an object was and at what point. The CIDOC CRM offers two top level mechanisms for tracing the relation of objects to places. If the aspect of time is unknown or not of interest, then an object can be related to a place through the properties *P53 has former or current location* and *P55 has current location*. The former property is the conservatively appropriate choice for documenting the object-to-place relation when time elements are not known. If one is actively tracking current location, the latter property is also of use. When an accurate history of the temporal aspect of location should be provided, the user should take advantage of the class E9 Move, a temporal entity class. Instantiating E9 Move allows the user to document the origin, destination and concerned object of a move event using the collection of properties *P27 moved from*, *P26 moved to*, *P25 moved*. Being a temporal class E9 Move further allows the tracing of time, agency etc. Note that things may be moved indirectly as parts of or within other things.

Actor Locations: Tracking the history of the location of actors is related to the history of object location with a significant difference: in the CIDOC CRM an actor is defined as an entity featuring agency which is not the case in objects and physical entities in general. Not being physical, an actor cannot be the subject of an instance of E9 Move which documents physical relocations. The CIDOC CRM thus offers the notion of *P74 has current or former residence* in order to document the relation of a person or group to a location as residing there at some time.

Places on a Physical Object: In the recording of cultural heritage and other scientific data, particularly about mobile objects, including ships, it is often necessary to identify where on an object or a certain feature is located and where a certain phenomenon is observed. For this the CIDOC CRM offers the relation *P59 has section* relating the object to the places which are defined upon it. Note that Earth is the physical object we relate places to per default. In geological times, a narrower relation to a tectonic plate may be necessary.

Spatial Extent of Temporal Entities: In order to spatially define the extent of temporal phenomena, the CIDOC CRM offers two properties that apply to all instances of temporal entity under the class E4 Period: *P7 took place at* and *P8 took place on or within*. The former is used to relate a temporal phenomenon directly to an instance of E53 Place which provides the geometric context in which that phenomenon took place. The latter property allows the documentation of a temporal phenomenon taking place in relation to a physical object. This is useful for recording information such as the occurrence of an event on a moving ship or within a particular storage container, where the geometric location is not known or indirectly relevant.

Temporal Relations

Historical and scientific discourse about the past deals with different levels of knowledge regarding events and their temporal ordering that feed into chronology. Chronology is fundamental to understanding social and natural history, and reasoning about temporal relations and causality is directly related. An immense wealth of physical observations allows for inferring temporal relations and vice-versa. It is important to be able to document temporality both with regards to known dates but also according to relative positioning within a historical time line. The top-level properties of the CIDOC CRM relating to temporal entities support the documentation of: dates as time spans or dimensions, mereological relations between temporal entities as well as a complete suite of topological relations.

Dates and Durations: When some absolute dates limiting a temporal entity are known, this can be documented by instantiating the *P4 has time-span* property and creating an instance of E52 Time-span. Dates should then be recorded as instances of E61 Time Primitive and related to the time-span through properties *P81 ongoing throughout* or *P82 at some time within*. Time is recorded as a span and not an instant in the CIDOC CRM. The choice of property *P81 ongoing throughout* allows the documentation of knowledge that a temporal phenomenon was occurring at least at all points of a known time span. The property *P82 at some time within* allows the weaker claim that the phenomenon must have occurred within the limits of a particular time span without further specifying as to when precisely. It is the default for historical dates, given, for instance, in years for events of much smaller duration. The actual mode of encoding the documented date is outside the scope of the CIDOC CRM, which defines this with a primitive class, E61 Time Primitive. Finally, the property *P191 had duration* can be deployed in order to document a temporal phenomenon with known duration but with less precisely temporal positioning. For instance, a birth may be known with the precision of a year, but with a duration of 3 hours. For documenting exact time-spans that are result of a declaration rather than observation, for instance in order to describe a time-span multiple events may fall into, the property *P170 defines time* allows for specifying the time-span uniquely by a temporal primitive, rather than by *P81 ongoing throughout* or *P82 at some time within* using an identical time primitive.

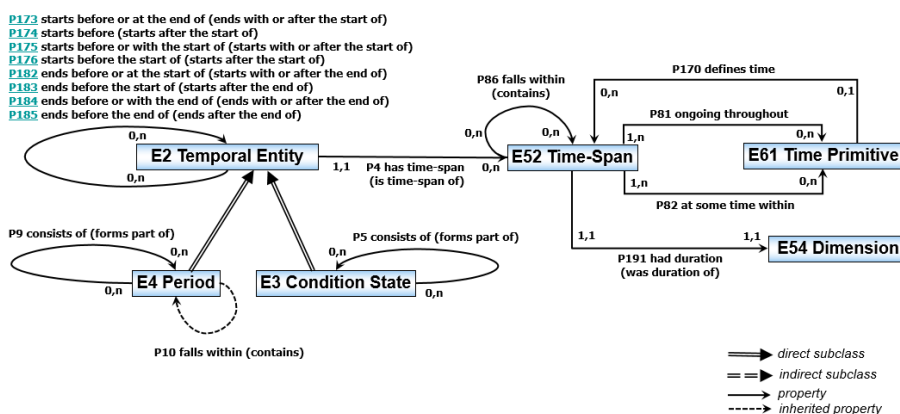

Figure 5: Basic CIDOC CRM Properties and Classes for Reasoning about Temporal Information

Mereological relations: The documentation of the part-whole relationship of temporal phenomena is crucial for historical reasoning. The CIDOC CRM distinguishes under temporal entities two immediate specializations: E4 Period is a high-level concept for the documentation of temporal phenomena of change and interactions in space and time, comprising but not limited to historical periods such as Ming or Roman, and is further specialized in rich hierarchy of more specific processes and activities. The second specialization is E3 Condition State, a rather specific class for the documentation of static phases of physical things. The CIDOC CRM so far does not describe a higher-level class of static phases, because they are normally deductions from multiple observations, problematic in information integration and vulnerable to non-monotonic revision. For both classes, two different mereological relations are articulated: The property *P9 consists of* is used to document proper parthood between instances of E4 Period, i.e., to describe how the phenomena that make up an instance of E4 Period can causally be subdivided into more delimited phenomena. In contrast, the property *P10 falls within*, explained further in the section about spatiotemporal relations, describes only a non-causal co-occurrence in the same spatiotemporal extent. The property *P5 consists of* indicates, in analogy, proper parthood between instances of E3 Condition State.

Topological Relations: A lot of semantic relations have implications on the temporal ordering of temporal entities. For instance, meeting someone must occur after birth and before death of the involved parties. Information can only be transferred after it has been learned. On the other side, direct information about temporal order has implications on possible or impossible semantic relations. This form of reasoning is of paramount importance for research about the past. It turned out that the popular temporal relations defined by (Allen, 1983), which the CIDOC CRM had adopted in previous versions, are not well suited to describe inferences from semantic relations, as detailed in the section “Temporal Relation Primitives based on fuzzy boundaries” below. Instead, the CIDOC CRM introduces a theory of fuzzy boundaries in time that enables the accurate interpositioning of temporal entities between themselves taking into account the inherent fuzziness of temporal boundaries. This model subsumes the earlier introduced Allen temporal relations which may continue to be used in extensions of the CIDOC CRM.

Spatiotemporal Relations

Treating space and time as separate entities is normally adequate for describing events and where things are. When more precise documentation and reasoning is required about phenomena spreading out over time, such as Bronze Age, a settlement, a nation, moving reference frames such as ships, things being stored in containers and moved around, built structures being partially destroyed, rebuilt and altered etc., space and time must be understood as a coherent continuum, the so-called spacetime. This is not a familiar concept for many users, and those not interested in such details may therefore skip this section.

However, the respective model the CIDOC CRM adopts constitutes a valid interface to the OGC standards, as elaborated in CRMgeo (Doerr & Hiebel 2013) and important for connecting to GIS applications. The key class CIDOC CRM provides for modelling this information is E92 Spacetime Volume. E92 Spacetime Volume is used to document geometric extents in the physical spacetime containing actual or possible positions of things or happenings, in particular in those cases when the changes of place to be documented cannot be reduced to distinct events, because the spatial extent changes continuously. The higher-level properties and classes of CIDOC CRM that centre around E92 Spacetime Volume allow for the documentation of: relations between spacetime volumes, relations to space and time as separate entities, and treating the exact extent of physical things and periods in space at any time of their existence as spacetime volumes. Its use is particularly elegant for the description of temporal gazetteers.

Defining a Spacetime Volume: There are three ways to define a spacetime volume:

- 1 the property *P169 defines spacetime volume* should be used to declare a spatiotemporal container for some things or happenings in terms of spatial coordinates that may vary over time, be it in discrete steps or continuously with the help of spacetime expressions. The latter are instances of E95 Spacetime

Primitive, a primitive class for expressing values in data systems not further analyzed-analysed in the CIDOC CRM.

- 2 Instances of E4 Period are regarded to be specialized instances of E92 Spacetime Volume that are formed by the spreading out of the phenomena that make up an instance of E4 Period. As such they are fuzzy but in general observable.
- 3 The continuous sequence of spatial extent that the matter of an instance of E18 Physical Thing occupies in the course of time, defines a spacetime volume unique to it from the beginning of its existence to its end, which can also be understood as its trajectory through the universe The property *P169 defines* allows for referring to this spacetime volume, in order to document its additional properties. As such this spacetime volume is fuzzy but in general observable. It is not easy to make a mental picture of the spacetime volume of a physical thing, but the construct simplifies all reasoning about where things have been.

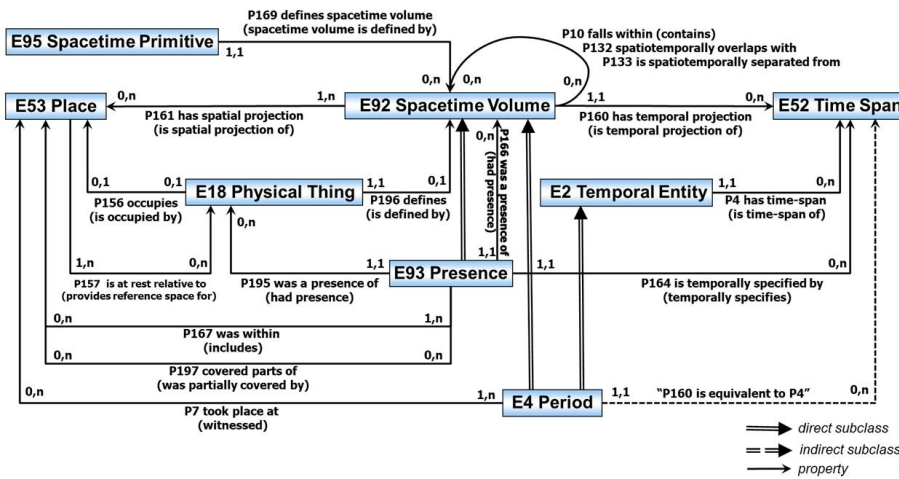

Figure 6: Basic CIDOC CRM Properties and Classes for Reasoning with Spacetime Volumes

Relations with Places and Physical Things: The property *P161 has spatial projection* associates a spacetime volume with the complete spatial extent it has occupied during its time-span of definition. Due to relativity of space, the definition of an instance of E53 Place must be relative to some physical thing as geometric reference. This can explicitly be documented with the property *P157 is at rest relative to*. If the place where something is at a certain point in time is given in multiple reference spaces in relative movement, such as with respect to a ship versus to the seafloor, these differently defined places may later move apart. Therefore, a spacetime volume, even though uniquely defined, can have any number of spatial projections, depending on the reference space. Currently, the GPS system defines a default reference space on the surface of Earth. In art conservation and other descriptions of mobile object of fixed shape, it is useful to refer to the precise place a physical thing occupies with respect to itself as reference space via *P156 occupies*, for further analysis. *P156 occupies* constitutes a particular projection of the spacetime volume of this thing. In contrast, the property *P53 has former or current location* only describes that a thing was within a specific place given in some reference space for an undefined time.

Relations with Time-Spans and Periods: The property *P160 has temporal projection* associates a spacetime volume with the complete temporal extent it has covered comprising all places of its definition. In contrast to

places, the reference system of time is unique⁸ except for the choice of origin. For instances of E4 Period and its subclasses, which inherit *P160 has temporal projection*, the property is actually identical with the property *P4 has time-span* inherited from E2 Temporal Entity, because it describes the temporal extent of the phenomena that make up an instance of E4 Period. Therefore, it is recommended to use *P4 has time-span* for instances of E4 Period and its subclasses, rather than *P160 has temporal projection*.

Relations of Presence: Instances of E93 Presence are specialized instances of E92 Spacetime Volume that are identical with the spatial evolution of a larger spacetime volume specified by *P166 was presence of*, but delimited to a, normally short, time-span declared by *P164 is temporally specified by*. In other words, they constitute “snapshots” or “time-slices” of another spacetime volume, such as the extent of the Roman Empire during 30AD. They are the basic construct to describe exactly where something was or happened at a particular time (-span), in connection with the property *P161 has spatial projection*. In particular, it allows for describing the whereabouts of mobile objects, be it in the storage of a museum, a palace, deposited in the ground, or transported in a container, such as the bone of a saint. For ease of use, a shortcut *P195 was presence of* is defined directly to E18 Physical Thing, bypassing the definition of its spacetime volume.

Topological Relations: Finally, the Model defines truly spatiotemporal topological relations. *P10 falls within (contains)* is the complete inclusion of one spacetime volume in another. It should not be confused with inclusion in the spatial and temporal projection, which may be larger. E.g., in 14 AD, Mesopotamia was not within the Roman Empire. Further, the properties *P132 spatiotemporally overlaps with* and its negation *P133 is spatiotemporally separated from* are fundamental to argue about temporary parthood, possible continuity etc.

Specific Modelling Constructs

About Types

Virtually all structured descriptions of museum objects begin with a unique object identifier and information about the “type” of the object, often in a set of fields with names like “Classification”, “Category”, “Object Type”, “Object Name”, etc. All these fields are used for terms that declare that the object belongs to a particular category of items. In the CIDOC CRM the class E55 Type comprises such terms from thesauri and controlled vocabularies used to characterize and classify instances of CIDOC CRM classes. Instances of E55 Type represent concepts (universals) in contrast to instances of E41 Appellation, which are used to name instances of CIDOC CRM classes.

For this purpose, the CIDOC CRM provides two basic properties that describe classification with terminology, corresponding to what is the current practice in the majority of information systems. The class E1 CRM Entity is the domain of the property *P2 has type (is type of)*, which has the range E55 Type. Consequently, every class in the CIDOC CRM, with the exception of E59 Primitive Value, inherits the property *P2 has type (is type of)*. This provides a general alternative mechanism to specialize the classification of CIDOC CRM instances to any level of detail, by linking to external vocabulary sources, thesauri, classification schemas or ontologies.

Analogous to the function of the *P2 has type (is type of)* property, some properties in the CIDOC CRM are associated with an additional property. These are numbered in the CIDOC CRM documentation with a ‘.1’ extension. The range of these properties of properties always falls under E55 Type. The purpose of a property of a property is to provide an alternative mechanism to specialize its domain property through the use of property subtypes declared as instances of E55 Type. They do not appear in the property hierarchy list but are included as part of the property declarations and referred to in the class declarations. For example, *P62.1 mode of depiction*: E55 Type is associated with E24 Physical Man-made Thing. *P62 depicts (is depicted by)*: E1 CRM Entity.

The class E55 Type also serves as the range of properties that relate to categorical knowledge commonly found in cultural documentation. For example, the property *P125 used object of type (was type of object used in)* enables the CIDOC CRM to express statements such as “this casting was produced using a mould”, meaning that

⁸ This holds for applications in the scope of the CIDOC CRM, which are in the non-relativistic area, but not strictly, for instance, for satellites.

there has been an unknown or unmentioned object, a mould, that was actually used. This enables the specific instance of the casting to be associated with the entire type of manufacturing devices known as moulds. Further, the objects of type “mould” would be related via *P2 has type (is type of)* to this term. This indirect relationship may actually help in detecting the unknown object in an integrated environment. On the other side, some casting may refer directly to a known mould via *P16 used specific object (was used for)*. So, a statistical question to how many objects in a certain collection are made with moulds could be answered correctly (following both paths through *P16 used specific object (was used for)* - *P2 has type (is type of)* and *P125 used object of type (was type of object used in)*). This consistent treatment of categorical knowledge enhances the CIDOC CRM’s ability to integrate cultural knowledge.

Types, that is, instances of E55 Type and its subclasses, can be used to characterize the instances of a CIDOC CRM class and hence refine the meaning of the class. A type ‘artist’ can be used to characterize persons through *P2 has type (is type of)*. On the other hand, in an art history application of the CIDOC CRM it can be adequate to extend the CIDOC CRM class E21 Person with a subclass E21.xx Artist. What is the difference of the type ‘artist’ and the class Artist? From an everyday conceptual point of view there is no difference. Both denote the concept ‘artist’ and identify the same set of persons. Thus, in this setting a type could be seen as a class and the class of types may be seen as a metaclass. Since current systems do not provide an adequate control of user defined metaclasses, the CIDOC CRM prefers to model instances of E55 Type as if they were particulars, with the relationships described in the previous paragraphs.

Users may decide to implement a concept either as a subclass extending the CIDOC CRM class system or as an instance of E55 Type. A new subclass should only be created in case the concept is sufficiently stable and associated with additional explicitly modelled properties specific to it. Otherwise, an instance of E55 Type provides more flexibility of use. Users that may want to describe a discourse not only using a concept extending the CIDOC CRM but also describing the history of this concept itself, may choose to model the same concept both as subclass and as an instance of E55 Type with the same name. Similarly, it should be regarded as good practice to foresee for each term hierarchy refining a CIDOC CRM class a term equivalent of this class as top term. For instance, a term hierarchy for instances of E21 Person may begin with “Person”.

One role of E55 Type is to be the CIDOC CRM’s interface to domain specific ontologies and thesauri or less formal terminological systems. Such sets of concepts can be represented in the CIDOC CRM as subclasses of E55 Type, forming hierarchies of terms, i.e., instances of E55 Type linked via *P127 has broader term (has narrower term)*. Such hierarchies may be extended with additional properties. Other standard models, in particular richer ones, used to describe terminological systems can also be interfaced with the CIDOC CRM by declaring their respective concept class as being equivalent to E55 Type, and their respective broader/narrower relation as being identical with *P127 has broader term (has narrower term)*, as long as they are semantically compatible.

In addition to being an interface to external thesauri and classification systems, E55 Type is an ordinary class in the CIDOC CRM and a subclass of E28 Conceptual Object. E55 Type and its subclasses inherit all properties from this superclass. Thus, together with the CIDOC CRM class E83 Type Creation the rigorous scholarly or scientific process that ensures a type is exhaustively described and appropriately named can be modelled inside the CIDOC CRM. In some cases, particularly in archaeology and the life sciences, E83 Type Creation requires the identification of an exemplary specimen and the publication of the type definition in an appropriate scholarly forum. This is very central to research in the life sciences, where a type would be referred to as a “taxon,” the type description as a “protologue,” and the exemplary specimens as “original element” or “holotype”.

Finally, instances of E55 Type or suitable subclasses can describe universals from type systems not organized in thesauri or ontologies, such as industrial product names and types, defined and published by the producers themselves for each new product or product variant.

Temporal Relation Primitives based on fuzzy boundaries

It is characteristic for sciences dealing with the past, such as history, archaeology or geology, to derive temporal topological relations from stratigraphic and other observations and from considerations of causality between

events. For this reason, the CIDOC CRM introduced in version 3.3 the whole set of temporal relationships of Allen's temporal logic (the now deprecated properties P114 to P120). It was regarded at that time as a well-justified, exhaustive and sufficient theory to deal with temporal topological relationships of spatiotemporal phenomena relevant to cultural historical discourse. Allen's temporal logic is based on the assumption of known, exact endpoints of time intervals (time-spans), described by an exhaustive set of mutually exclusive relationships.

Since many temporal relations can be inferred from facts causal to them, e.g., a birth necessarily occurring before any intentional interaction of a person with other individuals, or from observations of material evidence without knowing the absolute time, the temporal relationships pertain in the CIDOC CRM to E2 Temporal Entities, and not their Time-Spans, which require knowledge of absolute time. If absolute times are known, deduction of Allen's relation is a simple question of automated calculus and not the kind of primary scientific insight the CIDOC CRM, as a core model, is interested in. However, their application turned out to be problematic in practice for two reasons:

Firstly, facts causal to temporal relationships result in expressions that often require a disjunction (logical OR condition) of Allen's relationships. For instance, a child may be stillborn. Ignoring states at pregnancy as it is usual in older historical sources, birth may be *equal to* death, *meet* with death or be *before* death. The knowledge representation formalism chosen for the CIDOC CRM however does **not allow** for specifying **disjunctions**, except within queries. Consequently, simple properties of the CIDOC CRM that imply a temporal order, such as *P134 continued*, cannot be declared as subproperties of the temporal relationship they do imply, which would be, in this case: "before, meets, overlaps, starts, started-by, contains, finishes, finished-by, equals, during or overlapped by" (see *P174 starts before the end of*).

Secondly, nature does not allow us to observe equality of points in time. There are three possible interpretations to this fact. Common to all three interpretations is that they can be described in terms of fuzzy boundaries. The model proposed here is consistent with **all** three of these interpretations.

- 1 Any observable phenomenon that can be dated has a **natural temporal extent with fuzzy boundaries of gradual transition** from not existing to definitely existing and then to no longer existing.
- 2 These fuzzy boundaries can also be interpreted as the time intervals about which experts, even with a complete knowledge of the described phenomenon, may not agree as to whether this phenomenon is already ongoing or not, or still ongoing or not.
- 3 Under a third interpretation, the fact that an instance of E2 Temporal Entity is ongoing is **not observable** within the fuzzy boundaries.

Consider, for instance, a birth. Extending over a limited and non-negligible duration in the scale of hours it begins and ends gradually (1), but can be given alternative scientific definitions of start and end points (2), and neither of these can be determined with a precision much smaller than on a scale of minutes (3). The fuzzy boundaries **do not** describe the relation of incomplete or imprecise knowledge to reality. Assuming a lowest granularity in time is an approach which does not help, because the relevant extent of fuzziness varies at a huge scale even in cultural reasoning, depending on the type of phenomena considered. The only exact match is between arbitrarily declared time intervals, such as the end of a year being equal to the beginning of the next year, or that "Early Minoan" ends exactly when "Middle Minoan" starts, whenever that might have been. Consequently, we introduce here a new set of "temporal relation primitives" with the following characteristics:

- It is a minimal set of properties that allows for specifying all possible relations between two time intervals given by their start and end points, either directly, or by conjunction (logical AND condition) of the latter.
- Start and end points are interpreted as "thick" fuzzy boundaries as described above.
- Conditions of equality of end points are relaxed to the condition that the fuzzy boundaries **overlap**. Therefore, knowledge of the shape of the fuzzy function is **not** needed.
- All of Allen's relationships can be expressed either directly or by conjunctions of these properties.

- In case of time intervals without or with negligibly short fuzzy boundaries, all of Allen's relationships can exactly be described by adequate conjunctions of these properties.
- No relationship is equal to the inverse of another. Inverses are specified by exchanging the roles of domain and range.

Notation

We use the following notation:

Comparing two instances of E2 Temporal Entity, we denote one with capital letter A, its (fuzzy) starting time with A^{start} and its (fuzzy) ending time with A^{end} , such that $A = [A^{start}, A^{end}]$; we denote the other with capital letter B, its (fuzzy) starting time with B^{start} and its (fuzzy) ending time with B^{end} , such that $B = [B^{start}, B^{end}]$.

We identify a temporal relation with a predicate name (label) and define it by one or more (in)equality expressions between its end points, such as:

A starts before the end of B if and only if $(\Leftrightarrow) A^{start} < B^{end}$

We visualize a temporal relation symbolizing the temporal extents of two instances A and B of E2 Temporal Entity as horizontal bars, considered to be on a horizontal time-line proceeding from left to right. The fuzzy boundary areas are symbolized by an increasing/decreasing colour gradient. The different choices of relative arrangement the relationship allows for are symbolized by two extreme allowed positions of instance A with respect to instance B connected by arrows. The reader may imagine it as the relative positions of a train A approaching a station B. If the relative length of A compared to B matters, two diagrams are provided.

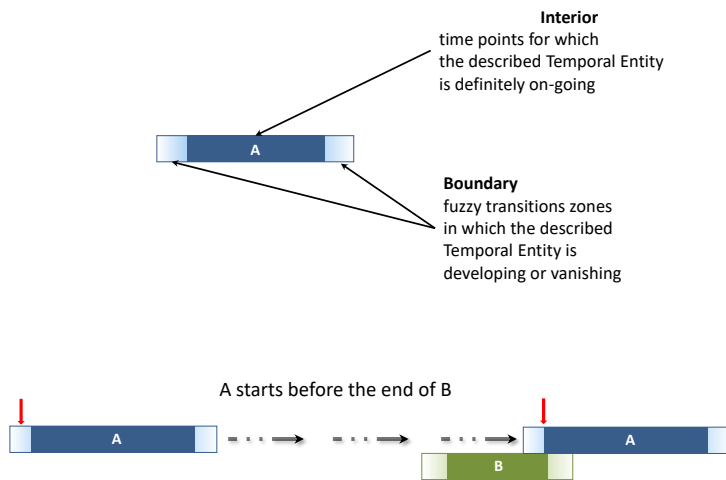

Figure 7: Explanation of Interior and Boundary and an Example of Use from P174 starts before the end of (ends after the start of).

Overview of Temporal Relation Primitives

The final set of temporal relation primitives can be separated into two groups:

- 1 Those based on improper inequalities, such as $A^{start} \leq B^{end}$ (odd number items in the list below- table 1).
- 2 Those based on proper inequalities, such as $A^{start} < B^{end}$ (even number items in the list below- table 1).

Improper inequalities with fuzzy boundaries are understood as extending into situations in which the fuzzy boundaries of the respective endpoints may overlap. In other words, they include situations in which it cannot be

decided when one interval has ended and when the other started, but there is no knowledge of a definite gap between these endpoints. In a proper inequality with fuzzy boundaries, the fuzzy boundaries of the respective endpoints must not overlap, i.e., there is knowledge of a definite gap between these endpoints, for instance, a discontinuity between settlement phases based on the observation of archaeological layers.

Table 2: Temporal Relation Primitives

	Property	Interpretation
1	P173 starts before or with the end of	$A^{\text{start}} \leq B^{\text{end}}$
2	P174 starts before the end of	$A^{\text{start}} < B^{\text{end}}$
3	P175 starts before or with the start of	$A^{\text{start}} \leq B^{\text{start}}$
4	P176 starts before the start of	$A^{\text{start}} < B^{\text{start}}$
5	P182 ends before or with the start of	$A^{\text{end}} \leq B^{\text{start}}$
6	P183 ends before the start of	$A^{\text{end}} < B^{\text{start}}$
7	P184 ends before or with the end of	$A^{\text{end}} \leq B^{\text{end}}$
8	P185 ends before the end of	$A^{\text{end}} < B^{\text{end}}$

Class & Property Hierarchies

Although they do not provide comprehensive definitions, compact mono-hierarchical presentations of the class and property IsA hierarchies have been found to significantly aid comprehension and navigation of the CIDOC CRM. Since the CRM is poly-hierarchical, a mono-hierarchical presentation form is achieved by a top-down expansion of all inverse IsA relations regardless whether a concept has already be presented at another place in the same hierarchy. This form is provided below.

The class hierarchy presented below has the following format:

- Each line begins with a unique class identifier, consisting of a number preceded by the letter “E” (originally denoting “entity,” although now replaced by convention with the term “class”).
- A series of hyphens (“-”) follows the unique class identifier, indicating the hierarchical position of the class in the IsA hierarchy.
- The English name of the class appears to the right of the hyphens.
- The index is ordered by hierarchical level, in a “depth first” manner, from the smaller to the larger subhierarchies.
- Classes that appear in more than one position in the class hierarchy as a result of multiple inheritance are shown in an italic typeface.

The property hierarchy presented below has the following format:

- Each line begins with a unique property identifier, consisting of a number preceded by the letter “P” (for “property”).
- A series of hyphens (“-”) follows the unique property identifier, indicating the hierarchical position of the property in the IsA hierarchy.
- The English name of the property appears to the right of the hyphens, followed by its inverse name in parentheses for reading in the range to domain direction.
- The domain class for which the property is declared.
- The range class that the property references.
- The index is ordered by hierarchical level, in a “depth first” manner, from the smaller to the larger subhierarchies, and by property number between equal siblings.
- Properties that appear in more than one position in the property hierarchy as a result of multiple inheritance are shown in an italic typeface.

CIDOC CRM Class Hierarchy

Table 3: CIDOC CRM Class Hierarchy

E1	CRM Entity
E2	- Temporal Entity
E3	- - Condition State
E4	- - Period
E5	- - - Event
E7	- - - - Activity
E8	- - - - - Acquisition
E96	- - - - - - Purchase
E9	- - - - - Move
E10	- - - - - Transfer of Custody
E11	- - - - - Modification
E12	- - - - - - Production
E79	- - - - - - Part Addition
E80	- - - - - - Part Removal
E13	- - - - - Attribute Assignment
E14	- - - - - - Condition Assessment
E15	- - - - - - Identifier Assignment
E16	- - - - - - Measurement
E17	- - - - - - Type Assignment
E65	- - - - - Creation
E83	- - - - - - Type Creation
E66	- - - - - Formation
E85	- - - - - Joining
E86	- - - - - Leaving
E87	- - - - - Curation Activity
E63	- - - - - Beginning of Existence
E67	- - - - - Birth
E81	- - - - - Transformation
E12	- - - - - <i>Production</i>
E65	- - - - - <i>Creation</i>
E83	- - - - - - <i>Type Creation</i>
E66	- - - - - <i>Formation</i>
E64	- - - - - End of Existence
E6	- - - - - Destruction
E68	- - - - - Dissolution
E69	- - - - - Death
E81	- - - - - <i>Transformation</i>
E77	- Persistent Item
E70	- - Thing
E72	- - - Legal Object
E18	- - - - Physical Thing
E19	- - - - - Physical Object
E20	- - - - - - Biological Object
E21	- - - - - - - Person
E22	- - - - - - Human-Made Object
E24	- - - - - - Physical Human-Made Thing
E22	- - - - - - <i>Human-Made Object</i>
E25	- - - - - - Human-Made Feature
E78	- - - - - - Curated Holding
E26	- - - - - - Physical Feature
E27	- - - - - - Site
E25	- - - - - - <i>Human-Made Feature</i>
E90	- - - - - Symbolic Object
E73	- - - - - Information Object

E29	-	-	-	-	-	Design or Procedure
E31	-	-	-	-	-	Document
E32	-	-	-	-	-	Authority Document
E33	-	-	-	-	-	Linguistic Object
E34	-	-	-	-	-	Inscription
E35	-	-	-	-	-	Title
E36	-	-	-	-	-	Visual Item
E37	-	-	-	-	-	Mark
E34	-	-	-	-	-	Inscription
E41	-	-	-	-	-	Appellation
E42	-	-	-	-	-	Identifier
E35	-	-	-	-	-	Title
E95	-	-	-	-	-	Spacetime Primitive
E94	-	-	-	-	-	Space Primitive
E61	-	-	-	-	-	Time Primitive
E71	-	-	-	-	-	Human-Made Thing
E24	-	-	-	-	-	Physical Human-Made Thing
E22	-	-	-	-	-	Human-Made Object
E25	-	-	-	-	-	Human-Made Feature
E78	-	-	-	-	-	Curated Holding
E28	-	-	-	-	-	Conceptual Object
E90	-	-	-	-	-	Symbolic Object
E73	-	-	-	-	-	Information Object
E29	-	-	-	-	-	Design or Procedure
E31	-	-	-	-	-	Document
E32	-	-	-	-	-	Authority Document
E33	-	-	-	-	-	Linguistic Object
E34	-	-	-	-	-	Inscription
E35	-	-	-	-	-	Title
E36	-	-	-	-	-	Visual Item
E37	-	-	-	-	-	Mark
E34	-	-	-	-	-	Inscription
E41	-	-	-	-	-	Appellation
E42	-	-	-	-	-	Identifier
E35	-	-	-	-	-	Title
E95	-	-	-	-	-	Spacetime Primitive
E94	-	-	-	-	-	Space Primitive
E61	-	-	-	-	-	Time Primitive
E89	-	-	-	-	-	Propositional Object
E73	-	-	-	-	-	Information Object
E29	-	-	-	-	-	Design or Procedure
E31	-	-	-	-	-	Document
E32	-	-	-	-	-	Authority Document
E33	-	-	-	-	-	Linguistic Object
E34	-	-	-	-	-	Inscription
E35	-	-	-	-	-	Title
E36	-	-	-	-	-	Visual Item
E37	-	-	-	-	-	Mark
E34	-	-	-	-	-	Inscription
E30	-	-	-	-	-	Right
E55	-	-	-	-	-	Type
E56	-	-	-	-	-	Language
E57	-	-	-	-	-	Material
E58	-	-	-	-	-	Measurement Unit
E98	-	-	-	-	-	Currency
E99	-	-	-	-	-	Product Type
E39	-	-	-	-	-	Actor
E74	-	-	-	-	-	Group
E21	-	-	-	-	-	Person
E52	-	-	-	-	-	Time-Span

E53 - Place
 E54 - Dimension
 E97 - - Monetary Amount
 E92 - Spacetime Volume
 E4 - - *Period*
 E5 - - - *Event*
 E7 - - - - *Activity*
 E8 - - - - - *Acquisition*
 E96 - - - - - *Purchase*
 E9 - - - - - *Move*
 E10 - - - - - *Transfer of Custody*
 E11 - - - - - *Modification*
 E12 - - - - - *Production*
 E79 - - - - - *Part Addition*
 E80 - - - - - *Part Removal*
 E13 - - - - - *Attribute Assignment*
 E14 - - - - - *Condition Assessment*
 E15 - - - - - *Identifier Assignment*
 E16 - - - - - *Measurement*
 E17 - - - - - *Type Assignment*
 E65 - - - - - *Creation*
 E83 - - - - - *Type Creation*
 E66 - - - - - *Formation*
 E85 - - - - - *Joining*
 E86 - - - - - *Leaving*
 E87 - - - - - *Curation Activity*
 E63 - - - - - *Beginning of Existence*
 E67 - - - - - *Birth*
 E81 - - - - - *Transformation*
 E12 - - - - - *Production*
 E65 - - - - - *Creation*
 E83 - - - - - *Type Creation*
 E66 - - - - - *Formation*
 E64 - - - - - *End of Existence*
 E6 - - - - - *Destruction*
 E68 - - - - - *Dissolution*
 E69 - - - - - *Death*
 E81 - - - - - *Transformation*
 E93 - - Presence
 E59 - Primitive Value
 E60 - - Number
 E61 - - *Time Primitive*
 E62 - - String
 E94 - - *Space Primitive*
 E95 - - *Spacetime Primitive*

CIDOC CRM Property Hierarchy

Table 4: CIDOC CRM Property Hierarchy

Property id	Property Name	Entity – Domain	Entity - Range
P1	is identified by (identifies)	E1 CRM Entity	E41 Appellation
P48	- has preferred identifier (is preferred identifier of)	E1 CRM Entity	E42 Identifier
P102	- has title (is title of)	E71 Human-Made Thing	E35 Title
P168i	- place is defined by (defines place)	E53 Place	E94 Space primitive
P169i	- spacetime volume is defined by (defines spacetime volume)	E92 Spacetime Volume	E95 Spacetime Primitive
P170i	- time is defined by (defines time)	E52 Time-Span	E61 Time Primitive
P2	has type (is type of)	E1 CRM Entity	E55 Type
P137	- exemplifies (is exemplified by)	E1 CRM Entity	E55 Type
P177	- assigned property type	E13 Attribute Assignment	E55 Type
P3	has note	E1 CRM Entity	E62 String
P79	- beginning is qualified by	E52 Time-Span	E62 String
P80	- end is qualified by	E52 Time-Span	E62 String
P190	- has symbolic content	E90 Symbolic Object	E62 String
P4	has time-span (is time-span of)	E2 Temporal Entity	E52 Time-Span
P5	consists of (forms part of)	E3 Condition State	E3 Condition State
P7	took place at (witnessed)	E4 Period	E53 Place
P8	took place on or within (witnessed)	E4 Period	E18 Physical Thing
P12	occurred in the presence of (was present at)	E5 Event	E77 Persistent Item
P111	- added (was added by)	E79 Part Addition	E18 Physical Thing
P113	- removed (was removed by)	E80 Part Removal	E18 Physical Thing
P11	- had participant (participated in)	E5 Event	E39 Actor
P14	- - carried out by (performed)	E7 Activity	E39 Actor
P22	- - - transferred title to (acquired title through)	E8 Acquisition	E39 Actor
P23	- - - transferred title from (surrendered title through)	E8 Acquisition	E39 Actor
P28	- - - custody surrendered by (surrendered custody through)	E10 Transfer of Custody	E39 Actor
P29	- - - custody received by (received custody through)	E10 Transfer of Custody	E39 Actor
P96	- - by mother (gave birth)	E67 Birth	E21 Person
P99	- - dissolved (was dissolved by)	E68 Dissolution	E74 Group
P143	- - joined (was joined by)	E85 Joining	E39 Actor
P144	- - joined with (gained member by)	E85 Joining	E74 Group
P145	- - separated (left by)	E86 Leaving	E39 Actor
P146	- - separated from (lost member by)	E86 Leaving	E74 Group
P151	- - was formed from (participated in)	E66 Formation	E74 Group
P16	- used specific object (was used for)	E7 Activity	E70 Thing
P33	- - used specific technique (was used by)	E7 Activity	E29 Design or Procedure
P111	- - added (was added by)	E79 Part Addition	E18 Physical Thing
P142	- - used constituent (was used in)	E15 Identifier Assignment	E90 Symbolic Object
P25	- moved (moved by)	E9 Move	E19 Physical Object
P31	- has modified (was modified by)	E11 Modification	E18 Physical Thing
P108	- - has produced (was produced by)	E12 Production	E24 Physical Human-Made Thing
P110	- - augmented (was augmented by)	E79 Part Addition	E18 Physical Thing E24 Physical Human-Made Thing
P112	- - diminished (was diminished by)	E80 Part Removal	E18 Physical Thing E24 Physical Human-Made Thing
P92	- brought into existence (was brought into existence by)	E63 Beginning of Existence	E77 Persistent Item
P94	- - has created (was created by)	E65 Creation	E28 Conceptual Object
P135	- - - created type (was created by)	E83 Type Creation	E55 Type

P95	- - has formed (was formed by)	E66 Formation	E74 Group
P98	- - brought into life (was born)	E67 Birth	E21 Person
P108	- - <i>has produced (was produced by)</i>	E12 Production	E24 Physical Human-Made Thing
P123	- - resulted in (resulted from)	E81 Transformation	E77 Persistent Item
P93	- took out of existence (was taken out of existence by)	E64 End of Existence	E77 Persistent Item
P13	- - destroyed (was destroyed by)	E6 Destruction	E18 Physical Thing
P99	- - <i>dissolved (was dissolved by)</i>	E68 Dissolution	E74 Group
P100	- - was death of (died in)	E69 Death	E21 Person
P124	- - transformed (was transformed by)	E81 Transformation	E77 Persistent Item
P15	was influenced by (influenced)	E7 Activity	E1 CRM Entity
P16	- <i>used specific object (was used for)</i>	E7 Activity	E70 Thing
P33	- - used specific technique (was used by)	E11 Modification	E29 Design or Procedure
P111	- - added (was added by)	E79 Part Addition	E18 Physical Thing
P142	- - used constituent (was used in)	E15 Identifier Assignment	E90 Symbolic Object
P17	- was motivated by (motivated)	E7 Activity	E1 CRM Entity
P134	- continued (was continued by)	E7 Activity	E7 Activity
P136	- was based on (supported type creation)	E83 Type Creation	E1 CRM Entity
P19	was intended use of (was made for)	E7 Activity	E71 Human-Made Thing
P20	had specific purpose (was purpose of)	E7 Activity	E5 Event
P21	had general purpose (was purpose of)	E7 Activity	E55 Type
P24	transferred title of (changed ownership through)	E8 Acquisition	E18 Physical Thing
P26	moved to (was destination of)	E9 Move	E53 Place
P27	moved from (was origin of)	E9 Move	E53 Place
P30	transferred custody of (custody transferred through)	E10 Transfer of Custody	E18 Physical Thing
P43	has dimension (is dimension of)	E70 Thing	E54 Dimension
P44	has condition (is condition of)	E18 Physical Thing	E3 Condition State
P45	consists of (is incorporated in)	E18 Physical Thing	E57 Material
P49	has former or current keeper (is former or current keeper of)	E18 Physical Thing	E39 Actor
P50	- has current keeper (is current keeper of)	E18 Physical Thing	E39 Actor
P109	- has current or former curator (is current or former curator of)	E78 Curated Holding	E39 Actor
P51	has former or current owner (is former or current owner of)	E18 Physical Thing	E39 Actor
P52	- has current owner (is current owner of)	E18 Physical Thing	E39 Actor
P53	has former or current location (is former or current location of)	E18 Physical Thing	E53 Place
P55	- has current location (currently holds)	E19 Physical Object	E53 Place
P156	- occupies (is occupied by)	E18 Physical Thing	E53 Place
P54	has current permanent location (is current permanent location of)	E19 Physical Object	E53 Place
P57	has number of parts	E19 Physical Object	E60 Number
P59	has section (is located on or within)	E18 Physical Thing	E53 Place
P62	depicts (is depicted by)	E24 Physical Human-Made Thing	E1 CRM Entity
P67	refers to (is referred to by)	E89 Propositional Object	E1 CRM Entity
P68	- foresees use of (use foreseen by)	E29 Design or Procedure	E57 Material
P70	- documents (is documented in)	E31 Document	E1 CRM Entity
P71	- lists (is listed in)	E32 Authority Document	E1 CRM Entity
P129	- is about (is subject of)	E89 Propositional Object	E1 CRM Entity
P138	- represents (has representation)	E36 Visual Item	E1 CRM Entity
P69	has association with (is associated with)	E29 Design or Procedure	E29 Design or Procedure
P72	has language (is language of)	E33 Linguistic Object	E56 Language
P74	has current or former residence (is current or former residence of)	E39 Actor	E53 Place
P75	possesses (is possessed by)	E39 Actor	E30 Right
P76	has contact point (provides access to)	E39 Actor	E41 Appellation
P81	ongoing throughout	E52 Time-Span	E61 Time Primitive
P82	at some time within	E52 Time-Span	E61 Time Primitive
P86	falls within (contains)	E52 Time-Span	E52 Time-Span
P89	falls within (contains)	E53 Place	E53 Place
P90	has value	E54 Dimension	E60 Number
P91	has unit (is unit of)	E54 Dimension	E58 Measurement Unit

P180	- has currency	E97 Monetary Amount	E98 Currency
P97	from father (was father for)	E67 Birth	E21 Person
P101	had as general use (was use of)	E70 Thing	E55 Type
P103	was intended for (was intention of)	E71 Human-Made Thing	E55 Type
P104	is subject to (applies to)	E72 Legal Object	E30 Right
P105	right held by (has right on)	E72 Legal Object	E39 Actor
P52	- <i>has current owner (is current owner of)</i>	E18 Physical Thing	E39 Actor
P106	is composed of (forms part of)	E90 Symbolic Object	E90 Symbolic Object
P165	- incorporates (is incorporated in)	E73 Information Object	E90 Symbolic Object
P107	has current or former member (is current or former member of)	E74 Group	E39 Actor
P121	overlaps with	E53 Place	E53 Place
P122	borders with	E53 Place	E53 Place
P125	used object of type (was type of object used in)	E7 Activity	E55 Type
P32	- used general technique (was technique of)	E7 Activity	E55 Type
P126	employed (was employed in)	E11 Modification	E57 Material
P127	has broader term (has narrower term)	E55 Type	E55 Type
P130	shows features of (features are also found on)	E70 Thing	E70 Thing
E731	- is translation of	E33 Linguistic Object	E33 Linguistic Object
P128	- carries (is carried by)	E18 Physical Thing	E90 Symbolic Object
P65	- - shows visual item (is shown by)	E24 Physical Human-Made Thing	E36 Visual Item
P132	spatiotemporally overlaps with	E92 Spacetime Volume	E92 Spacetime Volume
P10	- falls within (contains)	E92 Spacetime Volume	E92 Spacetime Volume
P91	— <i>forms part of</i>	E4 Period	E4 Period
P166	- - was a presence of (had presence)	E93 Presence	E92 Spacetime Volume
P46	is composed of (forms part of)	E18 Physical Thing	E18 Physical Thing
P56	- bears feature (is found on)	E19 Physical Object	E26 Physical Feature
P133	is separated from	E92 Spacetime Volume	E92 Spacetime Volume
P139	has alternative form (<i>is alternative form of</i>)	E41 Appellation	E41 Appellation
P140	assigned attribute to (was attributed by)	E13 Attribute Assignment	E1 CRM Entity
P34	- concerned (was assessed by)	E14 Condition Assessment	E18 Physical Thing
P39	- measured (was measured by)	E16 Measurement	E18 Physical Thing CRM Entity
P41	- classified (was classified by)	E17 Type Assignment	E1 CRM Entity
P141	assigned (was assigned by)	E13 Attribute Assignment	E1 CRM Entity
P35	- has identified (identified by)	E14 Condition Assessment	E3 Condition State
P37	- assigned (was assigned by)	E15 Identifier Assignment	E42 Identifier
P38	- deassigned (was deassigned by)	E15 Identifier Assignment	E42 Identifier
P40	- observed dimension (was observed in)	E16 Measurement	E54 Dimension
P42	- assigned (was assigned by)	E17 Type Assignment	E55 Type
P147	curated (was curated by)	E87 Curation Activity	E78 Curated Holding
P148	has component (is component of)	E89 Propositional Object	E89 Propositional Object
P150	defines typical parts of (defines typical wholes for)	E55 Type	E55 Type
P152	has parent (is parent of)	E21 Person	E21 Person
P157	is at rest relative to (provides reference space for)	E53 Place	E18 Physical Thing
P59i	- is located on or within	E53 Place	E18 Physical Thing
P156i	- <i>is occupied by</i>	E53 Place	E18 Physical Thing
P160	has temporal projection	E92 Spacetime Volume	E52 Time-Span
P164	- is temporally specified by (temporally specifies)	E93 Presence	E52 Time-Span
P161	has spatial projection	E92 Spacetime Volume	E53 Place
P167	was within (includes)	E93 Presence	E53 Place
P171	at some place within	E53 Place	E94 Space Primitive
P172	contains	E53 Place	E94 Space Primitive
P173	starts before or with the end of (ends after or with the start of)	E2 Temporal Entity	E2 Temporal Entity
P174	- starts before the end of (ends after the start of)	E2 Temporal Entity	E2 Temporal Entity
P184	- - ends before or with the end of (ends with or after the end of)	E2 Temporal Entity	E2 Temporal Entity

P185	- - - ends before the end of (ends after the end of)	E2 Temporal Entity	E2 Temporal Entity
P182	- - - ends before or <i>at-with</i> the start of (starts after or with the end of)	E2 Temporal Entity	E2 Temporal Entity
P175	- - starts before or with the start of (starts after or with the start of)	E2 Temporal Entity	E2 Temporal Entity
P176	- - - starts before the start of (starts after the start of)	E2 Temporal Entity	E2 Temporal Entity
P134i	- - - was <i>continued by</i>	E7 Activity	E7 Activity
P182	- - - ends before or <i>at-with</i> the start of (starts after or with the end of)	E2 Temporal Entity	E2 Temporal Entity
P183	- - - - ends before the start of (starts after the end of)	E2 Temporal Entity	E2 Temporal Entity
P179	had sales price (was sales price of)	E96 Purchase	E97 Monetary Amount
P186	produced thing of product type (is produced by)	E12 Production	E99 Product Type
P187	has production plan (is production plan for)	E99 Product Type	E29 Design or Procedure
P188	requires production tool (is production tool for)	E99 Product Type	E19 Physical Object
P189	approximates	E53 Place	E53 Place
P191	had duration (was duration of)	E52 Time-Span	E54 Dimension
P195	was a presence of (had presence)	E93 Presence	E18 Physical Thing
P196	defines (is defined by)	E18 Physical Thing	E92 Spacetime Volume
P197	covered parts of (was partially covered by)	E93 Presence	E53 Place
P198	holds or supports (is held or supported by)	E18 Physical Thing	E18 Physical Thing

This page is left blank on purpose

CIDOC CRM Class Declarations

The classes of the CIDOC CRM are comprehensively declared in this section using the following format:

- Class names are presented as headings in bold face, preceded by the class' unique identifier;
- The line "Subclass of:" declares the superclass of the class from which it inherits properties;
- The line "Superclass of:" is a cross-reference to the subclasses of this class;
- The line "Scope note:" contains the textual definition of the concept the class represents;
- The line "Examples:" contains a bulleted list of examples of instances of this class. If the example is also instance of a subclass of this class, the unique identifier of the subclass is added in parenthesis. If the example instantiates two classes, the unique identifiers of both classes is added in parenthesis. Non-fictitious examples may be followed by an explanation in brackets.
- The line "Properties:" declares the list of the class' properties;
- Each property is represented by its unique identifier, its forward and reverse names, and the range class that it links to, separated by colons;
- Inherited properties are not represented;
- Properties of properties are provided indented and in parentheses beneath their respective domain property.

E1 CRM Entity

Superclass of:

E2 Temporal Entity
E52 Time-Span
E53 Place
E54 Dimension
E59 Primitive Value
E77 Persistent Item
E92 Spacetime Volume

Scope note:

This class comprises all things in the universe of discourse of the CIDOC Conceptual Reference Model.

It is an abstract concept providing for three general properties:

- Identification by name or appellation, and in particular by a preferred identifier
- Classification by type, allowing further refinement of the specific subclass an instance belongs to
- Attachment of free text and other unstructured data for the expression of anything not captured by formal properties

All other classes within the CIDOC CRM are directly or indirectly specialisations of E1 CRM Entity.

Examples:

- the earthquake in Lisbon 1755 (E5) (Chester, 2001)

In First Order Logic:

E1(x)

Properties:

P1 is identified by (identifies): E41 Appellation

P2 has type (is type of): E55 Type

P3 has note: E62 String

(P3.1 has type: E55 Type)

P48 has preferred identifier (is preferred identifier of): E42 Identifier

P137 exemplifies (is exemplified by): E55 Type

(P137.1 in the taxonomic role: E55 Type)

E2 Temporal Entity

Subclass of:

E1 CRM Entity

Superclass of:

E3 Condition State

E4 Period

Scope note:

This class comprises all phenomena, such as the instances of E4 Periods and E5 Events, which happen over a limited extent in time. This extent in time must be contiguous, i.e., without gaps. In case the defining kinds of phenomena for an instance of E2 Temporal Entity cease to

happen, and occur later again at another time, we regard that the former instance of E2 Temporal Entity has ended and a new instance has come into existence. In more intuitive terms, the same event cannot happen twice.

In some contexts, such phenomena are also called perdurants. This class is disjoint from E77 Persistent Item and is an abstract class that typically has no direct instances. E2 Temporal Entity is specialized into E4 Period, which applies to a particular geographic area (defined with a greater or lesser degree of precision), and E3 Condition State, which applies to instances of E18 Physical Thing.

Examples:

- Bronze Age (E4) (Childe, 1963)
- the earthquake in Lisbon 1755 (E5) (Chester, 2001)
- the Peterhof Palace near Saint Petersburg being in ruins from 1944 – 1946 (E3) (Maddox, 2015)

In First Order Logic:

$E2(x) \Rightarrow E1(x)$

Properties:

P4 has time-span (is time-span of): E52 Time-Span
P173 starts before or with the end of (ends after or with the start of): E2 Temporal Entity
P174 starts before the end of (ends after the start of): E2 Temporal Entity
P175 starts before or with the start of (starts after or with the start of): E2 Temporal Entity
P176 starts before the start of (starts after the start of): E2 Temporal Entity
P182 ends before or with the start of (starts after or with the end of): E2 Temporal Entity
P183 ends before the start of (starts after the end of): E2 Temporal Entity
P184 ends before or with the end of (ends with or after the end of): E2 Temporal Entity
P185 ends before the end of (ends after the end of): E2 Temporal Entity

E3 Condition State

Subclass of:

E2 Temporal Entity

Scope note:

This class comprises the states of objects characterised by a certain condition over a time-span.

An instance of this class describes the prevailing physical condition of any material object or feature during a specific instance of E52 Time-Span. In general, the time-span for which a certain condition can be asserted may be shorter than the real time-span, for which this condition held.

The nature of that condition can be described using *P2 has type*. For example, the instance of E3 Condition State “condition of the SS Great Britain between 22 September 1846 and 27 August 1847” can be characterized as an instance “wrecked” of E55 Type.

Examples:

- the "reconstructed" state of the “Amber Room” in Tsarskoje Selo from summer 2003 until now (Owen, 2009)
- the "ruined" state of Peterhof Palace near Saint Petersburg from 1944 to 1946 (Maddox, 2015)
- the state of my turkey in the oven at 14:30 on 25 December, 2002 [*P2 has type: E55 Type* “still not cooked”] (fictitious)

- the topography of the leaves of Sinai Printed Book 3234.2361 on the 10th of July 2007 [described as: of type "cockled"] (fictitious)

In First Order Logic:

$E3(x) \Rightarrow E2(x)$

Properties:

P5 consists of (forms part of): E3 Condition State

E4 Period

Subclass of:

E2 Temporal Entity

E92 Spacetime Volume

Superclass of:

E5 Event

Scope note:

This class comprises sets of coherent phenomena or cultural manifestations occurring in time and space.

It is the social or physical coherence of these phenomena that identify an instance of E4 Period and not the associated spatiotemporal extent. This extent is only the “ground” or space in an abstract physical sense that the actual process of growth, spread and retreat has covered.

Consequently, different periods can overlap and coexist in time and space, such as when a nomadic culture exists in the same area and time as a sedentary culture. This also means that overlapping land use rights, common among first nations, amounts to overlapping periods.

Often, this class is used to describe prehistoric or historic periods such as the “Neolithic Period”, the “Ming Dynasty” or the “McCarthy Era”, but also geopolitical units and activities of settlements are regarded as special cases of E4 Period. However, there are no assumptions about the scale of the associated phenomena. In particular all events are seen as synthetic processes consisting of coherent phenomena. Therefore, E4 Period is a superclass of E5 Event. For example, a modern clinical birth, an instance of E67 Birth, can be seen as both a single event, i.e., an instance of E5 Event, and as an extended period, i.e., an instance of E4 Period, that consists of multiple physical processes and complementary activities performed by multiple instances of E39 Actor.

As the actual extent of an instance of E4 Period in spacetime we regard the trajectories of the participating physical things during their participation in an instance of E4 Period. This includes the open spaces via which these things have interacted and the spaces by which they had the potential to interact during that period or event in the way defined by the type of the respective period or event. Examples include the air in a meeting room transferring the voices of the participants. Since these phenomena are fuzzy, we assume the spatiotemporal extent to be contiguous, except for cases of phenomena spreading out over islands or other separated areas, including geopolitical units distributed over disconnected areas such as islands or colonies.

Whether the trajectories necessary for participants to travel between these areas are regarded as part of the spatiotemporal extent or not has to be decided in each case based on a concrete analysis, taking use of the sea for other purposes than travel, such as fishing, into consideration. One may also argue that the activities to govern disconnected areas imply travelling through spaces connecting them and that these areas hence are spatially connected in

a way, but it appears counterintuitive to consider for instance travel routes in international waters as extensions of geopolitical units.

Consequently, an instance of E4 Period may occupy a number of disjoint spacetime volumes, however there must not be a discontinuity in the timespan covered by these spacetime volumes. This means that an instance of E4 Period must be contiguous in time. If it has ended in all areas, it has ended as a whole. However, it may end in one area before another, such as in the Polynesian migration, and it continues as long as it is ongoing in at least one area.

We model E4 Period as a subclass of E2 Temporal Entity and of E92 Spacetime Volume. The latter is intended as a phenomenal spacetime volume as defined in CIDOC CRMgeo (Doerr & Hiebel, 2013). By virtue of this multiple inheritance, we can discuss the physical extent of an instance of E4 Period without representing each instance of it together with an instance of its associated spacetime volume. This model combines two quite different kinds of substance: an instance of E4 Period is a phenomenon while an instance of E92 Spacetime Volume is an aggregation of points in spacetime. However, the real spatiotemporal extent of an instance of E4 Period is regarded to be unique to it due to all its details and fuzziness; its identity and existence depends uniquely on the identity of the instance of E4 Period. Therefore, this multiple inheritance is unambiguous and effective and furthermore corresponds to the intuitions of natural language.

Typical use of this class in cultural heritage documentation is for documenting cultural and artistic periods. There are two different conceptualisations of 'artistic style', defined either by physical features or by historical context. For example, "Impressionism" can be viewed as a period in the European sphere of influence lasting from approximately 1870 to 1905 during which paintings with particular characteristics were produced by a group of artists that included (among others) Monet, Renoir, Pissarro, Sisley and Degas. Alternatively, it can be regarded as a style applicable to all paintings sharing the characteristics of the works produced by the Impressionist painters, regardless of historical context. The first interpretation is an instance of E4 Period, and the second defines morphological object types that fall under E55 Type.

A geopolitical unit as a specific case of an instance of E4 Period is the set of activities and phenomena related to the claim of power, the consequences of belonging to a jurisdictional area and an administrative system that establishes a geopolitical unit. Examples from the modern period are countries or administrative areas of countries such as districts whose actions and structures define activities and phenomena in the area that they intend to govern. The borders of geopolitical units are often defined in contracts or treaties although they may deviate from the actual practice. The spatiotemporal properties of Geopolitical units can be modelled through the properties inherited from E92 Spacetime Volume.

Another specific case of an instance of E4 Period is the actual extent of the set of activities and phenomena as evidenced by their physical traces that define a settlement, such as the populated period of Nineveh.

Examples:

- Jurassic (Hallam, 1975)
- Populated Period of Nineveh
- Imperial Rome under Marcus Aurelius
- European Bronze Age (Harrison, 2004)
- Italian Renaissance (Macdonald, 1992)
- Thirty Years War (Lee, 1991)
- Sturm und Drang (Berkoff, 2013)
- Cubism (Cox, 2000)

In First Order Logic:

$E4(x) \Rightarrow E2(x)$

$E4(x) \Rightarrow E92(x)$

Properties:

$P7$ took place at (witnessed): $E53$ Place

$P8$ took place on or within (witnessed): $E18$ Physical Thing

$P9$ consists of (forms part of): $E4$ Period

E5 Event

Subclass of:

$E4$ Period

Superclass of:

$E7$ Activity

$E63$ Beginning of Existence

$E64$ End of Existence

Scope note:

This class comprises distinct, delimited and coherent processes and interactions of a material nature, in cultural, social or physical systems, involving and affecting instances of $E77$ Persistent Item in a way characteristic of the kind of process. Typical examples are meetings, births, deaths, actions of decision taking, making or inventing things, but also more complex and extended ones such as conferences, elections, building of a castle, or battles.

While the continuous growth of a tree lacks the limits characteristic of an event, its germination from a seed does qualify as an event. Similarly, the blowing of the wind lacks the distinctness and limits of an event, but a hurricane, flood or earthquake would qualify as an event. Mental processes are considered as events, in cases where they are connected with the material externalization of their results; for example, the creation of a poem, a performance or a change of intention that becomes obvious from subsequent actions or declarations.

The effects of an instance of $E5$ Event may not lead to relevant permanent changes of properties or relations of the items involved in it, for example an unrecorded performance. Of course, in order to be documented, some kind of evidence for an event must exist, be it witnesses, traces or products of the event.

While instances of $E4$ Period always require some form of coherence between its constituent phenomena, in addition, the essential constituents of instances of $E5$ Event should contribute to an overall effect; for example, the statements made during a meeting and the listening of the audience.

Viewed at a coarse level of detail, an instance of $E5$ Event may appear as if it had an 'instantaneous' overall effect, but any process or interaction of material nature in reality have an extent in time and space. At a fine level, instances of $E5$ Event may be ~~analyzed~~analysed into component phenomena and phases within a space and timeframe, and as such can be seen as a period, regardless of the size of the phenomena. The reverse is not necessarily the case: not all instances of $E4$ Period give rise to a noteworthy overall effect and are thus not instances of $E5$ Event.

Examples:

- the birth of Cleopatra ($E67$) (Pomeroy, 1984)
- the destruction of Herculaneum by volcanic eruption in 79 AD ($E6$) (Camardo, 2013)

- World War II (E7) (Barber, 1994)
- the Battle of Stalingrad (E7) (Hoyt, 1993)
- the Yalta Conference (E7) (Harbutt, 2010)
- my birthday celebration 28-6-1995 (E7)
- the falling of a tile from my roof last Sunday (fictitious)
- the CIDOC conference 2003 (E7)

In First Order Logic:

$E5(x) \Rightarrow E4(x)$

Properties:

P11 had participant (participated in): E39 Actor

P12 occurred in the presence of (was present at): E77 Persistent Item

E6 Destruction

Subclass of:

E64 End of Existence

Scope note:

This class comprises events that destroy one or more instances of E18 Physical Thing such that they lose their identity as the subjects of documentation.

Some destruction events are intentional, while others are independent of human activity. Intentional destruction may be documented by classifying the event as both an instance of E6 Destruction and of E7 Activity.

The decision to document an object as destroyed, transformed or modified is context sensitive:

1. If the matter remaining from the destruction is not documented, the event is modelled solely as an instance of E6 Destruction.
2. An event should also be documented as an instance of E81 Transformation if it results in the destruction of one or more objects and the simultaneous production of others using parts or material from the original. In this case, the new items have separate identities. Matter is preserved, but identity is not.
3. When the initial identity of the changed instance of E18 Physical Thing is preserved, the event should be documented as an instance of E11 Modification.

Examples:

- the destruction of Herculaneum by volcanic eruption in 79 AD (Camardo, 2013)
- the destruction of Nineveh (E6, E7) (River, 2016)
- the breaking of a champagne glass yesterday by my dog (fictitious)

In First Order Logic:

$E6(x) \Rightarrow E64(x)$

Properties:

P13 destroyed (was destroyed by): E18 Physical Thing

E7 Activity

Subclass of:

E5 Event

Superclass of:

E8 Acquisition
E9 Move
E10 Transfer of Custody
E11 Modification
E13 Attribute Assignment
E65 Creation
E66 Formation
E85 Joining
E86 Leaving
E87 Curation Activity

Scope note:

This class comprises actions intentionally carried out by instances of E39 Actor that result in changes of state in the cultural, social, or physical systems documented.

This notion includes complex, composite and long-lasting actions such as the building of a settlement or a war, as well as simple, short-lived actions such as the opening of a door.

Examples:

- the Battle of Stalingrad (Hoyt, 1993)
- the Yalta Conference (Harbutt, 2010)
- my birthday celebration 28-6-1995
- the writing of “Faust” by Goethe (E65) (Williams, 2020)
- the formation of the Bauhaus 1919 (E66) (Droste, 2006)
- calling the place identified by TGN ‘7017998’ ‘Quyunjig’ by the people of Iraq
- Kira Weber working in glass art from 1984 to 1993
- Kira Weber working in oil and pastel painting from 1993

In First Order Logic:

$E7(x) \Rightarrow E5(x)$

Properties:

P14 carried out by (performed): E39 Actor
(P14.1 in the role of: E55 Type)
P15 was influenced by (influenced): E1 CRM Entity
P16 used specific object (was used for): E70 Thing
(P16.1 mode of use: E55 Type)
P17 was motivated by (motivated): E1 CRM Entity
P19 was intended use of (was made for): E71 Human-Made Thing
(P19.1 mode of use: E55 Type)
P20 had specific purpose (was purpose of): E5 Event
P21 had general purpose (was purpose of): E55 Type
P32 used general technique (was technique of): E55 Type
P33 used specific technique (was used by): E29 Design or Procedure
P125 used object of type (was type of object used in): E55 Type
P134 continued (was continued by): E7 Activity

E8 Acquisition

Subclass of:

E7 Activity

Superclass of:

E96 Purchase

Scope note:

This class comprises transfers of legal ownership from one or more instances of E39 Actor to one or more other instances of E39 Actor.

The class also applies to the establishment or loss of ownership of instances of E18 Physical Thing. It does not, however, imply changes of any other kinds of right. The recording of the donor and/or recipient is optional. It is possible that in an instance of E8 Acquisition there is either no donor or no recipient. Depending on the circumstances, it may describe:

- 1 the beginning of ownership
- 2 the end of ownership
- 3 the transfer of ownership
- 4 the acquisition from an unknown source
- 5 the loss of title due to destruction of the item

It may also describe events where a collector appropriates legal title, for example by annexation or field collection. The interpretation of the museum notion of "accession" differs between institutions. The CIDOC CRM therefore models legal ownership (E8 Acquisition) and physical custody (E10 Transfer of Custody) separately. Institutions will then model their specific notions of accession and deaccession as combinations of these.

Examples

- the collection of a hammer-head shark of the genus *Sphyrna* Rafinesque, 1810 (Carchariniformes) by John Steinbeck and Edward Ricketts at Puerto Escondido in the Gulf of Mexico on March 25th, 1940. (Steinbeck, 2000)
- the acquisition of El Greco's painting entitled 'The Apostles Peter and Paul' by the State Hermitage in Saint Petersburg. (<https://hermitagemuseum.org/wps/portal/hermitage/digital-collection/01.+Paintings/32730>)
- the loss of my stuffed chaffinch '*Fringilla coelebs* Linnaeus, 1758' due to insect damage last year (fictitious)

In First Order Logic:

$E8(x) \Rightarrow E7(x)$

Properties:

P22 transferred title to (acquired title through): E39 Actor

P23 transferred title from (surrendered title through): E39 Actor

P24 transferred title of (changed ownership through): E18 Physical Thing

E9 Move

Subclass of:

E7 Activity

Scope note:

This class comprises changes of the physical location of the instances of E19 Physical Object.

Note, that the class E9 Move inherits the property *P7 took place at (witnessed)*: E53 Place. This property should be used to describe the trajectory or a larger area within which a move takes place, whereas the properties *P26 moved to (was destination of)*, *P27 moved from (was origin of)* describe the start and end points only. Moves may also be documented to consist of other moves (via *P9 consists of (forms part of)*), in order to describe intermediate stages on a trajectory. In that case, start and end points of the partial moves should match appropriately between each other and with the overall event.

Examples:

- the relocation of London Bridge from the UK to the USA- (Wildfang, 2005)
- the movement of the exhibition “Tutankhamun: Treasures of the Golden Pharaoh” between 15th September and 2nd November 2019

In First Order Logic:

$E9(x) \Rightarrow E7(x)$

Properties:

P25 moved (moved by): E19 Physical Object
P26 moved to (was destination of): E53 Place
P27 moved from (was origin of): E53 Place

E10 Transfer of Custody

Subclass of:

E7 Activity

Scope note:

This class comprises transfers of the physical custody or the legal responsibility for the physical custody of objects. The recording of the donor or recipient is optional. It is possible that in an instance of E10 Transfer of Custody there is either no donor or no recipient.

Depending on the circumstances, it may describe:

- 1 the beginning of custody (there is no previous custodian)
- 2 the end of custody (there is no subsequent custodian)
- 3 the transfer of custody (transfer from one custodian to the next)
- 4 the receipt of custody from an unknown source (the previous custodian is unknown)
- 5 the declared loss of an object (the current or subsequent custodian is unknown)

In the event that only a single kind of transfer of custody occurs, either the legal responsibility for the custody or the actual physical possession of the object but not both, this difference should be expressed using the property P2 has type (is type of).

The sense of physical possession requires that the object of custody be in the hands of the keeper at least with a part representative for the whole. The way, in which a representative part is defined, should ensure that it is unambiguous who keeps a part and who the whole and should be consistent with the identity criteria of the kept instance of E18 Physical Thing.

The interpretation of the museum notion of "accession" differs between institutions. The CIDOC CRM therefore models legal ownership and physical custody separately. Institutions will then model their specific notions of accession and deaccession as combinations of these.

Theft is a specific case of illegal transfer of custody.

Examples:

- the delivery of the paintings by Secure Deliveries Inc. to the National Gallery
- the return of Picasso's "Guernica" to Madrid's Prado in 1981 (Chipp, 1988)
- the transfer of custody of the work described as "Von der Velden ein Ufer an der See" from Johann Matthäus von Merian to the Auction House Heldevier (Jacob) for the purpose of sale, ca. 1716
- the transfer of custody of the painting 'Mrs. Fitzherbert' to the art dealer Knoedler from Parke-Bernet Galleries (New York, NY, USA) ca. March 1941

In First Order Logic:

$E10(x) \Rightarrow E7(x)$

Properties:

P28 custody surrendered by (surrendered custody through): E39 Actor
P29 custody received by (received custody through): E39 Actor
P30 transferred custody of (custody transferred through): E18 Physical Thing

E11 Modification

Subclass of:

E7 Activity

Superclass of:

E12 Production
E79 Part Addition
E80 Part Removal

Scope note:

This class comprises instances of E7 Activity that are undertaken to create, alter or change instances of E24 Physical Human-Made Thing.

This class includes the production of an item from raw materials and other so far undocumented objects. It also includes the conservation treatment of an object.

Since the distinction between modification and production is not always clear, modification is regarded as the more generally applicable concept. This implies that some items may be consumed or destroyed in an instance of E11 Modification, and that others may be produced as a result of it. An event should also be documented using an instance of E81 Transformation if it results in the destruction of one or more objects and the simultaneous production of others using parts or material from the originals. In this case, the new items have separate identities.

An activity undertaken on an object which was designed to alter it, but which, in fact, it did not in any seemingly significant way (such as the application of a solvent during conservation which failed to dissolve any part of the object), is still considered as an instance of E11

Modification. Typically, any such activity will leave at least forensic traces of evidence on the object.

If the instance of E29 Design or Procedure utilized for the modification prescribes the use of specific materials, they should be documented using property *P68 foresees use of (use foreseen by)*: E57 Material of E29 Design or Procedure, rather than via *P126 employed (was employed in)*: E57 Material.

Examples:

- the construction of the SS Great Britain (E12) (Gregor, 1971)
- the impregnation of the Vasa warship in Stockholm for preservation after 1956 (Håfors, 2010)
- the transformation of the Enola Gay into a museum exhibit by the National Air and Space Museum in Washington DC between 1993 and 1995 (E12, E81) (Yakel, 2000)
- the last renewal of the gold coating of the Toshogu shrine in Nikko, Japan (Cali and Dougil, 2012)

In First Order Logic:

$E11(x) \Rightarrow E7(x)$

Properties:

P31 has modified (was modified by): E18 Physical Thing
P126 employed (was employed in): E57 Material

E12 Production

Subclass of:

E11 Modification
E63 Beginning of Existence

Scope note:

This class comprises activities that are designed to, and succeed in, creating one or more new items.

It specializes the notion of modification into production. The decision as to whether or not an object is regarded as new is context sensitive. Normally, items are considered “new” if there is no obvious overall similarity between them and the consumed items and material used in their production. In other cases, an item is considered “new” because it becomes relevant to documentation by a modification. For example, the scribbling of a name on a potsherd may make it a voting token. The original potsherd may not be worth documenting, in contrast to the inscribed one.

This entity can be collective: the printing of a thousand books, for example, would normally be considered a single event.

An event should also be documented using an instance of E81 Transformation if it results in the destruction of one or more objects and the simultaneous production of others using parts or material from the originals. In this case, the new items have separate identities and matter is preserved, but identity is not.

Examples:

- the construction of the SS Great Britain (Gregor, 1971)
- the first casting of the Little Mermaid from the harbour of Copenhagen (Dewey, 2003)
- Rembrandt’s creating of the seventh state of his etching “Woman sitting half dressed beside a stove”, 1658, identified by Bartsch Number 197 (E12, E65, E81) (Hind, 1923)

In First Order Logic:

$E12(x) \Rightarrow E11(x)$

$E12(x) \Rightarrow E63(x)$

Properties:

P108 has produced (was produced by): E24 Physical Human-Made Thing

P186 produced thing of product type (is produced by): E99 Product Type

E13 Attribute Assignment

Subclass of:

E7 Activity

Superclass of:

E14 Condition Assessment

E15 Identifier Assignment

E16 Measurement

E17 Type Assignment

Scope note:

This class comprises the actions of making assertions about one property of an object or any single relation between two items or concepts. The type of the property asserted to hold between two items or concepts can be described by the property *P177 assigned property type*: E55 Type.

For example, the class describes the actions of people making propositions and statements during certain scientific/scholarly procedures, e.g., the person and date when a condition statement was made, an identifier was assigned, the museum object was measured, etc. Which kinds of such assignments and statements need to be documented explicitly in structures of a schema rather than free text, depends on whether this information should be accessible by structured queries.

This class allows for the documentation of how the respective assignment came about, and whose opinion it was. Note that all instances of properties described in a knowledge base are the opinion of someone. Per default, they are the opinion of the team maintaining the knowledge base. This fact must not individually be registered for all instances of properties provided by the maintaining team, because it would result in an endless recursion of whose opinion was the description of an opinion. Therefore, the use of instances of E13 Attribute Assignment marks the fact, that the maintaining team is in general neutral to the validity of the respective assertion, but registers someone else's opinion and how it came about.

All properties assigned in such an action can also be seen as directly relating the respective pair of items or concepts. Multiple use of instances of E13 Attribute Assignment may possibly lead to a collection of contradictory values.

All cases of properties in this model that are also described indirectly through a subclass of E13 Attribute Assignment are characterised as "short cuts" of a path via this subclass. This redundant modelling of two alternative views is preferred because many implementations may have good reasons to model either the action of assertion or the short cut, and the relation between both alternatives can be captured by simple rules.

Examples:

- the examination of MS Sinai Greek 418 by Nicholas Pickwoad in November 2003 (Honey & Pickwoad-, 2010)

- the assessment of the current ownership of Martin Doerr's silver cup in February 1997 (fictitious)

In First Order Logic:

$E13(x) \Rightarrow E7(x)$

Properties:

P140 assigned attribute to (was attributed by): E1 CRM Entity
P141 assigned (was assigned by): E1 CRM Entity
P177 assigned property type E55 Type

E14 Condition Assessment

Subclass of:

E13 Attribute Assignment

Scope note:

This class describes the act of assessing the state of preservation of an object during a particular period.

The condition assessment may be carried out by inspection, measurement or through historical research. This class is used to document circumstances of the respective assessment that may be relevant to interpret its quality at a later stage, or to continue research on related documents.

Examples:

- last year's inspection of humidity damage to the frescos in the St. George chapel in our village (fictitious)
- the condition assessment of the endband cores of MS Sinai Greek 418 by Nicholas Pickwood in November 2003 (Honey & Pickwood, 2010)
- the condition assessment of the cover of MS Sinai Greek 418 by Nicholas Pickwood in November 2003 (Honey & Pickwood, 2010)

In First Order Logic:

$E14(x) \Rightarrow E13(x)$

Properties:

P34 concerned (was assessed by): E18 Physical Thing
P35 has identified (identified by): E3 Condition State

E15 Identifier Assignment

Subclass of:

E13 Attribute Assignment

Scope note:

This class comprises activities that result in the allocation of an identifier to an instance of E1 CRM Entity. Instances of E15 Identifier Assignment may include the creation of the identifier from multiple constituents, which themselves may be instances of E41 Appellation. The syntax and kinds of constituents to be used may be declared in a rule constituting an instance of E29 Design or Procedure.

Examples of such identifiers include Find Numbers, Inventory Numbers, uniform titles in the sense of librarianship and Digital Object Identifiers (DOI). Documenting the act of identifier assignment and deassignment is especially useful when objects change custody or the identification system of an organization is changed. In order to keep track of the identity of things in such cases, it is important to document by whom, when and for what purpose an identifier is assigned to an item.

The fact that an identifier is a preferred one for an organisation can be expressed by using the property E1 CRM Entity. *P48 has preferred identifier (is preferred identifier of):* E42 Identifier. It can better be expressed in a context independent form by assigning a suitable E55

Type, such as “preferred identifier assignment”, to the respective instance of E15 Identifier Assignment via the *P2 has type* property.

Examples:

- replacement of the inventory number TA959a by GE34604 for a 17th century lament cloth at the Museum Benaki, Athens
- assigning the author-uniform title heading “Goethe, Johann Wolfgang von, 1749-1832. Faust. 1. Theil.” for the respective work
- on June 1, 2001 assigning the personal name heading “Guillaume, de Machaut, ca. 1300-1377” to Guillaume de Machaut (Kelly, 2014)

In First Order Logic:

$E15(x) \Rightarrow E13(x)$

Properties:

P37 assigned (was assigned by): E42 Identifier

P38 deassigned (was deassigned by): E42 Identifier

P142 used constituent (was used in): E90 Symbolic Object

E16 Measurement

Subclass of:

E13 Attribute Assignment

Scope note:

This class comprises actions measuring quantitative physical properties and other values that can be determined by a systematic, objective procedure of direct observation of particular states of physical reality.

An instance of E16 Measurement may use simple counting or tools, such as yardsticks or radiation detection devices. The interest is in the method and care applied, so that the reliability of the result may be judged at a later stage, or research continued on the associated documents. The date of the event is important for dimensions, which may change value over time, such as the length of an object subject to shrinkage. Methods and devices employed should be associated with instances of E16 Measurement by properties such as *P33 used specific technique*: E29 Design or Procedure, *P125 used object of type*: E55 Type, *P16 used specific object (was used for)*: E70 Thing, whereas basic techniques such as “carbon 14 dating” should be encoded using *P2 has type (is type of)*: E55 Type. Details of methods and devices reused or reusable in other instances of E16 Measurement should be documented for these entities rather than the measurements themselves, whereas details of particular execution may be documented by free text or by instantiating adequate sub-activities, if the detail may be of interest for an overarching query.

Regardless whether a measurement is made by an instrument or by human senses, it represents the initial transition from physical reality to information without any other documented information object in between within the reasoning chain that would represent the result of the interaction of the observer or device with reality. Therefore, determining properties of an instance of E90 Symbolic Object is regarded as an instance of E13 Attribute Assignment, which may be inferred from observing and measuring representative carriers. In the case that the carrier can be named, the property *P16 used specific object (was used for)*: should be used to indicate the instance(s) of E18 Physical Thing that was used as the empirical basis for the attribute assignment. For instance, inferring properties of depicted items using image material, such as satellite images, is not regarded as an instance of E16 Measurement, but as a subsequent instance of E13 Attribute Assignment. Rather, only the production of the images,

understood as arrays of radiation intensities, is regarded as an instance of E16 Measurement. The same reasoning holds for other sensor data.

Examples:

- measurement of the height of silver cup 232 on the 31st August 1997 (fictitious)
- the carbon 14 dating of the "Schoeninger Speer II" in 1996 [The carbon 14 dating of an approximately 400.000 year old complete Old Palaeolithic wooden spear found in Schoeningen, Niedersachsen, Germany, in 1995.] (Kouwenhoven, 1997)

In First Order Logic:

$E16(x) \Rightarrow E13(x)$

Properties:

P39 measured (was measured by): E18 Physical Thing
P40 observed dimension (was observed in): E54 Dimension

E17 Type Assignment

Subclass of:

E13 Attribute Assignment

Scope note:

This class comprises the actions of classifying items of whatever kind. Such items include objects, specimens, people, actions and concepts.

This class allows for the documentation of the context of classification acts in cases where the value of the classification depends on the personal opinion of the classifier, and the date that the classification was made. This class also encompasses the notion of "determination," i.e., the systematic and molecular identification of a specimen in biology.

Examples:

- the first classification of object GE34604 as Lament Cloth at the Museum Benaki, Athens
- the determination of a cactus in Martin Doerr's garden as '*Cereus hildmannianus* K. Schumann', July 2003

In First Order Logic:

$E17(x) \Rightarrow E13(x)$

Properties:

P41 classified (was classified by): E1 CRM Entity
P42 assigned (was assigned by): E55 Type

E18 Physical Thing

Subclass of:

E72 Legal Object

Superclass of:

E19 Physical Object
E24 Physical Human-Made Thing
E26 Physical Feature

Scope note:

This class comprises all persistent physical items with a relatively stable form, human-made or natural.

Depending on the existence of natural boundaries of such things, the CIDOC CRM distinguishes the instances of E19 Physical Object from instances of E26 Physical Feature, such as holes, rivers, pieces of land etc. Most instances of E19 Physical Object can be moved (if not too heavy), whereas features are integral to the surrounding matter.

An instance of E18 Physical Thing occupies not only a particular geometric space at any instant of its existence, but in the course of its existence it also forms a trajectory through spacetime, which occupies a real, that is phenomenal, volume in spacetime. We include in the occupied space the space filled by the matter of the physical thing and all its inner spaces, such as the interior of a box. For the purpose of more detailed descriptions of the presence of an instance of E18 Physical Thing in space and time it can be associated with its specific instance of E92 Spacetime Volume by the property *P196 defines (is defined by)*.

The CIDOC CRM is generally not concerned with amounts of matter in fluid or gaseous states, as long as they are not confined in an identifiable way for an identifiable minimal time-span.

Examples:

- the Cullinan Diamond (E19) (Scarratt and Shor, 2006)
- the cave “Ideon Andron” in Crete (E26) (Smith, 1844-49)
- the Mona Lisa (E22) (Mohen, 2006)

In First Order Logic:

$E18(x) \Rightarrow E72(x)$

Properties:

P44 has condition (is condition of): E3 Condition State
P45 consists of (is incorporated in): E57 Material
P46 is composed of (forms part of): E18 Physical Thing
P49 has former or current keeper (is former or current keeper of): E39 Actor
P50 has current keeper (is current keeper of): E39 Actor
P51 has former or current owner (is former or current owner of): E39 Actor
P52 has current owner (is current owner of): E39 Actor
P53 has former or current location (is former or current location of): E53 Place
P59 has section (is located on or within): E53 Place
P128 carries (is carried by): E90 Symbolic Object
P156 occupies (is occupied by): E53 Place
P196 defines (is defined by): E92 Spacetime Volume

E19 Physical Object

Subclass of:

E18 Physical Thing

Superclass of:

E20 Biological Object
E22 Human-Made Object

Scope note:

This class comprises items of a material nature that are units for documentation and have physical boundaries that separate them completely in an objective way from other objects.

The class also includes all aggregates of objects made for functional purposes of whatever kind, independent of physical coherence, such as a set of chessmen. Typically, instances of E19 Physical Object can be moved (if not too heavy).

In some contexts, such objects, except for aggregates, are also called “bona fide objects” (Smith & Varzi, 2000, pp.401-420), i.e., naturally defined objects.

The decision as to what is documented as a complete item, rather than by its parts or components, may be a purely administrative decision or may be a result of the order in which the item was acquired.

Examples:

- Aphrodite of Milos (E22) (Kousser, 2005)
- the Cullinan Diamond (Scarratt and Shor, 2006)
- Apollo 13 at the time of launch (E22) (Lovell and Kluger, 1994)

In First Order Logic:

$E19(x) \Rightarrow E18(x)$

Properties:

P54 has current permanent location (is current permanent location of): E53 Place

P55 has current location (currently holds): E53 Place

P56 bears feature (is found on): E26 Physical Feature

P57 has number of parts: E60 Number

E20 Biological Object

Subclass of:

E19 Physical Object

Superclass of:

E21 Person

Scope note:

This class comprises individual items of a material nature, which live, have lived or are natural products of or from living organisms.

Artificial objects that incorporate biological elements, such as Victorian butterfly frames, can be documented as both instances of E20 Biological Object and E22 Human-Made Object.

Examples:

- me (fictitious)
- Tut-Ankh-Amun (Edwards and Boltin, 1979)
- Boukephalus [Horse of Alexander the Great] (Lamb, 2005)
- petrified dinosaur excrement PA1906-344

In First Order Logic:

$E20(x) \Rightarrow E19(x)$

E21 Person

Subclass of:

E20 Biological Object

E39 Actor

Scope note:

This class comprises real persons who live or are assumed to have lived.

Legendary figures that may have existed, such as Ulysses and King Arthur, fall into this class if the documentation refers to them as historical figures. In cases where doubt exists as to whether several persons are in fact identical, multiple instances can be created and linked to

indicate their relationship. The CIDOC CRM does not propose a specific form to support reasoning about possible identity.

In a bibliographic context, a name presented following the conventions usually employed for personal names will be assumed to correspond to an actual real person (an instance of E21 Person), unless evidence is available to indicate that this is not the case. The fact that a persona may erroneously be classified as an instance of E21 Person does not imply that the concept comprises personae.

Examples:

- Tut-Ankh-Amun (Edwards and Boltin, 1979)
- Nelson Mandela (Brown and Hort, 2006)

In First Order Logic:

$E21(x) \Rightarrow E20(x)$
 $E21(x) \Rightarrow E39(x)$

Properties:

P152 has parent (is parent of): E21 Person

E22 Human-Made Object

Subclass of:

E19 Physical Object
E24 Physical Human-Made Thing

Scope note:

This class comprises all persistent physical objects of any size that are purposely created by human activity and have physical boundaries that separate them completely in an objective way from other objects.

The class also includes all aggregates of objects made for functional purposes of whatever kind, independent of physical coherence, such as a set of chessmen.

Examples:

- the Rosetta Stone (E22)
- LNER Class A4 4468 Mallard [the World's fastest steam locomotive, preserved at the National Railway Museum of York, UK] (Solomon, 2003)
- the Portland Vase (Walker, 2004)

In First Order Logic:

$E22(x) \Rightarrow E19(x)$
 $E22(x) \Rightarrow E24(x)$

E24 Physical Human-Made Thing

Subclass of:

E18 Physical Thing
E71 Human-Made Thing

Superclass of:

E22 Human-Made Object
E25 Human-Made Feature
E78 Curated Holding

Scope Note:

This class comprises all persistent physical items of any size that are purposely created by human activity. This class comprises, besides others, Human-Made objects, such as a sword, and Human-Made features, such as rock art. For example, a “cup and ring” carving on bedrock is regarded as instance of E24 Physical Human-Made Thing.

Instances of Human-Made thing may be the result of modifying pre-existing physical things, preserving larger parts or most of the original matter and structure, which poses the question if they are new or even Human-Made, the respective interventions of production made on such original material should be obvious and sufficient to regard that the product has a new, distinct identity and intended function and is human-made. Substantial continuity of the previous matter and structure in the new product can be documented by describing the production process also as an instance of E81 Transformation.

Whereas interventions of conservation and repair are not regarded to produce a new Human-Made thing, the results of preparation of natural history specimens that substantially change their natural or original state should be regarded as physical Human-Made things, including the uncovering of petrified biological features from a solid piece of stone. On the other side, scribbling a museum number on a natural object should not be regarded to make it Human-Made. This notwithstanding, parts, sections, segments, or features of a physical Human-Made thing may continue to be non-Human-Made and preserved during the production process, for example natural pearls used as a part of an eardrop.

Examples:

- the Forth Railway Bridge (Shipway, Bouch, Baker and Fowler, 1990).
- the Channel Tunnel (E25) (Holliday, Marcou and Vickerman, 1991)
- the Palace of Knossos (Evans, 1921)
- the Coliseum in Rome, Italy (Hopkins and Beard, 2011)
- the Historical Collection of the Museum Benaki in Athens (E78) (Georgoula, 2005)
- the Rosetta Stone (E22)
- my paperback copy of Crime & Punishment (E22) (fictitious)
- the computer disk at ICS-FORTH that stores the canonical Definition of the CIDOC CRM v.3.2 (E22)
- my empty DVD disk (E22) (fictitious)

In First Order Logic:

$E24(x) \Rightarrow E18(x)$

$E24(x) \Rightarrow E71(x)$

Properties:

P62 depicts (is depicted by): E1 CRM Entity
(P62.1 mode of depiction: E55 Type)

P65 shows visual item (is shown by): E36 Visual Item

E25 Human-Made Feature

Subclass of:

E24 Physical Human-Made Thing

E26 Physical Feature

Scope Note:

This class comprises physical features that are purposely created by human activity, such as scratches, artificial caves, artificial water channels, etc. In particular, it includes the information encoding features on mechanical or digital carriers.

Examples:

- the Manchester Ship Canal (Farnie, 1980)
- Michael Jackson's nose following plastic surgery
- the laser-readable "pits" engraved June 2014 on Martin Doerr's CD-R, copying songs of Edith Piaf.
- the carved letters on the Rosetta Stone

In First Order Logic:

$E25(x) \Rightarrow E24(x)$

$E25(x) \Rightarrow E26(x)$

E26 Physical Feature

Subclass of:

E18 Physical Thing

Superclass of:

E25 Human-Made Feature

E27 Site

Scope Note:

This class comprises identifiable features that are physically attached in an integral way to particular physical objects.

Instances of E26 Physical Feature share many of the attributes of instances of E19 Physical Object. They may have a one-, two- or three-dimensional geometric extent, but there are no natural borders that separate them completely in an objective way from the carrier objects. For example, a doorway is a feature but the door itself, being attached by hinges, is not.

Instances of E26 Physical Feature can be features in a narrower sense, such as scratches, holes, reliefs, surface colours, reflection zones in an opal crystal or a density change in a piece of wood. In the wider sense, they are portions of particular objects with partially imaginary borders, such as the core of the Earth, an area of property on the surface of the Earth, a landscape or the head of a contiguous marble statue. They can be measured and dated, and it is sometimes possible to state who or what is or was responsible for them. They cannot be separated from the carrier object, but a segment of the carrier object may be identified (or sometimes removed) carrying the complete feature.

This definition coincides with the definition of "fiat objects" (Smith & Varzi, 2000, pp.401-420), with the exception of aggregates of "bona fide objects".

Examples:

- the cave of Dirou, Mani, Greece (Psimenos, 2005)
- the temple in Abu Simbel before its removal, which was carved out of solid rock (E25) (Hawass, 2000)
- Albrecht Duerer's signature on his painting of Charles the Great (E25) (Strauss, 1974)
- the damage to the nose of the Great Sphinx in Giza (Temple, 2009)
- Michael Jackson's nose prior to plastic surgery

In First Order Logic:

$E26(x) \Rightarrow E18(x)$

E27 Site

Subclass of:

[E26 Physical Feature](#)

Scope Note:

This class comprises pieces of land or sea floor.

In contrast to the purely geometric notion of E53 Place, this class describes constellations of matter on the surface of the Earth or other celestial body, which can be represented by photographs, paintings and maps.

Instances of E27 Site are composed of relatively immobile material items and features in a particular configuration at a particular location.

Examples:

- the Amazon river basin (Hegen, 1966)
- Knossos (Evans, 1921)
- the Apollo 11 landing site (Siegler and Smrekar, 2014)
- Heathrow Airport (Wicks, 2014)
- the submerged harbour of the Minoan settlement of Gournia, Crete (Watrous, 2012)
- the island of Crete

In First Order Logic:

$E27(x) \Rightarrow E26(x)$

E28 Conceptual Object

Subclass of:

[E71 Human-Made Thing](#)

Superclass of:

[E55 Type](#)
[E89 Propositional Object](#)
[E90 Symbolic Object](#)

Scope note:

This class comprises non-material products of our minds and other human produced data that have become objects of a discourse about their identity, circumstances of creation or historical implication. The production of such information may have been supported by the use of technical devices such as cameras or computers.

Characteristically, instances of this class are created, invented or thought by someone, and then may be documented or communicated between persons. Instances of E28 Conceptual Object have the ability to exist on more than one particular carrier at the same time, such as paper, electronic signals, marks, audio media, paintings, photos, human memories, etc.

They cannot be destroyed. They exist as long as they can be found on at least one carrier or in at least one human memory. Their existence ends when the last carrier and the last memory are lost.

Examples:

- Beethoven's "Ode an die Freude" (Ode to Joy) (E73) (Kershaw, 1999)
- the definition of "ontology" in the Oxford English Dictionary (E73) (Oxford University Press, 1989)
- the knowledge about the victory at Marathon carried by the famous runner (E89) (Lagos & Karyanos, 2020)

[Explanation note: In the following examples we illustrate the distinction between a propositional object, its names and its encoded forms. The Maxwell equations (Ball, 1962) are a good example, because they belong to the fundamental laws of physics and their mathematical content yields identical, unambiguous results regardless formulation and encoding.]

- “Maxwell equations” (E41) [preferred subject access point from LCSH, <http://lccn.loc.gov/sh85082387>, accessed 18th April 2021. This is only the name for the Maxwell equations as standardized by the Library of Congress and not the equations themselves.]
- “Equations, Maxwell” (E41) [variant subject access point from LCSH, <http://lccn.loc.gov/sh85082387>, accessed 18th April 2021. This is another name for the equation standardized by the Library of Congress and not the equations themselves.]
- Maxwell's equations (E89) [This is the propositional content of the equations proper, independent of any particular notation or mathematical formalism.] (Ball, 1962)
- The encoding of Maxwells equations as in <https://upload.wikimedia.org/wikipedia/commons/c/c4/Maxwell%27sEquations.svg> (E73) [accessed 18th April 2021. This is one possible symbolic encoding of the propositional content of the equations.]

In First Order Logic:

$E28(x) \Rightarrow E71(x)$

E29 Design or Procedure

Subclass of:

E73 Information Object

Scope note:

This class comprises documented plans for the execution of actions in order to achieve a result of a specific quality, form or contents. In particular, it comprises plans for deliberate human activities that may result in new instances of E71 Human-Made Thing or for shaping or guiding the execution of an instance of E7 Activity.

Instances of E29 Design or Procedure can be structured in parts and sequences or depend on others.

This is modelled using P69 has association with (is associated with): E29 Design or Procedure.

Designs or procedures can be seen as one of the following

- 1 A schema for the activities it describes
- 2 A schema of the products that result from their application.
- 3 An independent intellectual product that may have never been applied, such as Leonardo da Vinci's famous plans for flying machines.

Because designs or procedures may never be applied or only partially executed, the CIDOC CRM models a loose relationship between the plan and the respective product.

Examples:

- the ISO standardisation procedure
- the musical notation for Beethoven's “Ode to Joy” (Kershaw, 1999)
- the architectural drawings for the Kölner Dom (Cologne Cathedral) in Cologne, Germany (Wolff, 1999)

- the drawing on the folio 860 of the Codex Atlanticus from Leonardo da Vinci, 1486-1490, kept in the Biblioteca Ambrosiana in Milan

In First Order Logic:

$E29(x) \Rightarrow E73(x)$

Properties:

P68 foresees use of (use foreseen by): E57 Material
P69 has association with (is associated with): E29 Design or Procedure
(P69.1 has type: E55 Type)

E30 Right

Subclass of:

E89 Propositional Object

Scope Note:

This class comprises legal privileges concerning material and immaterial things or their derivatives.

These include reproduction and property rights.

Examples:

- copyright held by ISO on ISO/CD 21127
- ownership of the "Mona Lisa" by the museum of the Louvre, Paris, France

In First Order Logic:

$E30(x) \Rightarrow E89(x)$

E31 Document

Subclass of:

E73 Information Object

Superclass of:

E32 Authority Document

Scope note:

This class comprises identifiable immaterial items that make propositions about reality.

These propositions may be expressed in text, graphics, images, audiograms, videograms or by other similar means. Documentation databases are regarded as instances of E31 Document.

This class should not be confused with the concept "document" in Information Technology, which is compatible with E73 Information Object.

Examples:

- the Encyclopaedia Britannica (E32) (Kogan, 1958)
- the image content of the photo of the Allied Leaders at Yalta published by UPI, 1945 (E36)
- Domesday Book [a manuscript record of the "Great Survey" of much of England and parts of Wales completed in 1086 by order of King William the Conqueror] (Hallam 1986)

In First Order Logic:

$E31(x) \Rightarrow E73(x)$

Properties:

P70 documents (is documented in): E1 CRM Entity

E32 Authority Document

Subclass of:

[E31](#) Document

Scope note:

This class comprises encyclopaedia, thesauri, authority lists and other documents that define terminology or conceptual systems for consistent use.

Examples:

- Webster's Dictionary (Herbert, 1994)
- Getty Art and Architecture Thesaurus (Getty Trust, 1990)
- the CIDOC Conceptual Reference Model (Gergatsoulis et al., 2010)

In First Order Logic:

$E32(x) \Rightarrow E31(x)$

Properties:

[P71](#) lists (is listed in): [E1](#) CRM Entity

E33 Linguistic Object

Subclass of:

[E73](#) Information Object

Superclass of:

[E34](#) Inscription
[E35](#) Title

Scope note:

This class comprises identifiable expressions in natural language or languages.

Instances of E33 Linguistic Object can be expressed in many ways: e.g., as written texts, recorded speech or sign language. However, the CIDOC CRM treats instances of E33 Linguistic Object independently from the medium or method by which they are expressed. Expressions in formal languages, such as computer code or mathematical formulae, are not treated as instances of E33 Linguistic Object by the CIDOC CRM. These should be modelled as instances of E73 Information Object.

In general, an instance of E33 Linguistic Object may also contain non-linguistic information, often of artistic or aesthetic value. Only in cases in which the content of an instance of E33 Linguistic Object can completely be expressed by a series of binary-encoded symbols, its content may be documented within a respective knowledge base by the property *P190 has symbolic content*: E62 String. Otherwise, it should be understood as an identifiable digital resource only available independently from the respective knowledge base.

In other cases, such as pages of an illuminated manuscript or recordings containing speech in a language supported by a writing system, the linguistic part of the content of an instance of E33 Linguistic Object may be documented within a respective knowledge base in a note by *P3 has note*: E62 String. Otherwise, it may be described using the property *P165 incorporates (is incorporated in)*: E73 Information Object as a different object with its own identity.

Examples:

- the text of the Ellesmere Chaucer manuscript (Hilmo, 2019)
- the lyrics of the song "Blue Suede Shoes" (Cooper, 2008)
- the text of the "Jabberwocky" by Lewis Carroll (Carroll, 1981)

- the text of "Doktoro Jekyll kaj Sinjoro Hyde" [an Esperanto translation of Dr Jekyll and Mr Hyde]. (Stevenson, Morrison and Mann, 1909)
- the free dialog in the local dialect recorded in 1958, Telemark, Norway stored on tape or.7-89.s1 (00.15:46-00:34), The Language Collection at the University Library in Bergen, Norway (as by 2020)

In First Order Logic:

$E33(x) \Rightarrow E73(x)$

Properties:

P72 has language (is language of): E56 Language

P73 has translation (is translation of): E33 Linguistic Object

E34 Inscription

Subclass of:

E33 Linguistic Object

E37 Mark

Scope note:

This class comprises recognisable, texts attached to instances of E24 Physical Human-Made Thing.

The transcription of the text can be documented in a note by *P3 has note: E62 String*. The alphabet used can be documented by *P2 has type: E55 Type*. This class does not intend to describe the idiosyncratic characteristics of an individual physical embodiment of an inscription, but the underlying prototype. The physical embodiment is modelled in the CIDOC CRM as instances of E24 Physical Human-Made Thing.

The relationship of a physical copy of a book to the text it contains is modelled using E18 Physical Thing. *P128 carries (is carried by): E33 Linguistic Object*.

Examples:

- “keep off the grass” [on a sign stuck in the lawn of the quad of Balliol College, Oxford, UK]
- the text published in Corpus Inscriptionum Latinarum V 895 (Mommsen, 1872)
- “Kilroy was here”

In First Order Logic:

$E34(x) \Rightarrow E33(x)$

$E34(x) \Rightarrow E37(x)$

E35 Title

Subclass of:

E33 Linguistic Object

E41 Appellation

Scope note:

This class comprises textual strings that within a cultural context can be clearly identified as titles due to their form. Being a subclass of E41 Appellation, E35 Title can only be used when such a string is actually used as a title of a work, such as a text, an artwork, or a piece of music.

Titles are proper noun phrases or verbal phrases, and should not be confused with generic object names such as “chair”, “painting” or “book” (the latter are common nouns that stand for

instances of E55 Type). Titles may be assigned by the creator of the work itself, or by a social group.

This class also comprises the translations of titles that are used as surrogates for the original titles in different social contexts.

Examples:

- “The Merchant of Venice” (McCullough, 2005)
- “Mona Lisa” (Mohen, Menu and Mottin, 2006)
- “La Pie” (Bortolatto, 1981)
- “Lucy in the Sky with Diamonds” (Lennon, 1967)

In First Order Logic:

$E35(x) \Rightarrow E33(x)$

$E35(x) \Rightarrow E41(x)$

E36 Visual Item

Subclass of:

E73 Information Object

Superclass of:

E37 Mark

Scope Note:

This class comprises the intellectual or conceptual aspects of recognisable marks, images and other visual works.

This class does not intend to describe the idiosyncratic characteristics of an individual physical embodiment of a visual item, but the underlying prototype. For example, a mark such as the ICOM logo is generally considered to be the same logo when used on any number of publications. The size, orientation and colour may change, but the logo remains uniquely identifiable. The same is true of images that are reproduced many times. This means that visual items are independent of their physical support.

The class E36 Visual Item provides a means of identifying and linking together instances of E24 Physical Human-Made Thing that carry the same visual qualities (symbols, marks or images etc.). The property *P62 depicts (is depicted by)* between E24 Physical Human-Made Thing and depicted subjects (E1 CRM Entity) is a shortcut of the more fully developed path from E24 Physical Human-Made Thing through *P65 shows visual item (is shown by)*, E36 Visual Item, *P138 represents (has representation)* to E1CRM Entity, which in addition captures the optical features of the depiction.

Examples:

- the visual appearance of Monet’s “La Pie” (Bortolatto, 1981)
- the Coca-Cola logo (E34)
- the Chi-Rho (E37)
- the communist red star (E37)
- the surface shape of Auguste Rodin’s statue “Le Penseur” [there exist more than 20 copies, even of different size. Therefore, this is a good example that it is only the common surface shape, an immaterial visual item, which justifies displaying these copies as works of Auguste Rodin. As usual practice, Rodin himself did not produce the bronze statue, but only the prototype model]

In First Order Logic:

$E36(x) \Rightarrow E73(x)$

Properties:

P138 represents (has representation): E1 CRM Entity
(P138.1 mode of representation: E55 Type)

E37 Mark

Subclass of:

E36 Visual Item

Superclass of:

E34 Inscription

Scope note:

This class comprises symbols, signs, signatures or short texts applied to instances of E24 Physical Human-Made Thing by arbitrary techniques, often in order to indicate such things as creator, owner, dedications, purpose or to communicate information generally. Instances of E37 Mark do not represent the actual image of a mark, but the abstract ideal (or archetype) as used for codification in reference documents forming cultural documentation.

This class specifically excludes features that have no semantic significance, such as scratches or tool marks. These should be documented as instances of E25 Human-Made Feature.

Examples:

- Minoan double axe mark (Lowe Fri, 2011)
- ©
- ☺

In First Order Logic:

$E37(x) \Rightarrow E36(x)$

E39 Actor

Subclass of:

E77 Persistent Item

Superclass of:

E21 Person
E74 Group

Scope note:

This class comprises people, either individually or in groups, who have the potential to perform intentional actions of kinds for which someone may be held responsible.

Examples:

- London and Continental Railways (E74)
- the Governor of the Bank of England in 1975 (E21)
- Sir Ian McKellan-McKellen (E21) (Gibson, 1986)

In First Order Logic:

$E39(x) \Rightarrow E77(x)$

Properties:

P74 has current or former residence (is current or former residence of): E53 Place
P75 possesses (is possessed by): E30 Right
P76 has contact point (provides access to): E41 Appellation

E41 Appellation

Subclass of:

[E90](#) Symbolic Object

Superclass of:

[E35](#) Title

[E42](#) Identifier

[E61](#) Time Primitive

[E94](#) Space Primitive

[E95](#) Spacetime Primitive

Scope note:

This class comprises signs, either meaningful or not, or arrangements of signs following a specific syntax, that are used or can be used to refer to and identify a specific instance of some class or category within a certain context.

Instances of E41 Appellation do not identify things by their meaning, even if they happen to have one, but instead by convention, tradition, or agreement. Instances of E41 Appellation are cultural constructs; as such, they have a context, a history, and a use in time and space by some group of users. A given instance of E41 Appellation can have alternative forms, i.e., other instances of E41 Appellation that are always regarded as equivalent independent from the thing it denotes.

Different languages may use different appellations for the same thing, such as the names of major cities. Some appellations may be formulated using a valid noun phrase of a particular language. In these cases, the respective instances of E41 Appellation should also be declared as instances of E33 Linguistic Object. Then the language using the appellation can be declared with the property *P72 has language*: E56 Language.

Instances of E41 Appellation may be used to identify any instance of E1 CRM Entity and sometimes are characteristic for instances of more specific subclasses E1 CRM Entity, such as for instances of E52 Time-Span (for instance “dates”), E39 Actor, E53 Place or E28 Conceptual Object. Postal addresses and E-mail addresses are characteristic examples of identifiers used by services transporting things between clients.

Even numerically expressed identifiers for extents in space or time are also regarded as instances of E41 Appellation, such as Gregorian dates or spatial coordinates, even though they allow for determining some time or location by a known procedure starting from a reference point and by virtue of that fact play a double role as instances of E59 Primitive Value.

E41 Appellation should not be confused with the act of naming something. Cf. E15 Identifier Assignment

Examples:

- "Martin"
- "Aequae Sulis Minerva"
- "the Merchant of Venice" (E35) (McCullough, 2005)
- "Spigelia marilandica (L.) L." [not the species, just the name] (Hershberger, Robacker and Jenkins, 2015)
- "information science" [not the science itself, but the name through which we refer to it in an English-speaking context]

- “安” [Chinese “an”, meaning “peace”]
- “6°5’29”N 45°12’13”W” [example of a spatial coordinate]
- “Black queen’s bishop 4” [chess coordinate, example of an identifier in a conceptual space (E89)]
- “19-MAR-1922” [example of date]
- “+41 22 418 5571” [example of contact point]
- “weasel@paveprime.com” [example of contact point]
- “CH-1211, Genève” [example of place appellation]
- “1-29-3 Otsuka, Bunkyo-ku, Tokyo, 121, Japan” [example of a postal address]
- “the poop deck of H.M.S Victory” [example of a section definition on a human-made object (E22)]
- “the Venus de Milo’s left buttock” [example of a section definition on a human-made object (E22)]

In First Order Logic:

$E41(x) \Rightarrow E90(x)$

Properties:

P139 has alternative form: E41 Appellation
(P139.1 has type: E55 Type)

E42 Identifier

Subclass of:

E41 Appellation

Scope note:

This class comprises strings or codes assigned to instances of E1 CRM Entity in order to identify them uniquely and permanently within the context of one or more organisations. Such codes are often known as inventory numbers, registration codes, etc. and are typically composed of alphanumeric sequences. Postal addresses, telephone numbers, [urls-URLs](#) and e-mail addresses are characteristic examples of identifiers used by services transporting things between clients.

The class E42 Identifier is not normally used for machine-generated identifiers used for automated processing unless these are also used by human agents.

Examples:

- “MM.GE.195”
- “13.45.1976”
- “OXCMS: 1997.4.1” (fictitious)
- “ISSN 0041-5278” [Identifier for “The [Unesco-UNESCO Courier-Courier](#) (Print)”]
- “ISRC FIFIN8900186” [Identifier for : Kraft (29 min 14 s) / Magnus Lindberg, comp. ; Toimii Ensemble ; Swedish Radio symphony orchestra ; Esa-Pekka Salonen, dir.]
- Shelf mark “Res 8 P 10”
- “Guillaume de Machaut (1300?-1377)” [a controlled personal name heading that follows the French rules] (Reaney, 1974)
- “+41 22 418 5571”
- weasel@paveprime.com
- “Rue David Dufour 5, CH-1211, Genève”
- “1-29-3 Otsuka, Bunkyo-ku, Tokyo, 121, Japan”

In First Order Logic:

$E42(x) \Rightarrow E41(x)$

E52 Time-Span

Subclass of:

E1 CRM Entity

Scope note:

This class comprises abstract temporal extents, in the sense of Galilean physics, having a beginning, an end and a duration.

Instances of E52 Time-Span have no semantic connotations about phenomena happening within the temporal extent they represent. They do not convey any meaning other than a positioning on the “time-line” of chronology. The actual extent of an instance of E52 Time-Span can be approximated by properties of E52 Time-Span giving inner and outer bounds in the form of dates (instances of E61 Time Primitive). Comparing knowledge about time-spans is fundamental for chronological reasoning.

Some instances of E52 Time-Span may be defined as the actual, in principle observable, temporal extent of instances of E2 Temporal Entity via the property *P4 has time-span (is time-span of)*: E52 Time-Span. They constitute phenomenal time-spans as defined in CRMgeo (Doerr & Hiebel 2013). Since our knowledge of history is imperfect and physical phenomena are fuzzy in nature, the extent of phenomenal time-spans can only be described in approximation. An extreme case of approximation, might, for example, define an instance of E52 Time-Span having unknown beginning, end and duration. It may, nevertheless, be associated with other descriptions by which we can infer knowledge about it, such as in relative chronologies.

Some instances of E52 may be defined precisely as representing a declaration of a temporal extent, as, for instance, done in a business contract. They constitute declarative time-spans as defined in CRMgeo (Doerr & Hiebel 2013) and can be described via the property E61 Time Primitive *P170 defines time (time is defined by)*: E52 Time-Span.

When used as a common E52 Time-Span for two events, it will nevertheless describe them as being simultaneous, even if nothing else is known.

Examples:

- 1961
- From 12-17-1993 to 12-8-1996
- 14h30 – 16h22 4th July 1945
- 9.30 am 1.1.1999 to 2.00 pm 1.1.1999
- the time-span of the Ming Dynasty (Chan, 2011)

In First Order Logic:

$E52(x) \Rightarrow E1(x)$

Properties:

P79 beginning is qualified by: E62 String
P80 end is qualified by: E62 String
P81 ongoing throughout: E61 Time Primitive
P82 at some time within: E61 Time Primitive
P86 falls within (contains): E52 Time-Span
P191 had duration (was duration of): E54 Dimension

E53 Place

Subclass of:

E1 CRM Entity

Scope note:

This class comprises extents in the natural space we live in, in particular on the surface of the Earth, in the pure sense of physics: independent from temporal phenomena and matter. They may serve describing the physical location of things or phenomena or other areas of interest. Geometrically, instances of E53 Place constitute single contiguous areas or a finite aggregation of disjoint areas in space which are each individually contiguous. They may have fuzzy boundaries.

The instances of E53 Place are usually determined by reference to the position of “immobile” objects such as buildings, cities, mountains, rivers, or dedicated geodetic marks, but may also be determined by reference to mobile objects. A Place can be determined by combining a frame of reference and a location with respect to this frame.

It is sometimes argued that instances of E53 Place are best identified by global coordinates or absolute reference systems. However, relative references are often more relevant in the context of cultural documentation and tend to be more precise. In particular, we are often interested in position in relation to large, mobile objects, such as ships. For example, the Place at which Nelson died is known with reference to a large mobile object – H.M.S Victory. A resolution of this Place in terms of absolute coordinates would require knowledge of the movements of the vessel and the precise time of death, either of which may be revised, and the result would lack historical and cultural relevance.

Any instance of E18 Physical Thing can serve as a frame of reference for an instance of E53 Place. This may be documented using the property *P157 is at rest relative to (provides reference space for)*.

Examples:

- the extent of the UK in the year 2003
- the position of the hallmark on the inside of my wedding ring (fictitious)
- the place referred to in the phrase: “Fish collected at three miles north of the confluence of the Arve and the Rhone”
- here -> <- [the place between these two arrows in one of the reader's paper copy of this document. Each copy constitutes a different place of this spot.]

In First Order Logic:

$E53(x) \Rightarrow E1(x)$

Properties:

P89 falls within (contains): E53 Place
P121 overlaps with: E53 Place
P122 borders with: E53 Place
P157 is at rest relative to (provides reference space for): E18 Physical Thing
P168 place is defined by (defines place): E94 Space Primitive
P171 at some place within: E94 Space Primitive
P172 contains: E94 Space Primitive
P189 approximates (is approximated by): E53 Place

E54 Dimension

Subclass of:

[E1](#) CRM Entity

Superclass of:

[E97](#) Monetary Amount

Scope note:

This class comprises quantifiable properties that can be measured by some calibrated means and can be approximated by values, i.e., by points or regions in a mathematical or conceptual space, such as natural or real numbers, RGB values etc.

An instance of E54 Dimension represents the empirical or theoretically derived quantity, including the precision tolerances resulting from the particular method or calculation. The identity of an instance of E54 Dimension depends on the method of its determination because each method may produce different values even when determining comparable qualities. For instance, the wingspan of a bird alive or dead is a different dimension. Thermoluminescence dating and Rehydroxylation [RHX] dating are different dimensions of temporal distance from now, even if they aim at dating the same object. The method of determination should be expressed using the property *P2 has type (is type of)*. Note that simple terms such as “diameter” or “length” are normally insufficient to unambiguously describe a respective dimension. In contrast, “maximum linear extent” may be sufficient.

The properties of the class E54 Dimension allow for expressing the numerical approximation of the values of instances of E54 Dimension adequate to the precision of the applied method of determination. If the respective quantity belongs to a non-discrete space according to the laws of physics, such as spatial distances, it is recommended to record them as approximations by intervals or regions of indeterminacy enclosing the assumed true values. For instance, a length of 5 cm may be recorded as 4.5-5.5 cm, according to the precision of the respective observation. Note, that comparability of values described in different units depends critically on the representation as value regions.

Numerical approximations in archaic instances of E58 Measurement Unit used in historical records should be preserved. Equivalents corresponding to current knowledge should be recorded as additional instances of E54 Dimension, as appropriate.

Examples:

- the weight of the Luxor Obelisk [250 metric tons]
- the vertical height of the statue of David by Michaelangelo [5.17 metres]
- the weight of the Great Star of Africa diamond [530.2 carats]
- the calibrated C14 date for the Shroud of Turin [AD1262-1312, 1303-1384]
- the horizontal diameter of the Stonehenge Sarsen Circle [33 metres] (Pryor, 2016)
- the length of the sides of the Great Pyramid at Giza [230.34 metres] (Lehner and Hawass, 2017)
- the duration of the time span of the Battle of Issos/Issus on 15th November 333 B.C.E. [less than 12 hours] (Howard, 2012)
- Christie’s hammer price, in British Pounds, for Vincent van Gogh's "Still Life: Vase with Fifteen Sunflowers" in London on 30th March 1987 (E97) [24.75 million GBP (British Pounds)]

In First Order Logic:

$E54(x) \Rightarrow E1(x)$

Properties:

P90 has value: E60 Number

P91 has unit (is unit of): E58 Measurement Unit

E55 Type

Subclass of:

E28 Conceptual Object

Superclass of:

E56 Language

E57 Material

E58 Measurement Unit

E99 Product Type

Scope note:

This class comprises concepts denoted by terms from thesauri and controlled vocabularies used to characterize and classify instances of CIDOC CRM classes. Instances of E55 Type represent concepts in contrast to instances of E41 Appellation which are used to name instances of CIDOC CRM classes.

E55 Type is the CIDOC CRM's interface to domain specific ontologies and thesauri. These can be represented in the CIDOC CRM as subclasses of E55 Type, forming hierarchies of terms, i.e., instances of E55 Type linked via *P127 has broader term (has narrower term)*: E55 Type. Such hierarchies may be extended with additional properties.

Examples:

- weight, length, depth [types for instances of E54]
- portrait, sketch, animation [types for instances of E36]
- French, English, German (E56)
- excellent, good, poor [types for instances of E3]
- Ford Model T, chop stick [types for instances of E22]
- cave, doline, scratch [types for instances of E26]
- poem, short story [types for instances of E33]
- wedding, earthquake, skirmish [types for instances of E5]

In First Order Logic:

$E55(x) \Rightarrow E28(x)$

Properties:

P127 has broader term (has narrower term): E55 Type

P150 defines typical parts of (define typical wholes for): E55 Type

E56 Language

Subclass of:

E55 Type

Scope note:

This class is a specialization of E55 Type and comprises the natural languages in the sense of concepts.

This type is used categorically in the model without reference to instances of it, i.e., the Model does not foresee the description of instances of instances of E56 Language, e.g.: “instances of Mandarin Chinese”.

It is recommended that internationally or nationally agreed codes and terminology are used to denote instances of E56 Language, such as those defined in ISO 639-~~12:2002-1998~~ and later versions.

Examples:

- ~~ell-~~ [Greek] (~~Palmer, 1980~~)
- ~~eng~~ [English] (~~Wilson, 1983~~)
- ~~epo~~ [Esperanto] (~~Nuessel, 2000~~)
- ~~es-spa~~ [Spanish] (~~Pineda, 1993~~)
- ~~frq-~~ [French] (~~Riekard, 1974~~)

In First Order Logic:

$E56(x) \Rightarrow E55(x)$

E57 Material

Subclass of:

E55 Type

Scope note:

This class is a specialization of E55 Type and comprises the concepts of materials.

Instances of E57 Material may denote properties of matter before its use, during its use, and as incorporated in an object, such as ultramarine powder, tempera paste, reinforced concrete. Discrete pieces of raw-materials kept in museums, such as bricks, sheets of fabric, pieces of metal, should be modelled individually in the same way as other objects. Discrete used or processed pieces, such as the stones from Nefer Titi's temple, should be modelled as parts (cf. *P46 is composed of (forms part of):* E18 Physical Thing).

This type is used categorically in the model without reference to instances of it, i.e., the Model does not foresee the description of instances of instances of E57 Material, e.g.: “instances of gold”.

It is recommended that internationally or nationally agreed codes and terminology are used.

Examples:

- brick (Gurcke, 1987)
- gold (Watson, 1990)
- aluminium (Norman, 1986)
- polycarbonate (Mhaske, 2011)
- resin (Barton, 1992)

In First Order Logic:

$E57(x) \Rightarrow E55(x)$

E58 Measurement Unit

Subclass of:

E55 Type

Superclass of:

E98 Currency

Scope Note:

This class is a specialization of E55 Type and comprises the types of measurement units: feet, inches, centimetres, litres, lumens, etc.

This type is used categorically in the model without reference to instances of it, i.e., the Model does not foresee the description of instances of instances of E58 Measurement Unit, e.g.: "instances of cm".

Système International (SI) units or internationally recognized non-SI terms should be used whenever possible, such as those defined by ISO80000:2009. Archaic Measurement Units used in historical records should be preserved.

Examples:

- cm [centimetre]
- km [kilometre]
- m [meter]
- m/s [meters per second] (Hau et al., 1999)
- A [Ampere]
- GRD [Greek Drachme] (E98) (Daniel, 2014)
- °C [degrees centigrade] (Beckman, 1998)

In First Order Logic:

$E58(x) \Rightarrow E55(x)$

E59 Primitive Value

Subclass of:

E1 CRM Entity

Superclass of:

E60 Number
E61 Time Primitive
E62 String
E94 Space Primitive
E95 Spacetime Primitive

Scope Note:

This class comprises values of primitive data types of programming languages or database management systems and data types composed of such values used as documentation elements, as well as their mathematical abstractions.

The instances of E59 Primitive Value and its subclasses are not considered elements of the universe of discourse the CIDOC CRM aims to define and [analyze](#). Rather, they play the role of a symbolic interface between the scope of the model and the world of mathematical and computational manipulations and the symbolic objects they define and handle.

In particular, they comprise lexical forms encoded as "strings" or series of characters and symbols based on encoding schemes (characterised by being a limited subset of the respective mathematical abstractions) such as UNICODE and values of datatypes that can be encoded in a lexical form, including quantitative specifications of time-spans and geometry. They have in common that instances of E59 Primitive Value define themselves by virtue of their encoded value, regardless of the nature of their mathematical abstractions.

Therefore, in an implementation, instances of E59 Primitive should be represented directly in the encoded symbolic form supported by the respective platform, such as a character string or a formatted date. They must not be represented in an implementation indirectly via, another a

universal resource identifier, which in turn is linked to the actual encoded symbolic form. In a concrete application, it is recommended that the primitive value system from a chosen implementation platform and/or data definition language be used to substitute for this class and its subclasses.

Examples:

- “ABCDEFGF” (E62)
- 3.14 (E60)
- 0 (E60)
- 1921-01-01 (E61)

In First Order Logic:

$E59(x) \Rightarrow E1(x)$

E60 Number

Subclass of:

E59 Primitive Value

Scope Note:

This class comprises any encoding of computable (algebraic) values such as integers, real numbers, complex numbers, vectors, tensors etc., including intervals of these values to express limited precision.

Numbers are fundamentally distinct from numerically expressed identifiers in continua, which are instances of E41 Appellation, such as Gregorian dates or spatial coordinates, even though their encoding may be similar. Instances of E60 Number can be combined with each other in algebraic operations to yield other instances of E60 Number, e.g., $1+1=2$. Identifiers in continua may be combined with numbers expressing distances to yield new identifiers, e.g., $1924-01-31 + 2 \text{ days} = 1924-02-02$. Cf. E54 Dimension.

Examples:

- 5
- $3+2i$
- $1.5e-04$
- $(0.5, -0.7,88)$

In First Order Logic:

$E60(x) \Rightarrow E59(x)$

E61 Time Primitive

Subclass of:

E41 Appellation
E59 Primitive Value

Scope Note:

This class comprises instances of E59 Primitive Value for time that should be implemented with appropriate validation, precision and references to temporal coordinate systems to express time in some context relevant to cultural and scientific documentation.

Instantiating different instances of E61 Time Primitive relative to the same instance of E52 ~~Time~~ Time-Span allows for the expression of multiple opinions/approximations of the same phenomenon. When representing different opinions/approximations of the E52 Time-Span of some E2 Temporal Entity, multiple instances of E61 Time Primitive should be instantiated

relative to one E52 Time-Span. Only one E52 Time-Span should be instantiated since there is only one real phenomenal time extent of any given temporal entity.

The instances of E61 Time Primitive are not considered as elements of the universe of discourse that the CIDOC CRM aims at defining and analysing. Rather, they play the role of a symbolic interface between the scope of this model and the world of mathematical and computational manipulations and the symbolic objects they define and handle.

Therefore, they must not be represented in an implementation by a universal identifier associated with a content model of different identity. In a concrete application, it is recommended that the primitive value system from a chosen implementation platform and/or data definition language be used to substitute for this class.

Examples:

- “1994 – 1997”
- “13th May 1768”
- “2000/01/01 00:00:59.7”
- “85th century BCE”

In First Order Logic:

$E61(x) \Rightarrow E41(x)$

$E61(x) \Rightarrow E59(x)$

Properties:

P170 defines time (time is defined by): E52 Time-Span

E62 String

Subclass of:

E59 Primitive Value

Scope Note:

This class comprises coherent sequences of binary-encoded symbols. They correspond to the content of an instance of E90 Symbolic object. Instances of E62 String represent only the symbol sequence itself. They may or may not contain a language code.

In contrast, instances of other subclasses of E59 Primitive value represent entities in mathematical spaces other than that of symbol sequences, by using binary-encoded symbols, such as date expressions or numbers in decimal encoding. For instance, different syntactic forms of a date expression may represent the same date but consist of different strings.

Examples:

- “the Quick Brown Fox Jumps Over the Lazy Dog”
- “6F 6E 54 79 70 31 0D 9E”

In First Order Logic:

$E62(x) \Rightarrow E59(x)$

E63 Beginning of Existence

Subclass of:

E5 Event

Superclass of:

E12 Production

E65 Creation

E66 Formation

E67 Birth
E81 Transformation

Scope note:

This class comprises events that bring into existence any instance of E77 Persistent Item.

It may be used for temporal reasoning about things (intellectual products, physical items, groups of people, living beings) beginning to exist; it serves as a hook for determination of a “terminus post quem” or “terminus ante quem”.

Examples:

- the birth of my child (E67) (fictitious)
- the birth of Snoopy, my dog (fictitious)
- the calving of the iceberg that sank the Titanic
- the construction of the Eiffel Tower (E12) (Tissandier, 1889)

In First Order Logic:

$E63(x) \Rightarrow E5(x)$

Properties:

P92 brought into existence (was brought into existence by): E77 Persistent Item

E64 End of Existence

Subclass of:

E5 Event

Superclass of:

E6 Destruction
E68 Dissolution
E69 Death
E81 Transformation

Scope note:

This class comprises events that end the existence of any instance of E77 Persistent Item.

It may be used for temporal reasoning about things (physical items, groups of people, living beings) ceasing to exist; it serves as a hook for determination of a “terminus post quem” or “terminus ante quem”. In cases where substance from an instance of E7764 Persistent Item continues to exist in a new form, the process would be documented as instances of E81 Transformation.

Examples:

- the death of Snoopy, my dog (fictitious)
- the melting of the snowman (E6)
- the burning of the Temple of Artemis in Ephesos by Herostratos in 356BC (E7,E6) (Trell, 1945)

In First Order Logic:

$E64(x) \Rightarrow E5(x)$

Properties:

P93 took out of existence (was taken out of existence by): E77 Persistent Item

E65 Creation

Subclass of:

[E7](#) Activity
[E63](#) Beginning of Existence

Superclass of:

[E83](#) Type Creation

Scope note:

This class comprises events that result in the creation of conceptual items or immaterial products, such as legends, poems, texts, music, images, movies, laws, types etc.

Examples:

- the framing of the U.S. Constitution (Farrand, 1913)
- the drafting of U.N. resolution 1441 (United Nations Security Council, 2002)

In First Order Logic:

$E65(x) \Rightarrow E7(x)$

$E65(x) \Rightarrow E63(x)$

Properties:

[P94](#) has created (was created by): [E28](#) Conceptual Object

E66 Formation

Subclass of:

[E7](#) Activity
[E63](#) Beginning of Existence

Scope note:

This class comprises events that result in the formation of a formal or informal [E74](#) Group of people, such as a club, society, association, corporation or nation.

E66 Formation does not include the arbitrary aggregation of people who do not act as a collective.

The formation of an instance of [E74](#) Group does not require that the group is populated with members at the time of formation. In order to express the joining of members at the time of formation, the respective activity should be simultaneously an instance of both E66 Formation and [E85](#) Joining.

Examples:

- the formation of the CIDOC CRM Special Interest Group in 2000
- the formation of the Soviet Union (Pipes, 1964)
- the conspiring of the murderers of Caesar (Irwin, 1935)

In First Order Logic:

$E66(x) \Rightarrow E7(x)$

$E66(x) \Rightarrow E63(x)$

Properties:

[P95](#) has formed (was formed by): [E74](#) Group

[P151](#) was formed from ([participated in](#)): [E74](#) Group

E67 Birth

Subclass of:

E63 Beginning of Existence

Scope note:

This class comprises the births of human beings. E67 Birth is a biological event focussing on the context of people coming into life. (E63 Beginning of Existence comprises the coming into life of any living being).

Twins, triplets etc. are typically brought into life by the same instance of E67 Birth. The introduction of E67 Birth as a documentation element allows the description of a range of family relationships in a simple model. Suitable extensions may describe more details and the complexity of motherhood with the intervention of modern medicine. In this model, the biological father is not seen as a necessary participant in the birth.

Examples:

- the birth of Alexander the Great (Stoneman, 2004)

In First Order Logic:

$E67(x) \Rightarrow E63(x)$

Properties:

P96 by mother (gave birth): E21 Person

P97 from father (was father for): E21 Person

P98 brought into life (was born): E21 Person

E68 Dissolution

Subclass of:

E64 End of Existence

Scope note:

This class comprises the events that result in the formal or informal termination of an instance of E74 Group.

If the dissolution was deliberate, the Dissolution event should also be instantiated as an instance of E7 Activity.

Examples:

- the fall of the Roman Empire (Whittington, 1964)
- the liquidation of Enron Corporation (Atlas, 2001)

In First Order Logic:

$E68(x) \Rightarrow E64(x)$

Properties:

P99 dissolved (was dissolved by): E74 Group

E69 Death

Subclass of:

E64 End of Existence

Scope note:

This class comprises the deaths of human beings.

If a person is *killed*, the death should be documented as an instance of both E69 Death and E7 Activity. The death or perishing of other living beings should be documented as instances of E64 End of Existence.

Examples:

- the murder of Julius Caesar (E69, E7) (Irwin, 1935)
- the death of Senator Paul Wellstone (Monast and Tao, 2002)

In First Order Logic:

$E69(x) \Rightarrow E64(x)$

Properties:

P100 was death of (died in): E21 Person

E70 Thing

Subclass of:

E77 Persistent Item

Superclass of:

E71 Human-Made Thing

E72 Legal Object

Scope note:

This general class comprises discrete, identifiable, instances of E77 Persistent Item that are documented as single units, that either consist of matter or depend on being carried by matter and are characterized by relative stability.

They may be intellectual products or physical things. They may for instance have a solid physical form, an electronic encoding, or they may be a logical concept or structure.

Examples:

- my photograph collection (E78) (fictitious)
- the bottle of milk in my refrigerator (E22) (fictitious)
- the Riss A1 plan of the Straßburger Münster (French: *Cathédrale Notre-Dame de Strasbourg*) (E29) (Liess, R., 1985)
- the thing on the top of Otto Hahn's desk (E19)
- the form of the no-smoking sign (E36)
- the cave of Dirou, Mani, Greece (E26) (Psimenos, 2005)

In First Order Logic:

$E70(x) \Rightarrow E77(x)$

Properties:

P43 has dimension (is dimension of): E54 Dimension

P101 had as general use (was use of): E55 Type

P130 shows features of (features are also found on): E70 Thing
(P130.1 kind of similarity: E55 Type)

E71 Human-Made Thing

Subclass of:

E70 Thing

Superclass of:

E24 Physical Human-Made Thing

E28 Conceptual Object

Scope note:

This class comprises discrete, identifiable human-made items that are documented as single units.

These items are either intellectual products or human-made physical things, and are characterized by relative stability. They may for instance have a solid physical form, an electronic encoding, or they may be logical concepts or structures.

Examples:

- Beethoven's 5th Symphony (E73) (Lockwood, 2015)
- Michelangelo's David (E22) (Paoletti and Bagemihl, 2015)
- Einstein's Theory of General Relativity (E89) (Hartle, 2003)
- the taxon '*Fringilla coelebs* Linnaeus, 1758' (E55) (Sinkevicius and Narusevicius, 2002)

In First Order Logic:

$E71(x) \Rightarrow E70(x)$

Properties:

P102 has title (is title of): E35 Title
(P102.1 has type: E55 Type)
P103 was intended for (was intention of): E55 Type

E72 Legal Object

Subclass of:

E70 Thing

Superclass of:

E18 Physical Thing
E90 Symbolic Object

Scope note:

This class comprises those material or immaterial items to which instances of E30 Right, such as the right of ownership or use, can be applied.

This is true for all instances of E18 Physical Thing. In the case of instances of E28 Conceptual Object, however, the identity of an instance of E28 Conceptual Object or the method of its use may be too ambiguous to reliably establish instances of E30 Right, as in the case of taxa and inspirations. Ownership of corporations is currently regarded as out of scope of the CIDOC CRM.

Examples:

- the Cullinan diamond (E19) (Scarratt and Shor, 2006)
- definition of the CIDOC Conceptual Reference Model Version 5.0.4 (E73) (ISO 21127: 2014)

In First Order Logic:

$E72(x) \Rightarrow E70(x)$

Properties:

P104 is subject to (applies to): E30 Right
P105 right held by (has right on): E39 Actor

E73 Information Object

Subclass of:

E89 Propositional Object

E90 Symbolic Object

Superclass of:

E29 Design or Procedure
E31 Document
E33 Linguistic Object
E36 Visual Item

Scope note:

This class comprises identifiable immaterial items, such as poems, jokes, data sets, images, texts, multimedia objects, procedural prescriptions, computer program code, algorithm or mathematical formulae, that have an objectively recognizable structure and are documented as single units. The encoding structure known as a "named graph" also falls under this class, so that each "named graph" is an instance of E73 Information Object.

An instance of E73 Information Object does not depend on a specific physical carrier, which can include human memory, and it can exist on one or more carriers simultaneously.

Instances of E73 Information Object of a linguistic nature should be declared as instances of the E33 Linguistic Object subclass. Instances of E73 Information Object of a documentary nature should be declared as instances of the E31 Document subclass. Conceptual items such as types and classes are not instances of E73 Information Object, nor are ideas without a reproducible expression.

Examples:

- image BM000038850.JPG from the Clayton Herbarium in London (E31) (Natural History Museum, 2021)
- E. A. Poe's "The Raven" (Poe, 1869)
- the movie "The Seven Samurai" by Akira Kurosawa (Mellen, 2002)
- the text of Huray describing the Maxwell Equations (Huray, 2010)
- the Getty AAT as published as Linked Open Data, accessed 1/10/2014

In First Order Logic:

$E73(x) \Rightarrow E89(x)$

$E73(x) \Rightarrow E90(x)$

Properties:

P165 incorporates (is incorporated in): E90 Symbolic Object

E74 Group

Subclass of:

E39 Actor

Scope note:

This class comprises any gatherings or organizations of human individuals or groups that act collectively or in a similar way due to any form of unifying relationship. In the wider sense this class also comprises official positions which used to be regarded in certain contexts as one actor, independent of the current holder of the office, such as the president of a country. In such cases, it may happen that the group never had more than one member. A joint pseudonym (i.e., a name that seems indicative of an individual but that is actually used as a persona by two or more people) is a particular case of E74 Group.

A gathering of people becomes an instance of E74 Group when it exhibits organizational characteristics usually typified by a set of ideas or beliefs held in common, or actions performed together. These might be communication, creating some common artifact, a

common purpose such as study, worship, business, sports, etc. Nationality can be modelled as membership in an instance of E74 Group. Married couples and other concepts of family are regarded as particular examples of E74 Group.

Examples:

- the impressionists (Wilson, 1994)
- the Navajo (Correll, 1972)
- the Greeks (Williams, 1993)
- the peace protestors in New York City on 15th February 2003
- Exxon-Mobil (Raymond, 2006)
- King Solomon and his wives (Thieberger, 1947)
- the President of the Swiss Confederation
- Nicolas Bourbaki [the collective pseudonym of a group of mathematicians, predominantly French alumni of the École normale supérieure] (Aczel, 2007)
- Betty Crocker (Crocker, 2012)
- Ellery Queen [Ellery Queen is a pseudonym created in 1929 by American crime fiction writers Frederic Dannay and Manfred Bennington Lee.] (Wheat, 2005)
- Greenpeace
- Paveprime Ltd
- the National Museum of Denmark

In First Order Logic:

$E74(x) \Rightarrow E39(x)$

Properties:

P107 has current or former member (is current or former member of): E39 Actor
(P107.1 kind of member: E55 Type)

E77 Persistent Item

Subclass of:

E1 CRM Entity

Superclass of:

E39 Actor

E70 Thing

Scope note:

This class comprises items that have persistent characteristics of structural nature substantially related to their identity and their integrity, sometimes known as “endurants” in philosophy. Persistent Items may be physical entities, such as people, animals or things, conceptual entities such as ideas, concepts, products of the imagination or even names.

Instances of E77 Persistent Item may be present or be part of interactions in different periods or events. They can repeatedly be recognized at disparate occasions during their existence by characteristics of structural nature. The respective characteristics need not be exactly the same during all the existence of an instance of E77 Persistent Item. Often, they undergo gradual change, still bearing some similarities with that of previous times, or disappear completely and new emerge. For instance, a person, from the time of being born on, will gradually change all its features and acquire new ones, such as a scar. Even the DNA in different body cells will develop defects and mutations. Nevertheless, relevant characteristics use to be sufficiently similar to recognize the instance for some substantial period of time.

The more specific criteria that determine the identity of instances of subclasses of E77 Persistent Item may vary considerably and are described ~~of~~or referred to in the respective

scope notes. The decision about which exact criteria to use depends on whether the observable behaviour of the respective part of reality such confined conforms to the reasoning the user is interested in. For example, a building can be regarded as no longer existing if it is dismantled and the materials reused in a different configuration. On the other hand, human beings go through radical and profound changes during their life-span, affecting both material composition and form, yet preserve their identity by other criteria, such as being bodily separated from other persons. Similarly, inanimate objects may be subject to exchange of parts and matter. On the opposite, the identity of a (version of a) text of a scientific publication is given by the exact arrangement of its relevant symbols.

The main classes of objects that fall outside the scope of the E77 Persistent Item class are temporal objects such as periods, events and acts, and descriptive properties.

An instance of E77 Persistent Item does not require actual knowledge of the identifying features of the instance being currently known. There may be cases, where the actual identifying features of an instance of E77 Persistent Item are not decidable at a particular state of knowledge.

Examples:

- Leonard da Vinci (E21) (Strano, 1953)
- Stonehenge (E24) (Pryor, 2016)
- the hole in the ozone layer (E4) (Hufford and Horwitz, 2005)
- the First Law of Thermodynamics (E89) (Craig and Gislason, 2002)
- the Bermuda Triangle (E53) (Dolan, 2005)

In First Order Logic:

$E77(x) \Rightarrow E1(x)$

E78 Curated Holding

Subclass of:

E24 Physical Human-Made Thing

Scope note:

This class comprises aggregations of instances of E18 Physical Thing that are assembled and maintained (“curated” and “preserved,” in museological terminology) by one or more instances of E39 Actor over time for a specific purpose and audience, and according to a particular collection development plan. Typical instances of curated holdings are museum collections, archives, library holdings and digital libraries. A digital library is regarded as an instance of E18 Physical Thing because it requires keeping physical carriers of the electronic content.

Items may be added or removed from an E78 Curated Holding in pursuit of this plan. This class should not be confused with the E39 Actor maintaining the E78 Curated Holding often referred to with the name of the E78 Curated Holding (e.g., “The Wallace Collection decided...”).

Collective objects in the general sense, like a tomb full of gifts, a folder with stamps or a set of chessmen, should be documented as instances of E19 Physical Object, and not as instances of E78 Curated Holding. This is because they form wholes either because they are physically bound together or because they are kept together for their functionality.

Examples:

- the John Clayton Herbarium (Blake, 1918), (Natural History Museum, 2021)
- the Wallace Collection (Ingamells, 1990)

- Mikael Heggelund Foslie's coralline red algae Herbarium at Museum of Natural History and Archaeology, Trondheim, Norway (Woelkerling et al., 2005)
- the Digital Collections of the Munich Digitization Center (MDZ) accessible via <https://www.digitale-sammlungen.de/> at least in January 2018.

In First Order Logic:

$E78(x) \Rightarrow E24(x)$

Properties:

P109 has current or former curator (is current or former curator of): E39 Actor

E79 Part Addition

Subclass of:

E11 Modification

Scope note:

This class comprises activities that result in an instance of E24-E18 Physical ~~Human-Made~~ Thing being increased, enlarged or augmented by the addition of a part.

Typical scenarios include the attachment of an accessory, the integration of a component, the addition of an element to an aggregate object, or the accessioning of an object into a curated instance of E78 Curated Holding. Objects to which parts are added are, by definition, human-made, since the addition of a part implies a human activity. Following the addition of parts, the resulting human-made assemblages are treated objectively as single identifiable wholes, made up of constituent or component parts bound together either physically (for example the engine becoming a part of the car), or by sharing a common purpose (such as the 32 chess pieces that make up a chess set). This class of activities forms a basis for reasoning about the history and continuity of identity of objects that are integrated into other objects over time, such as precious gemstones being repeatedly incorporated into different items of jewellery, or cultural artifacts being added to different museum instances of E78 Curated Holding over their lifespan.

Examples:

- the setting of the Koh-I-Noor diamond into the crown of Queen Elizabeth the Queen Mother (Dalrymple, 2017)
- the addition of the painting "Room in Brooklyn" by Edward Hopper to the collection of the Museum of Fine Arts, Boston
- [the attachment of the bronze hand on the tree forming the Alpi Marittime](https://giuseppenone.com/en/words/maritime-alps) (<https://giuseppenone.com/en/words/maritime-alps>) ([PennoneMangini, 19682010](https://giuseppenone.com/en/words/maritime-alps))

In First Order Logic:

$E79(x) \Rightarrow E11(x)$

Properties:

P110 augmented (was augmented by): E24-E18 Physical ~~Human-Made~~ Thing
P111 added (was added by): E18 Physical Thing

E80 Part Removal

Subclass of:

[E11](#) Modification

Scope note:

This class comprises the activities that result in an instance of E18 Physical Thing being decreased by the removal of a part.

Typical scenarios include the detachment of an accessory, the removal of a component or part of a composite object, or the deaccessioning of an object from a curated collection, an instance of E78 Curated Holding. If the instance of E80 Part Removal results in the total decomposition of the original object into pieces, such that the whole ceases to exist, the activity should instead be modelled as an instance of E81 Transformation, i.e., a simultaneous destruction and production. In cases where the part removed has no discernible identity prior to its removal but does have an identity subsequent to its removal, the activity should be modelled as both an instance of E80 Part Removal and E12 Production. This class of activities forms a basis for reasoning about the history, and continuity of identity over time, of objects that are removed from other objects, such as precious gemstones being extracted from different items of jewellery, or cultural artifacts being deaccessioned from different museum collections over their lifespan.

Examples:

- [the removal of the Porite coral specimen from the Cocos Islands by Charles Darwin in April 1836 \(Natural History Museum, 2021, b\)](#)
- the removal of the engine from my car (fictitious)
- the disposal of object number 1976:234 from the collection (fictitious)

In First Order Logic:

$E80(x) \Rightarrow E11(x)$

Properties:

[P112](#) diminished (was diminished by): [E24](#) ~~E18 Physical Human-Made-Thing~~
[P113](#) removed (was removed by): [E18](#) Physical Thing

E81 Transformation

Subclass of:

[E63](#) Beginning of Existence
[E64](#) End of Existence

Scope note:

This class comprises the events that result in the simultaneous destruction of one or more than one E18 Physical Thing and the creation of one or more than one E18 Physical Thing that preserves recognizable substance and structure from the first one(s) but has fundamentally different nature or identity.

Although the old and the new instances of E18 Physical Thing are treated as discrete entities having separate, unique identities, they are causally connected through the E81 Transformation; the destruction of the old E18 Physical Thing(s) directly causes the creation of the new one(s) using or preserving some relevant substance and structure. Instances of E81 Transformation are therefore distinct from re-classifications (documented using E17 Type Assignment) or modifications (documented using E11 Modification) of objects that do not fundamentally change their nature or identity. Characteristic cases are reconstructions and

repurposing of historical buildings or ruins, fires leaving buildings in ruins, taxidermy of specimen in natural history.

Even though such instances of E81 Transformation are often motivated by a change of intended use, substantial material changes should justify the documentation of the result as a new instance of E18 Physical Thing and not just the change of function. The latter may be documented as an extended activity (instance of E7 Activity) of using it.

Examples:

- the mummification of Tut-Ankh-Amun (E81, E12) [the mummification of the body of the deceased is a human production process and simultaneously preserves structures of the body at and before death] (Carter and Mace 1977)
- the death, carbonization and petrification of some people of Pompeii in 79AD by the intense heat of a pyroclastic cloud and ashes from the Eruption of Mount Vesuvius (E69, E81)
- the transformation of the *Hephaisteion* temple in Athens, better known as "Theseion", into a Christian church, dedicated to Saint George around AD 700 (E81,E12) [which actually helped preserving part of the antique temple structure from 449BC]

In First Order Logic:

$E81(x) \Rightarrow E63(x)$

$E81(x) \Rightarrow E64(x)$

Properties:

P123 resulted in (resulted from): E18 Physical Thing

P124 transformed (was transformed by): E18 Physical Thing

E83 Type Creation

Subclass of:

E65 Creation

Scope note:

This class comprises activities formally defining new types of items.

It is typically a rigorous scholarly or scientific process that ensures a type is exhaustively described and appropriately named. In some cases, particularly in archaeology and the life sciences, E83 Type Creation requires the identification of an exemplary specimen and the publication of the type definition in an appropriate scholarly forum. The activity modelled as an instance of E83 Type Creation is central to research in the life sciences, where a type would be referred to as a "taxon," the type description as a "protologue," and the exemplary specimens as "original element" or "holotype".

Examples:

- creation of the taxon '*Penicillium brefeldianum*' (Dodge, 1933)
- addition of class E85 Joining to the CIDOC CRM

In First Order Logic:

$E83(x) \Rightarrow E65(x)$

Properties:

P135 created type (was created by): E55 Type

P136 was based on (supported type creation): E1 CRM Entity

(P136.1 in the taxonomic role: E55 Type)

E85 Joining

Subclass of:

E7 Activity

Scope note:

This class comprises the activities that result in an instance of E39 Actor becoming a member of an instance of E74 Group. This class does not imply initiative by either party. It may be the initiative of a third party.

Typical scenarios include becoming a member of a social organisation, becoming employee of a company, marriage, the adoption of a child by a family and the inauguration of somebody into an official position.

Examples:

- the election of Sir Isaac Newton as Member of Parliament for the University of Cambridge to the Convention Parliament of 1689 (Gleick, 2003)
- the inauguration of Mikhail Sergeyeovich Gorbachev as leader of the Union of Soviet Socialist Republics (USSR) in 1985 (Butson, 1986)
- the implementation of the membership treaty between EU and Denmark, 1st January 1993

In First Order Logic:

$E85(x) \Rightarrow E7(x)$

Properties:

P143 joined (was joined by): E39 Actor
P144 joined with (gained member by) E74 Group
(P144.1 kind of member: E55 Type)

E86 Leaving

Subclass of:

E7 Activity

Scope note:

This class comprises the activities that result in an instance of E39 Actor to be disassociated from an instance of E74 Group. This class does not imply initiative by either party. It may be the initiative of a third party.

Typical scenarios include the termination of membership in a social organisation, ending the employment at a company, divorce, and the end of tenure of somebody in an official position.

Examples:

- the end of Sir Isaac Newton's duty as Member of Parliament for the University of Cambridge to the Convention Parliament in 1702 (Gleick, 2003)
- George Washington's leaving office in 1797 (Jones, 1979)
- the implementation of the treaty regulating the termination of Greenland's membership in EU between EU, Denmark and Greenland February 1st 1985

In First Order Logic:

$E86(x) \Rightarrow E7(x)$

Properties:

P145 separated (left by) E39 Actor
P146 separated from (lost member by) E74 Group

E87 Curation Activity

Subclass of:

E7 Activity

Scope note:

This class comprises the activities that result in the continuity of management and the preservation and evolution of instances of E78 Curated Holding, following an implicit or explicit curation plan.

It specializes the notion of activity into the curation of a collection and allows the history of curation to be recorded.

Items are accumulated and organized following criteria like subject, chronological period, material type, style of art etc. and can be added or removed from an instance of E78 Curated Holding for a specific purpose and/or audience. The initial aggregation of items of a collection is regarded as an instance of E12 Production Event while the activity of evolving, preserving and promoting a collection is regarded as an instance of E87 Curation Activity.

Examples:

- the curation of Mikael Heggelund Foslie's coralline red algae Herbarium 1876 – 1909 (when Foslie died), now at Museum of Natural History and Archaeology, Norway (Woelkerling et al., 2005)

In First Order Logic:

$E87(x) \Rightarrow E7(x)$

Properties:

P147 curated (was curated by): E78 Curated Holding

E89 Propositional Object

Subclass of:

E28 Conceptual Object

Superclass of:

E73 Information Object

E30 Right

Scope note:

This class comprises immaterial items, including but not limited to stories, plots, procedural prescriptions, algorithms, laws of physics or images that are, or represent in some sense, sets of propositions about real or imaginary things and that are documented as single units or serve as topic of discourse.

This class also comprises items that are “about” something in the sense of a subject. In the wider sense, this class includes expressions of psychological value such as non-figural art and musical themes. However, conceptual items such as types and classes are not instances of E89 Propositional Object. This should not be confused with the definition of a type, which is indeed an instance of E89 Propositional Object.

Examples:

- Maxwell's Equations (Ball, 1962)
- the ideational contents of Aristotle's book entitled 'Metaphysics' as rendered in the Greek texts translated in Oxford edition
- the underlying prototype of any “no-smoking” sign (E36)

- the common ideas of the plots of the movie "The Seven Samurai" by Akira Kurosawa and the movie "The Magnificent Seven" by John Sturges (Mellen, 2002)
- the image content of the photo of the Allied Leaders at Yalta published by UPI, 1945 (E36)
- the character "Little Red Riding Hood", variants of which appear amongst others in Grimm brothers' 'Rotkäppchen', other oral fairy tales and the film 'Hoodwinked'
- the place "Havnor" as invented by Ursula K. Le Guin for her 'Earthsea' book series, the related maps and appearing in derivative works based on these novels

In First Order Logic:

$E89(x) \Rightarrow E28(x)$

Properties:

P148 has component (is component of): E89 Propositional Object

P67 refers to (is referred to by): E1 CRM Entity

(P67.1 has type: E55 Type)

P129 is about (is subject of): E1 CRM Entity

E90 Symbolic Object

Subclass of:

E28 Conceptual Object

E72 Legal Object

Superclass of:

E73 Information Object

E41 Appellation

Scope note:

This class comprises identifiable symbols and any aggregation of symbols, such as characters, identifiers, traffic signs, emblems, texts, data sets, images, musical scores, multimedia objects, computer program code or mathematical formulae that have an objectively recognizable structure and that are documented as single units.

It includes sets of signs of any nature, which may serve to designate something, or to communicate some propositional content. An instance of E90 Symbolic Object may or may not have a specific meaning, for example an arbitrary character string.

In some cases, the content of an instance of E90 Symbolic Object may completely be represented by a serialized digital content model, such as a sequence of ASCII-encoded characters, an XML or HTML document, or a TIFF image. The property *P3 has note* and its subproperty *P190 has symbolic content* allow for the description of this content model. In order to disambiguate which symbolic level is the carrier of the meaning, the property *P3.1 has type* can be used to specify the encoding (e.g., "bit", "Latin character", RGB pixel).

Examples:

- 'ecognizabl'
- the "no-smoking" sign (E36)
- "BM000038850.JPG" (E41) [identifies a digital image] (Natural History Museum, 2021)
- image BM000038850.JPG from the Clayton Herbarium in London (E36) [depicts specimen of *Verbesina virginica*] (Natural History Museum, 2021)
- the distribution of form, tone and colour found on Leonardo da Vinci's painting named "Mona Lisa" in daylight (E36)
- the Italian text of Dante's "Divina Commedia" as found in the authoritative critical edition *La Commedia secondo l'antica vulgata a cura di Giorgio Petrocchi*, Milano: Mondadori, 1966-

67 (= Le Opere di Dante Alighieri, Edizione Nazionale a cura della Società Dantesca Italiana, VII, 1-4) (Petrocchi, 1967) (E33)

In First Order Logic:

$E90(x) \Rightarrow E28(x)$

$E90(x) \Rightarrow E72(x)$

Properties:

P106 is composed of (forms part of): E90 Symbolic Object

P190 has symbolic content: E62 String

E92 Spacetime Volume

Subclass of:

E1 CRM Entity

Superclass of:

E4 Period

E93 Presence

Scope note:

This class comprises 4-dimensional point sets (volumes) in physical spacetime (in contrast to mathematical models of it) regardless their true geometric forms. They may derive their identity from being the extent of a material phenomenon or from being the interpretation of an expression defining an extent in spacetime. Intersections of instances of E92 Spacetime Volume, E53 Place and E52 Time-Span are also regarded as instances of E92 Spacetime Volume. An instance of E92 Spacetime Volume is either contiguous or composed of a finite number of contiguous subsets. Its boundaries may be fuzzy due to the properties of the phenomena it derives from or due to the limited precision up to which defining expression can be identified with a real extent in spacetime. The duration of existence of an instance of E92 Spacetime Volume is its projection on time.

Examples:

- the extent in space and time of the Event of Caesar's murder (Irwin, 1935)
- where and when the carbon 14 dating of the "Schoeninger Speer II" in 1996 took place (Kouwenhoven, 1997)
- the spatio-temporal trajectory of the H.M.S. Victory from its building to its actual location (Goodwin, 2015)
- the extent in space and time defined by a polygon approximating the Danube river flood in Austria between 6th and 9th of August 2002

In First Order Logic:

$E92(x) \Rightarrow E1(x)$

Properties:

P10 falls within (contains): E92 Spacetime Volume

P132 spatiotemporally overlaps with: E92 Spacetime Volume

P133 spatiotemporally separated from: E92 Spacetime Volume

P160 has temporal projection (is temporal projection of): E52 Time-Span

P161 has spatial projection (is spatial projection of): E53 Place

E93 Presence

Subclass of:

[E92 Spacetime Volume](#)

Scope note:

This class comprises instances of [E92 Spacetime Volume](#), whose temporal extent has been chosen in order to determine the spatial extent of a phenomenon over the chosen time-span. Respective phenomena may, for instance, be historical events or periods, but can also be the diachronic extent and existence of physical things. In other words, instances of this class fix a slice of another instance of [E92 Spacetime Volume](#) in time.

The temporal extent of an instance of [E93 Presence](#) typically is predetermined by the researcher so as to focus the investigation particularly on finding the spatial extent of the phenomenon by testing for its characteristic features. There are at least two basic directions such investigations might take. The investigation may wish to determine where something was during some time or it may wish to reconstruct the total passage of a phenomenon's spacetime volume through an examination of discrete presences. Observation and measurement of features indicating the presence or absence of a phenomenon in some space allows for the progressive approximation of spatial extents through argumentation typically based on inclusion, exclusion and various overlaps.

Examples:

- the Roman Empire on 19 August AD 14 (Clare and Edwards, 1992)
- Johann Joachim Winckelmann's whereabouts in December 1775 (Leppmann, 1970)
- Johann Joachim Winckelmann's whereabouts from November 19 1755 until April 9 1768 (Leppmann, 1970)

In First Order Logic:

$E93(x) \Rightarrow E92(x)$

Properties:

[P164](#) is temporally specified by (temporally specifies): [E52 Time-Span](#)

[P166](#) was a presence of (had presence): [E92 Spacetime Volume](#)

[P167](#) was within (includes): [E53 Place](#)

[P195](#) was a presence of (had presence): [E18 Physical Thing](#)

[P197](#) covered parts of (was partially covered by): [E53 Place](#)

E94 Space Primitive

Subclass of:

[E41 Appellation](#)

[E59 Primitive Value](#)

Scope Note:

This class comprises instances of [E59 Primitive Value](#) for space that should be implemented with appropriate validation, precision and references to spatial coordinate systems to express geometries on or relative to Earth, or on any other stable constellations of matter, relevant to cultural and scientific documentation.

An instance of [E94 Space Primitive](#) defines an instance of [E53 Place](#) in the sense of a declarative place as elaborated in CRMgeo (Doerr & Hiebel 2013), which means that the identity of the place is derived from its geometric definition. Such a declarative place may allow for the approximation of instances of [E53 Place](#) defined by the actual extent of some

phenomenon, such as a settlement or a riverbed, or other forms of identification rather than by an instance of E94 Space Primitive. Note that using an instance of E94 Space Primitive for approximating the actual extent of some place always defines a (declarative) instance of E53 Place in its own right.

Definitions of instances of E53 Place using different spatial reference systems are always definitions of different instances of E53 Place.

Instances of E94 Space Primitive provide the ability to link CIDOC CRM encoded data to the kinds of geometries used in maps or Geoinformation systems. They may be used for visualization of the instances of E53 Place they define, in their geographic context and for computing topological relations between places based on these geometries. E94 Space Primitive is not further elaborated upon within this model. It is considered good practice to maintain compatibility with OGC standards.

Examples:

- `<gml:Point gml:id="p21" srsName="http://www.opengis.net/def/crs/EPSG/0/4326">
<gml:coordinates>45.67, 88.56</gml:coordinates> </gml:Point>` [Coordinate Information in GML]
- “40°31'17.9"N 21°15'48.3"E” [A single point for approximating the centre of the city of Kastoria, Greece]
- POLYGON ((30 10, 40 40, 20 40, 10 20, 30 10)) [Well-Known Text (WKT)]

In First Order Logic:

$E94(x) \Rightarrow E41(x)$

$E94(x) \Rightarrow E59(x)$

E95 Spacetime Primitive

Subclass of:

E41 Appellation

E59 Primitive Value

Scope Note:

This class comprises instances of E59 Primitive Value for spacetime volumes that should be implemented with appropriate validation, precision and reference systems to express geometries being limited and varying over time on or relative to Earth, or any other stable constellations of matter, relevant to cultural and scientific documentation. An instance of E95 Spacetime Primitive may consist of one expression including temporal and spatial information such as in GML or a different form of expressing spacetime in an integrated way such as a formula containing all 4 dimensions.

An instance of E95 Spacetime Primitive defines an instance of E92 Spacetime Volume in the sense of a declarative spacetime volume as defined in CRMgeo (Doerr & Hiebel 2013), which means that the identity of the instance of E92 Spacetime Volume is derived from its geometric and temporal definition. This declarative spacetime volume allows for the application of all E92 Spacetime Volume properties to relate phenomenal spacetime volumes of periods and physical things to propositions about their spatial and temporal extents.

Instances of E92 Spacetime Volume defined by P169 defines spacetime volume (spacetime volume is defined by) that use different spatiotemporal referring systems are always regarded as different instances of the E92 Spacetime Volume.

It is possible for a spacetime volume to be defined by phenomena causal to it, such as an expanding and declining realm, a settlement structure or a battle, or other forms of identification rather than by an instance of E95 Spacetime Primitive. Any spatiotemporal

approximation of such a phenomenon by an instance of E95 Spacetime Primitive constitutes an instance of E92 Spacetime Volume in its own right.

E95 Spacetime Primitive is not further elaborated upon within this model. Compatibility with OGC standards is recommended.

Examples:

```
• <Placemark>
  <name> Byzantine Empire </name><styleUrl>#style_1</styleUrl>
  <TimeSpan>
    <begin>330</begin><end>1453</end>
  </TimeSpan>
  <Polygon>
    <altitudeMode>clampToGround</altitudeMode>
    <outerBoundaryIs>
      <LinearRing>
        <coordinates>18.452787460,40.85553626,0
          17.2223187,40.589098,....0 17.2223,39.783
        </coordinates>
      </LinearRing>
    </outerBoundaryIs>
  </Polygon>
</Placemark>
[spatial and temporal information in KML for the maximum extent of the Byzantine Empire]
```

In First Order Logic:

```
E95(x) ⇒ E41(x)
E95(x) ⇒ E59(x)
```

Properties:

P169 defines spacetime volume (spacetime volume is defined by): E92 Spacetime Volume

E96 Purchase

Subclass of:

E8 Acquisition

Scope note:

This class comprises transfers of legal ownership from one or more instances of E39 Actor to one or more different instances of E39 Actor, where the transferring party is completely compensated by the payment of a monetary amount. In more detail, a purchase agreement establishes a fixed monetary obligation at its initialization on the receiving party, to the giving party. An instance of E96 Purchase begins with the contract or equivalent agreement and ends with the fulfilment of all contractual obligations. In the case that the activity is abandoned before both parties have fulfilled these obligations, the activity is not regarded as an instance of E96 Purchase.

This class is a very specific case of the much more complex social business practices of exchange of goods and the creation and satisfaction of related social obligations. Purchase activities which define individual sales prices per object can be modelled by instantiating E96 Purchase for each object individually and as part of an overall instance of E96 Purchase transaction.

Examples:

- the purchase of 10 okka of nails by the captain A. Syrmas on 18th September 1895 in Thessaloniki (Syrmas, 1896)

In First Order Logic:

$E96(x) \Rightarrow E8(x)$

Properties:

P179 had sales price (was sales price of): E97 Monetary Amount

E97 Monetary Amount

Subclass of:

E54 Dimension

Scope note:

This class comprises quantities of monetary possessions or obligations in terms of their nominal value with respect to a particular currency. These quantities may be abstract accounting units, the nominal value of a heap of coins or bank notes at the time of validity of the respective currency, the nominal value of a bill of exchange or other documents expressing monetary claims or obligations. It specifically excludes amounts expressed in terms of weights of valuable items, like gold and diamonds, and quantities of other non-currency items, like goats or stocks and bonds.

Example:

- Christies' hammer price for Vincent van Gogh's "Still Life: Vase with Fifteen Sunflowers" in London on 30th March 1987

In First Order Logic:

$E97(x) \Rightarrow E54(x)$

Properties:

P180 has currency (was currency of): E98 Currency

E98 Currency

Subclass of:

E58 Measurement Unit

Scope note:

This class comprises the units in which a monetary system, supported by an administrative authority or other community, quantifies and arithmetically compares all monetary amounts declared in the unit. The unit of a monetary system must describe a nominal value which is kept constant by its administrative authority and an associated banking system if it exists, and not by market value. For instance, one may pay with grams of gold, but the respective monetary amount would have been agreed as the gold price in US dollars on the day of the payment. Under this definition, British Pounds, U.S. Dollars, and European Euros are examples of currency, but "grams of gold" is not. One monetary system has one and only one currency. Instances of this class must not be confused with coin denominations, such as "Dime" or "Sestertius". Non-monetary exchange of value in terms of quantities of a particular type of goods, such as cows, do not constitute a currency.

Examples:

- "As" [Roman mid republic]
- "Euro", (Temperton, 1997)
- "US Dollar" (Rose, 1978)

In First Order Logic:

$E98(x) \Rightarrow E58(x)$

E99 Product Type

Subclass of:

E55 Type

Scope note:

This class comprises types that stand as the models for instances of E22 Human-Made Object that are produced as the result of production activities using plans exact enough to result in one or more series of uniform, functionally and aesthetically identical and interchangeable items. The product type is the intended ideal form of the manufacture process. It is typical of instances of E22 that conform to an instance of E99 Product Type that its component parts are interchangeable with component parts of other instances of E22 made after the model of the same instance of E99. Frequently, the uniform production according to a given instance of E99 Product Type is achieved by creating individual tools, such as moulds or print plates that are themselves carriers of the design of the product type. Modern tools may use the flexibility of electronically controlled devices to achieve such uniformity. The product type itself, i.e., the potentially unlimited series of aesthetically equivalent items, may be the target of artistic design, rather than the individual object. In extreme cases, only one instance of a product type may have been produced, such as in a "print on demand" process which was only triggered once. However, this should not be confused with industrial prototypes, such as car prototypes, which are produced prior to the production line being set up, or test the production line itself.

Examples:

- Volkswagen Type 11 (Beetle) (Rieger, 2013)
- Dragendorff 54 samian vessel
- 1937 Edward VIII brass threepenny bit
- Qin Crossbow trigger un-notched Part B (Bg2u) (Li, 2012)
- Nokia Cityman 1320 [The first Nokia mobile phone]

In First Order Logic:

$E99(x) \Rightarrow E55(x)$

Properties:

P187 has production plan (is production plan for): E29 Design or Procedure
P188 requires production tool (is production tool for): E19 Physical Object

CIDOC CRM Property Declarations

The properties of the CIDOC CRM are comprehensively declared in this section using the following format:

- Property names are presented as headings in bold face, preceded by unique property identifiers;
- The line “Domain:” declares the class for which the property is defined;
- The line “Range:” declares the class to which the property points, or that provides the values for the property;
- The line “Superproperty of:” is a cross-reference to any subproperties the property may have;
- The line “Quantification:” declares the possible number of occurrences for domain and range class instances for the property. Possible values are: 1:many, many:many, many:1;
- The line “Scope note:” contains the textual definition of the concept the property represents;
- The line “Examples:” contains a bulleted list of examples of instances of this property. If the example is also instance of a subproperty of this property, the unique identifier of the subclass is added in parenthesis. If the example instantiates two properties, the unique identifiers of both properties is added in parenthesis.
The line “Examples:” provides illustrative examples showing how the property should be used.

P1 is identified by (identifies)

Domain:

E1 CRM Entity

Range:

E41 Appellation

Superproperty of:

E1 CRM Entity. P48 has preferred identifier (is preferred identifier of): E42 Identifier
E71 Human-Made Thing. P102 has title (is title of): E35 Title
E53 Place. P168 place is defined by (defines place): E94 Space Primitive
E95 Spacetime Primitive. P169i spacetime volume is defined by: E92 Spacetime Volume
E61 Time Primitive. P170i time is defined by: E52 Time_Span

Quantification:

many to many (0,n:0,n)

Scope note:

This property describes the naming or identification of any real-world item by a name or any other identifier.

This property is intended for identifiers in general use, which form part of the world the model intends to describe, and not merely for internal database identifiers which are specific to a technical system, unless these latter also have a more general use outside the technical context. This property includes in particular identification by mathematical expressions such as coordinate systems used for the identification of instances of E53 Place. The property does not reveal anything about when, where and by whom this identifier was used. A more detailed representation can be made using the fully developed (i.e., indirect) path through E15 Identifier Assignment.

This property is a shortcut for the path from E1 CRM Entity through *P140i was attributed by*, E15 Identifier Assignment, *P37 assigned to* E42 Identifier.

It is also a shortcut for the path from E1 CRM Entity through *P1 is identified by*, E41 Appellation, *P139 has alternative form to* E41 Appellation.

Examples:

- The capital of Italy (E53) *is identified by* “Rome” (E41). (Leach, 2017)
- Text 25014–32 (E33) *is identified by* “The Decline and Fall of the Roman Empire” (E35). (Gibbon, 2013)

In First Order Logic:

$P1(x,y) \Rightarrow E1(x)$

$P1(x,y) \Rightarrow E41(y)$

$P1(x,y) \Leftarrow (\exists z) [E15(z) \wedge P140i(x,z) \wedge P37(z,y)]$

$P1(x,y) \Leftarrow (\exists z) [E41(z) \wedge P1(x,z) \wedge P139(z,y)]$

P2 has type (is type of)

Domain:

E1 CRM Entity

Range:

E55 Type

Superproperty of:

E1 CRM Entity, P137 exemplifies (is exemplified by): E55 Type
E13 Attribute Assignment, P177 assigned property of type: E55 Type

Quantification:

many to many (0,n:0,n)

Scope note:

This property allows sub typing of CIDOC CRM entities –a form of specialisation – through the use of a terminological hierarchy, or thesaurus.

The CIDOC CRM is intended to focus on the high-level entities and relationships needed to describe data structures. Consequently, it does not specialise entities any further than is required for this immediate purpose. However, entities in the isA hierarchy of the CIDOC CRM may be specialised into any number of sub entities, which can be defined in the E55 Type hierarchy. E41 Appellation, for example, may be specialised into “e-mail address”, “telephone number”, “post office box”, “URL” etc. none of which figures explicitly in the CIDOC CRM hierarchy. A comprehensive explanation about refining CIDOC CRM concepts by E55 Type is given in the section “About Types” in the section on “Specific Modelling Constructs” of this document.

This property is a shortcut for the path from E1 CRM Entity through *P41i was classified by*, E17 Type Assignment, *P42 assigned to* E55 Type.

Examples:

- “enquiries@cidoc-crm.org” (E41) *has type* e-mail address (E55). (fictitious)

In First Order Logic:

$P2(x,y) \Rightarrow E1(x)$

$P2(x,y) \Rightarrow E55(y)$

$P2(x,y) \Leftarrow (\exists z) [E17(z)] \wedge P41i(x,z) \wedge P42(z,y)$

P3 has note

Domain:

E1 CRM Entity

Range:

E62 String

Superproperty of:

E52 Time-Span. P79 beginning is qualified by: E62 String

E52 Time-Span. P80 end is qualified by: E62 String

E90 Symbolic Object. P190 has symbolic content: E62 String

Quantification:

one to many (0,n:0,1)

Scope note:

This property is a container for all informal descriptions about an object that have not been expressed in terms of CIDOC CRM constructs.

In particular, it captures the characterisation of the item itself, its internal structures, appearance etc.

Like property *P2 has type (is type of)*, this property is a consequence of the restricted focus of the CIDOC CRM. The aim is not to capture, in a structured form, everything that can be said about an item; indeed, the CIDOC CRM formalism is not regarded as sufficient to express everything that can be said. Good practice requires use of distinct note fields for different aspects of a characterisation. The *P3.1 has type* property of *P3 has note* allows differentiation of specific notes, e.g., “construction”, “decoration” etc.

An item may have many notes, but a note is attached to a specific item.

Examples:

- Coffee mug – OXCMS:1983.1.1 (E19) *has note* “chipped at edge of handle” (E62) *has type* Condition (E55). (fictitious)

In First Order Logic:

$P3(x,y) \Rightarrow E1(x)$

$P3(x,y) \Rightarrow E62(y)$

$P3(x,y,z) \Rightarrow [P3(x,y) \wedge E55(z)]$

Properties:

P3.1 has type: E55 Type

P4 has time-span (is time-span of)

Domain:

E2 Temporal Entity

Range:

E52 Time-Span

Quantification:

many to one, necessary (1,1:0,n)

Scope note:

This property associates an instance of E2 Temporal Entity with the instance of E52 Time-Span during which it was on-going. The associated instance of E52 Time-Span is understood as the real time-span during which the phenomena making up the temporal entity instance were active. More than one instance of E2 Temporal Entity may share a common instance of E52 Time-Span only if they come into being and end being due to identical declarations or events.

Examples:

- The Yalta Conference (E7) *has time-span* Yalta Conference time-span (E52). (Harbutt, 2010)

In First Order Logic:

$P4(x,y) \Rightarrow E2(x)$

$P4(x,y) \Rightarrow E52(y)$

P5 consists of (forms part of)

Domain:

E3 Condition State

Range:

E3 Condition State

Quantification:

many to many (0,n:0,n)

Scope note:

This property describes the decomposition of an instance of E3 Condition State into discrete, subsidiary states.

It is assumed that the sub-states into which the condition state is analysed form a logical whole - although the entire story may not be completely known – and that the sub-states are in fact constitutive of the general condition state. For example, a general condition state of “in ruins” may be decomposed into the individual stages of decay.

This property is transitive and non-reflexive.

Examples:

- The Condition State of the ruined Parthenon (E3) *consists of* the bombarded state after the explosion of a Venetian shell in 1687 (E3). (Mommsen, 1941)

In First Order Logic:

$P5(x,y) \Rightarrow E3(x)$

$P5(x,y) \Rightarrow E3(y)$

$[P5(x,y) \wedge P5(y,z)] \Rightarrow P5(x,z)$

$P5(x,y) \Rightarrow \neg P5(y,x)$

P7 took place at (witnessed)

Domain:

E4 Period

Range:

E53 Place

Superproperty of:

E92 Spacetime Volume. P161 has spatial projection (is spatial projection of): E53 Place

Quantification:

many to many, necessary (1,n:0,n)

Scope note:

This property describes the spatial location of an instance of E4 Period.

The related instance of E53 Place should be seen as a wider approximation of the geometric area within which the phenomena that characterise the period in question occurred, see below. *P7 took place at (witnessed)* does not convey any meaning other than spatial positioning (frequently on the surface of the earth). For example, the period “Révolution française” can be said to have taken place in “France in 1789”; the “Victorian” period may be said to have taken place in “Britain from 1837-1901” and its colonies, as well as other parts of Europe and North

America. An instance of E4 Period can take place at multiple non-contiguous, non-overlapping locations.

This property is a shortcut of the more fully developed path from E4 Period through *P161 has spatial projection*, E53 Place, *P89 falls within* to E53 Place. E4 Period is a subclass of E92 Spacetime Volume. By the definition of *P161 has spatial projection* an instance of E4 Period takes place on all its spatial projections, that is, instances of E53 Place. Something happening at a given place can also be considered to happen at a larger place containing the first. For example, the assault on the Bastille July 14th 1789 took place in the area covered by Paris in 1789 but also in the area covered by France in 1789.

Examples:

- The period “Révolution française” (E4) *took place at* the area covered by France in 1789 (E53). (Bertaud, 2004)

In First Order Logic:

$P7(x,y) \Rightarrow E4(x)$

$P7(x,y) \Rightarrow E53(y)$

P8 took place on or within (witnessed)

Domain:

E4 Period

Range:

E18 Physical Thing

Quantification:

many to many (0,n:0,n)

Scope note:

This property describes the location of an instance of E4 Period with respect to an instance of E19 Physical Object.

This property is a shortcut of the more fully developed path from E4 Period through *P7 took place at*, E53 Place, *P156i is occupied by* E18 Physical Thing.

It describes a period that can be located with respect to the space defined by an E19 Physical Object such as a ship or a building. The precise geographical location of the object during the period in question may be unknown or unimportant.

For example, the French and German armistice of 22 June 1940 was signed in the same railway carriage as the armistice of 11 November 1918.

Examples:

- The coronation of Queen Elizabeth II (E7) *took place on or within* Westminster Abbey (E18). (Strong, 2005)

In First Order Logic:

$P8(x,y) \Rightarrow E4(x)$

$P8(x,y) \Rightarrow E18(y)$

$P8(x,y) \Leftarrow (\exists z) [E53(z) \wedge P7(x,z) \wedge P156i(z,y)]$

P9 consists of (forms part of)

Domain:

E4 Period

Range:

E4 Period

Subproperty of:

E92 Spacetime Volume. P10i contains: E92 Spacetime Volume

Quantification:

many to many (0,n:0,n)

Scope note:

This property associates an instance of E4 Period with another instance of E4 Period that is defined by a subset of the phenomena that define the former. Therefore, the spacetime volume of the latter must fall within the spacetime volume of the former.

This property is transitive and non-symmetric.

Examples:

• Cretan Bronze Age (E4) *consists of* Middle Minoan (E4). (Hood, 1971)

In First Order Logic:

$P9(x,y) \Rightarrow E4(x)$

$P9(x,y) \Rightarrow E4(y)$

$P9(x,y) \Rightarrow P10(y,x)$

$[P9(x,y) \wedge P9(y,z)] \Rightarrow P9(x,z)$

$P9(x,y) \Rightarrow \neg P9(y,x)$

P10 falls within (contains)

Domain:

E92 Spacetime Volume

Range:

E92 Spacetime Volume

Subproperty of:

E92 Spacetime Volume. P132 spatiotemporally overlaps with: E92 Spacetime Volume

Superproperty of:

E93 Presence. P166 was a presence of (had presence): E92 Spacetime Volume

E4 Period. P9i forms part of: E4 Period

Quantification:

many to many, necessary, dependent (1,n:0,n)

Scope note:

This property associates an instance of E92 Spacetime Volume with another instance of E92 Spacetime Volume that falls within the latter. In other words, all points in the former are also points in the latter.

This property is transitive and reflexive.

Examples:

- The Great Plague (E4) *falls within* The Gothic period (E4). (Porter, 2009)

In First Order Logic:

$P10(x,y) \Rightarrow E92(x)$
 $P10(x,y) \Rightarrow E92(y)$
 $P10(x,y) \Rightarrow P132(x,y)$
 $P10(x,y) \wedge P10(y,z) \Rightarrow P10(x,z)$
 $P10(x,x)$

P11 had participant (participated in)

Domain:

E5 Event

Range:

E39 Actor

Subproperty of:

E5 Event. P12 occurred in the presence of (was present at): E77 Persistent Item

Superproperty of:

E7 Activity. P14 carried out by (performed): E39 Actor
E67 Birth. P96 by mother (gave birth): E21 Person
E68 Dissolution. P99 dissolved (was dissolved by): E74 Group
E85 Joining. P143 joined (was joined by): E39 Actor
E85 Joining. P144 joined with (gained member by): E74 Group
E86 Leaving. P145 separated (left by): E39 Actor
E86 Leaving. P146 separated from (lost member by): E74 Group
E66 Formation. P151 was formed from (participated in): E74 Group

Quantification:

many to many (0,n:0,n)

Scope note:

This property describes the active or passive participation of instances of E39 Actors in an instance of E5 Event.

It documents known events in which an instance of E39 Actor has participated during the course of that actor's life or history. The instances of E53 Place and E52 Time-Span where and when these events happened provide us with constraints about the presence of the related instances of E39 Actor in the past. Collective actors, i.e., instances of E74 Group, may physically participate in events via their representing instances of E21 Persons only. The participation of multiple actors in an event is most likely an indication of their acquaintance and interaction.

The property implies that the actor was involved in the event but does not imply any causal relationship. For instance, someone having been portrayed can be said to have participated in the creation of the portrait.

Examples:

- Napoleon (E21) *participated in* The Battle of Waterloo (E7). (Dawson, 2018)
- Maria (E21) *participated in* Photographing of Maria (E7). (fictitious)

In First Order Logic:

$P11(x,y) \Rightarrow E5(x)$

$P11(x,y) \Rightarrow E39(y)$
 $P11(x,y) \Rightarrow P12(x,y)$

P12 occurred in the presence of (was present at)

Domain:

E5 Event

Range:

E77 Persistent Item

Superproperty of:

E5 Event. P11 had participant (participated in): E39 Actor
E7 Activity. P16 used specific object (was used for): E70 Thing
E9 Move. P25 moved (moved by): E19 Physical Object
E11 Modification. P31 has modified (was modified by): E18 Physical Thing
E63 Beginning of Existence. P92 brought into existence (was brought into existence by): E77 Persistent Item
E64 End of Existence. P93 took out of existence (was taken out of existence by): E77 Persistent Item
E80 Part Removal. P113 removed (was removed by): E18 Physical Thing

Quantification:

many to many, necessary (1,n:0,n)

Scope note:

This property describes the active or passive presence of an E77 Persistent Item in an instance of E5 Event without implying any specific role.

It documents known events in which an instance of E77 Persistent Item was present during the course of its life or history. For example, an object may be the desk, now in a museum, on which a treaty was signed. The instance of E53 Place and the instance of E52 Time-Span where and when these events happened provide us with constraints about the presence of the related instance E77 Persistent Item in the past. Instances of E90 Symbolic Object, in particular information objects, are physically present in events via at least one of the instances of E18 Physical Thing carrying them. Note, that the human mind can be such a carrier. A precondition for a transfer of information to a person or another new physical carrier is the presence of the respective information object and this person or physical thing in one event.

Examples:

- Deckchair 42 (E19) was *present at* the sinking of the Titanic (E5). (Aldridge, 2008)

In First Order Logic:

$P12(x,y) \Rightarrow E5(x)$
 $P12(x,y) \Rightarrow E77(y)$

P13 destroyed (was destroyed by)

Domain:

E6 Destruction

Range:

E18 Physical Thing

Subproperty of:

E64 End of Existence. P93 took out of existence (was taken out of existence by): E77
Persistent Item

Quantification:

one to many, necessary (1,n:0,1)

Scope note:

This property links an instance of E6 Destruction to an instance of E18 Physical Thing that has been destroyed by it.

Destruction implies the end of an item's life as a subject of cultural documentation – the physical matter of which the item was composed may in fact continue to exist. An instance of E6 Destruction may be contiguous with an instance of E12 Production that brings into existence a derived object composed partly of matter from the destroyed object.

Examples:

- The Tay Bridge Disaster (E6) *destroyed* The Tay Bridge (E22). (Thomas, 1972)

In First Order Logic:

$P13(x,y) \Rightarrow E6(x)$
 $P13(x,y) \Rightarrow E18(y)$
 $P13(x,y) \Rightarrow P93(x,y)$

P14 carried out by (performed)

Domain:

E7 Activity

Range:

E39 Actor

Subproperty of:

E5 Event. P11 had participant (participated in): E39 Actor

Superproperty of:

E8 Acquisition. P22 transferred title to (acquired title through): E39 Actor
E8 Acquisition. P23 transferred title from (surrendered title through): E39 Actor
E10 Transfer of Custody. P28 custody surrendered by (surrendered custody through): E39 Actor
E10 Transfer of Custody. P29 custody received by (received custody through): E39 Actor

Quantification:

many to many, necessary (1,n:0,n)

Scope note:

This property describes the active participation of an instance of E39 Actor in an instance of E7 Activity.

It implies causal or legal responsibility. The *P14.1 in the role of* property of the property specifies the nature of an Actor's participation.

Examples:

- The painting of the Sistine Chapel (E7) *carried out by* Michelangelo Buonaroti (E21) *in the role of* master craftsman (E55). (Goldscheider, 1953)

In First Order Logic:

$P14(x,y) \Rightarrow E7(x)$
 $P14(x,y) \Rightarrow E39(y)$
 $P14(x,y) \Rightarrow P11(x,y)$
 $P14(x,y,z) \Rightarrow [P14(x,y) \wedge E55(z)]$

Properties:

P14.1 in the role of: E55 Type

P15 was influenced by (influenced)

Domain:

E7 Activity

Range:

E1 CRM Entity

Superproperty of:

E7 Activity. P16 used specific object (was used for): E70 Thing
E7 Activity. P17 was motivated by (motivated): E1 CRM Entity
E7 Activity. P134 continued (was continued by): E7 Activity
E83 Type Creation. P136 was based on (supported type creation): E1 CRM Entity

Quantification:

many to many (0,n:0,n)

Scope note:

This is a high-level property, which captures the relationship between an instance of E7 Activity and anything, that is, an instance of E1 CRM Entity that may have had some bearing upon it.

The property has more specific sub properties.

Examples:

- The designing of the Sydney Harbour Bridge (E7) *was influenced by* the Tyne bridge (E22). (Dorman Long, 1932)

In First Order Logic:

$P15(x,y) \Rightarrow E7(x)$
 $P15(x,y) \Rightarrow E1(y)$

P16 used specific object (was used for)

Domain:

E7 Activity

Range:

E70 Thing

Subproperty of:

E5 Event. P12 occurred in the presence of (was present at): E77 Persistent Item
E7 Activity. P15 was influenced by (influenced): E1 CRM Entity

Superproperty of:

E7 Activity. P33 used specific technique (was used by): E29 Design or Procedure
E15 Identifier Assignment. P142 used constituent (was used in): E90 Symbolic Object
E79 Part Addition. P111 added (was added by): E18 Physical Thing

Quantification:

many to many (0,n:0,n)

Scope note:

This property describes the use of material or immaterial things in a way essential to the performance or the outcome of an instance of E7 Activity.

This property typically applies to tools, instruments, moulds, raw materials and items embedded in a product. It implies that the presence of the object in question was a necessary condition for the action. For example, the activity of writing this text required the use of a computer. An immaterial thing can be used if at least one of its carriers is present. For example, the software tools on a computer.

Another example is the use of a particular name by a particular group of people over some span to identify a thing, such as a settlement. In this case, the physical carriers of this name are at least the people understanding its use.

Examples:

- The writing of the scope note of the CIDOC CRM property “P16 used specific object” contained in the CIDOC CRM version 4.1 (E7) *used specific object* Nicholas Crofts’ computer (E22) *mode of use* Typing Tool; Storage Medium (E55). [the original scope note was later extended in the CIDOC CRM version 4.3]
- The people of Iraq calling the place identified by TGN ‘7017998’ (E7) *used specific object* “Quyunjig” (E41) *mode of use* current; vernacular (E55).

In First Order Logic:

$P16(x,y) \Rightarrow E7(x)$

$P16(x,y) \Rightarrow E70(y)$

$P16(x,y) \Rightarrow P12(x,y)$

$P16(x,y) \Rightarrow P15(x,y)$

$P16(x,y,z) \Rightarrow [P16(x,y) \wedge E55(z)]$

Properties:

P16.1 mode of use: E55 Type

P17 was motivated by (motivated)

Domain:

E7 Activity

Range:

E1 CRM Entity

Subproperty of:

E7 Activity. P15 was influenced by (influenced): E1 CRM Entity

Quantification:

many to many (0,n:0,n)

Scope note:

This property describes an item or items that are regarded as a reason for carrying out the instance of E7 Activity.

For example, the discovery of a large hoard of treasure may call for a celebration, an order from headquarters can start a military manoeuvre.

Examples:

- The resignation of the chief executive (E7) *was motivated by* the collapse of SwissAir (E68).
- The coronation of Elizabeth II (E7) *was motivated by* the death of George VI (E69). (Strong, 2005)

In First Order Logic:

$P17(x,y) \Rightarrow E7(x)$
 $P17(x,y) \Rightarrow E1(y)$
 $P17(x,y) \Rightarrow P15(x,y)$

P19 was intended use of (was made for):

Domain:

E7 Activity

Range:

E71 Human-Made Thing

Quantification:

many to many (0,n:0,n)

Scope note:

This property relates an instance of E7 Activity with instances of E71 Human-Made Thing, created specifically for use in the activity.

This is distinct from the intended use of an item in some general type of activity such as the book of common prayer which was intended for use in Church of England services (see *P101 had as general use (was use of)*).

Examples:

- Lady Diana Spencer's wedding dress (E71) *was made for* Wedding of Prince Charles and Lady Diana Spencer (E7) *mode of use* To Be Worn (E55). (Daly, 1981)

In First Order Logic:

$P19(x,y) \Rightarrow E7(x)$
 $P19(x,y) \Rightarrow E71(y)$
 $P19(x,y,z) \Rightarrow [P19(x,y) \wedge E55(z)]$

Properties:

P19.1 mode of use: E55 Type

P20 had specific purpose (was purpose of)

Domain:

E7 Activity

Range:

E5 Event

Quantification:

many to many (0,n:0,n)

Scope note:

This property identifies the relationship between a preparatory activity, an instance of E7 Activity and the instance of E7-E5 Event it is intended to be preparation for.

This includes activities, orders and other organisational actions, taken in preparation for other activities or events.

P20 had specific purpose (was purpose of) implies that an activity succeeded in achieving its aim. If it does not succeed, such as the setting of a trap that did not catch anything, one may document the unrealized intention using *P21 had general purpose (was purpose of)*: E55 Type and/or *P33 used specific technique (was used by)*: E29 Design or Procedure.

Examples:

- Van Eyck's pigment grinding in 1432 (E7) *had specific purpose* the painting of the Ghent altar piece (E12). (Borchert, 2008)

In First Order Logic:

$P20(x,y) \Rightarrow E7(x)$

$P20(x,y) \Rightarrow E5(y)$

P21 had general purpose (was purpose of)

Domain:

E7 Activity

Range:

E55 Type

Quantification:

many to many (0,n:0,n)

Scope note:

This property describes an intentional relationship between an instance of E7 Activity and some general goal or purpose, described as an instance of E55 Type.

This may involve activities intended as preparation for some type of activity or event. *P21 had general purpose (was purpose of)* differs from *P20 had specific purpose (was purpose of)* in that no occurrence of an event is implied as the purpose.

Examples:

- Van Eyck's pigment grinding (E7) *had general purpose* painting (E55). (Borchert, 2008)
- The setting of trap 2742 on 17th of May 1874 (E7) *had general purpose* catching moose (E55). [Activity type] (fictitious)
- The construction of the Berlin Wall starting 13th of August 1961 (E12) *had general purpose* preventing emigration (E55). (History.com Editors, 2020)
- The reinforcement of the Mexico-United States barrier between the United States of America and Mexico in Fall 2019 (E11) *had general purpose* preventing immigration (E55).
- The rebuilding of the city walls of Heraklion by the Venetian rulers starting in 1462 (E12) *had general purpose* preventing conquest by enemy (E55). (YouIngGreece.com, 2020)
- The building of the seawall in Hamamatsu, Shizuoka, Japan between 2014 and 2020 (E12) *had general purpose* preventing inland flooding by tsunami (E55).

In First Order Logic:

$P21(x,y) \Rightarrow E7(x)$

$P21(x,y) \Rightarrow E55(y)$

P22 transferred title to (acquired title through)

Domain:

E8 Acquisition

Range:

E39 Actor

Subproperty of:

E7 Activity, P14 carried out by (performed): E39 Actor

Quantification:

many to many (0,n:0,n)

Scope note:

This property identifies the instance of E39 Actor that acquires the legal ownership of an object as a result of an instance of E8 Acquisition.

The property will typically describe an Actor purchasing or otherwise acquiring an object from another Actor. However, title may also be acquired, without any corresponding loss of title by another Actor, through legal fieldwork such as hunting, shooting or fishing.

In reality the title is either transferred to or from someone, or both.

Examples:

- The acquisition of the Amoudrouz collection by the Geneva Ethnography Museum (E8) *transferred title to* the Geneva Ethnography Museum (E74).

In First Order Logic:

$P22(x,y) \Rightarrow E8(x)$

$P22(x,y) \Rightarrow E39(y)$

$P22(x,y) \Rightarrow P14(x,y)$

P23 transferred title from (surrendered title through)

Domain:

E8 Acquisition

Range:

E39 Actor

Subproperty of:

E7 Activity, P14 carried out by (performed): E39 Actor

Quantification:

many to many (0,n:0,n)

Scope note:

This property identifies the instance(s) of E39 Actor who relinquish legal ownership as the result of an instance of E8 Acquisition.

The property will typically be used to describe a person donating or selling an object to a museum. In reality title is either transferred to or from someone, or both.

Examples:

- The acquisition of the Amoudrouz collection by the Geneva Ethnography Museum (E8) *transferred title from* the Heirs of Amoudrouz (E74).

In First Order Logic:

$P23(x,y) \Rightarrow E8(x)$
 $P23(x,y) \Rightarrow E39(y)$
 $P23(x,y) \Rightarrow P14(x,y)$

P24 transferred title of (changed ownership through)

Domain:

E8 Acquisition

Range:

E18 Physical Thing

Quantification:

many to many, necessary (1,n:0,n)

Scope note:

This property identifies the instance(s) of E18 Physical Thing involved in an instance of E8 Acquisition.

In reality, an acquisition must refer to at least one transferred item.

Examples:

- The acquisition of the Amoudrouz collection by the Geneva Ethnography Museum (E8) *transferred title of* the Amoudrouz Collection (E78).

In First Order Logic:

$P24(x,y) \Rightarrow E8(x)$
 $P24(x,y) \Rightarrow E18(y)$

P25 moved (moved by)

Domain:

E9 Move

Range:

E19 Physical Object

Subproperty of:

E5 Event. P12 occurred in the presence of (was present at): E77 Persistent Item

Quantification:

many to many, necessary (1,n:0,n)

Scope note:

This property identifies an instance of E19 Physical Object that was moved by an instance of E9 Move. A move must concern at least one object.

The property implies the object's passive participation. For example, Monet's painting "Impression sunrise" was moved for the first Impressionist exhibition in 1874.

Examples:

- Monet's "Impression sunrise" (E22) *moved by* preparations for the First Impressionist Exhibition (E9).

In First Order Logic:

$P25(x,y) \Rightarrow E9(x)$
 $P25(x,y) \Rightarrow E19(y)$
 $P25(x,y) \Rightarrow P12(x,y)$

P26 moved to (was destination of)

Domain:

E9 Move

Range:

E53 Place

Quantification:

many to many, necessary (1,n:0,n)

Scope note:

This property identifies a destination, an instance of E53 place, of an instance of E9 Move.

A move will be linked to a destination, such as the move of an artifact from storage to display. A move may be linked to many terminal instances of E53 Place by multiple instances of this property. In this case the move describes a distribution of a set of objects. The area of the move includes the origin(s), route and destination(s).

Therefore, the described destination is an instance of E53 Place which *P89 falls within (contains)* the instance of E53 Place the move *P7 took place at*.

Examples:

- The movement of the exhibition "Tutankhamun: Treasures of the Golden Pharaoh" between 15th of September and 2nd of November 2019 (E9) *moved to* the Saatchi Gallery London (E53).

In First Order Logic:

$P26(x,y) \Rightarrow E9(x)$
 $P26(x,y) \Rightarrow E53(y)$
 $P26(x,y) \Rightarrow (\exists z)[E53(z) \wedge P7(x,z) \wedge P89(y,z)]$

P27 moved from (was origin of)

Domain:

E9 Move

Range:

E53 Place

Quantification:

many to many, necessary (1,n:0,n)

Scope note:

This property identifies an origin, an instance of E53 Place, of an instance of E9 Move.

A move will be linked to an origin, such as the move of an artifact from storage to display. A move may be linked to many starting instances of E53 Place by multiple instances of this

property. In this case the move describes the picking up of a set of objects. The area of the move includes the origin(s), route and destination(s).

Therefore, the described origin is an instance of E53 Place which *P89 falls within (contains)* the instance of E53 Place the move *P7 took place at*.

Examples:

- The movement of the exhibition "Tutankhamun: Treasures of the Golden Pharaoh" between 15th of September and 2nd of November 2019 (E9) *moved from* Paris, Grande Halle de la Villette (E53).

In First Order Logic:

$P27(x,y) \Rightarrow E9(x)$
 $P27(x,y) \Rightarrow E53(y)$
 $P27(x,y) \Rightarrow (\exists z)[E53(z) \wedge P7(x,z) \wedge P89(y,z)]$

P28 custody surrendered by (surrendered custody through)

Domain:

E10 Transfer of Custody

Range:

E39 Actor

Subproperty of:

E7 Activity. P14 carried out by (performed): E39 Actor

Quantification:

many to many (0,n:0,n)

Scope note:

This property identifies the instance(s) of E39 Actor who surrender custody of an instance of E18 Physical Thing in an instance of E10 Transfer of Custody.

The property will typically describe an Actor surrendering custody of an object when it is handed over to someone else's care. On occasion, physical custody may be surrendered involuntarily – through accident, loss or theft.

In reality, custody is either transferred to someone or from someone, or both.

Examples:

- The Secure Deliveries Inc. crew (E74) *surrendered custody through* The delivery of the paintings by Secure Deliveries Inc. to the National Gallery (E10).

In First Order Logic:

$P28(x,y) \Rightarrow E10(x)$
 $P28(x,y) \Rightarrow E39(y)$
 $P28(x,y) \Rightarrow P14(x,y)$

P29 custody received by (received custody through)

Domain:

E10 Transfer of Custody

Range:

E39 Actor

Subproperty of:

E7 Activity. P14 carried out by (performed): E39 Actor

Quantification:

many to many (0,n:0,n)

Scope note:

This property identifies the instance(s) E39 Actor who receive custody of an instance of E18 Physical Thing in an instance of E10 Transfer of Custody.

The property will typically describe Actors receiving custody of an object when it is handed over from another Actor's care. On occasion, physical custody may be received involuntarily or illegally – through accident, unsolicited donation, or theft.

In reality, custody is either transferred to someone or from someone, or both.

Examples:

- Representatives of The National Gallery (E74) *received custody through* the delivery of the paintings by Secure Deliveries Inc. to the National Gallery (E10).

In First Order Logic:

$P29(x,y) \Rightarrow E10(x)$

$P29(x,y) \Rightarrow E39(y)$

$P29(x,y) \Rightarrow P14(x,y)$

P30 transferred custody of (custody transferred through)

Domain:

E10 Transfer of Custody

Range:

E18 Physical Thing

Quantification:

many to many, necessary (1,n:0,n)

Scope note:

This property identifies the instance(s) of E18 Physical Thing concerned in an instance of E10 Transfer of Custody.

The property will typically describe the object that is handed over by an instance of E39 Actor to to the custody of another instance of E39 Actor. On occasion, physical custody may be transferred involuntarily or illegally – through accident, unsolicited donation, or theft.

Examples:

- The delivery of the paintings by Secure Deliveries Inc. to the National Gallery (E10) *transferred custody of* paintings from The Iveagh Bequest (E19).

In First Order Logic:

$P30(x,y) \Rightarrow E10(x)$

$P30(x,y) \Rightarrow E18(y)$

P31 has modified (was modified by)

Domain:

[E11](#) Modification

Range:

[E18](#) Physical Thing

Subproperty of:

[E5](#) Event. [P12](#) occurred in the presence of (was present at): [E77](#) Persistent Item

Superproperty of:

[E12](#) Production. [P108](#) has produced (was produced by): [E24](#) Physical Human-Made Thing

[E79](#) Part Addition. [P110](#) augmented (was augmented by): ~~[E24](#)~~ [E18](#) Physical ~~Human-Made~~ Thing

[E80](#) Part Removal. [P112](#) diminished (was diminished by): [E18](#) Physical Thing~~[E24](#) Physical Human-Made Thing~~

Quantification:

many to many, necessary (1,n:0,n)

Scope note:

This property identifies the instance of [E18](#) Physical Thing modified in an instance of [E11](#) Modification.

Examples:

- The rebuilding of the German Reichstag in Berlin ([E11](#)) *has modified* the Reichstag in Berlin ([E24](#)). (Foster, 2000)

In First Order Logic:

$P31(x,y) \Rightarrow E11(x)$

$P31(x,y) \Rightarrow E18(y)$

$P31(x,y) \Rightarrow P12(x,y)$

P32 used general technique (was technique of)

Domain:

[E7](#) Activity

Range:

[E55](#) Type

Subproperty of:

[E7](#) Activity. [P125](#) used object of type (was type of object used in): [E55](#) Type

Quantification:

many to many (0,n:0,n)

Scope note:

This property identifies the technique or method, modelled as an instance of [E55](#) Type, that was employed in an instance of [E7](#) Activity.

These techniques should be drawn from an external [E55](#) Type hierarchy of consistent terminology of general techniques or methods such as embroidery, oil-painting, carbon dating, etc. Specific documented techniques should be described as instances of [E29](#) Design or Procedure.

Examples:

- The ornamentation of silver cup 113 (E11) *used general technique* gold-plating (E55). [A Design or Procedure type] (fictitious)

In First Order Logic:

$P32(x,y) \Rightarrow E7(x)$
 $P32(x,y) \Rightarrow E55(y)$
 $P32(x,y) \Rightarrow P125(x,y)$

P33 used specific technique (was used by)

Domain:

E7 Activity

Range:

E29 Design or Procedure

Subproperty of:

E7 Activity, P16 used specific object (was used for): E70 Thing

Quantification:

many to many (0,n:0,n)

Scope note:

This property identifies a specific instance of E29 Design or Procedure in order to carry out an instance of E7 Activity or parts of it.

The property differs from *P32 used general technique (was technique of)* in that P33 refers to an instance of E29 Design or Procedure, which is a concrete information object in its own right rather than simply being a term or a method known by tradition.

Typical examples would include intervention plans for conservation or the construction plans of a building.

Examples:

- The ornamentation of silver cup 232 (E11) *used specific technique* 'Instructions for golden chase work by A N Other' (E29). (fictitious)
- The rebuilding of the German Reichstag in Berlin (E11) *used specific technique* Architectural plans by Foster and Partners (E29). (Foster, 2000)

In First Order Logic:

$P33(x,y) \Rightarrow E7(x)$
 $P33(x,y) \Rightarrow E29(y)$
 $P33(x,y) \Rightarrow P16(x,y)$

P34 concerned (was assessed by)

Domain:

E14 Condition Assessment

Range:

E18 Physical Thing

Subproperty of:

E13 Attribute Assignment, P140 assigned attribute to (was attributed by): E1 CRM Entity

Quantification:

many to many, necessary (1,n:0,n)

Scope note:

This property identifies the instance of E18 Physical Thing that was assessed during an instance of E14 Condition Assessment activity.

Conditions may be assessed either by direct observation or using recorded evidence. In the latter case the instance of E18 Physical Thing does not need to be present or extant at the time of assessment.

Examples:

- The condition assessment of the silver collection in 1997 (E14) *concerned* silver cup 232 (E22). (fictitious)
- The condition assessment of the cover of MS Sinai Greek 418 (E14) *concerned* the cover of MS Sinai Greek 418 (E22). (Honey and Pickwood, 2010)
- The condition assessment of the endband cores of MS Sinai Greek 418 (E14) *concerned* the endband cores of MS Sinai Greek 418 (E22). (Honey and Pickwood, 2010)

In First Order Logic:

$P34(x,y) \Rightarrow E14(x)$

$P34(x,y) \Rightarrow E18(y)$

$P34(x,y) \Rightarrow P140(x,y)$

P35 has identified (was identified by)

Domain:

E14 Condition Assessment

Range:

E3 Condition State

Subproperty of:

E13 Attribute Assignment. P141 assigned (was assigned by): E1 CRM Entity

Quantification:

many to many, necessary (1,n:0,n)

Scope note:

This property identifies the instance of E3 Condition State that was observed in an instance of E14 Condition Assessment activity.

Examples:

- The condition assessment of silver cup 232 in 1997 (E14) *has identified* oxidation traces were present in 1997 (E3). [which *has type* (P2) with oxidation traces (E55)] (fictitious)
- The condition assessment of the cover of MS Sinai Greek 418 (E13) *has identified* the condition state in November 2003 (E3). [which *has type* fine (E55)] (Honey and Pickwood, 2010)
- The condition assessment of the endband cores of MS Sinai Greek 418 (E14) *has identified* the condition state in November 2003 (E3). [which *has type* broken (E55)] (Honey and Pickwood, 2010)

In First Order Logic:

$P35(x,y) \Rightarrow E14(x)$

$P35(x,y) \Rightarrow E3(y)$

$P35(x,y) \Rightarrow P141(x,y)$

P37 assigned (was assigned by)

Domain:

E15 Identifier Assignment

Range:

E42 Identifier

Subproperty of:

E13 Attribute Assignment. P141 assigned (was assigned by): E1 CRM Entity

Quantification:

many to many (0,n:0,n)

Scope note:

This property records the identifier that was assigned to an item in an instance of P37 Identifier Assignment.

The same identifier may be assigned on more than one occasion.

An Identifier might be created prior to an assignment.

Examples:

- The identifier assignment on 1st of June 1997 of the silver cup donated by Martin Doerr (E15) *assigned* "232" (E42) (fictitious)

In First Order Logic:

$P37(x,y) \Rightarrow E15(x)$

$P37(x,y) \Rightarrow E42(y)$

$P37(x,y) \Rightarrow P141(x,y)$

P38 deassigned (was deassigned by)

Domain:

E15 Identifier Assignment

Range:

E42 Identifier

Subproperty of:

E13 Attribute Assignment. P141 assigned (was assigned by): E1 CRM Entity

Quantification:

many to many (0,n:0,n)

Scope note:

This property records the identifier that was deassigned from an instance of E1 CRM Entity.

De-assignment of an identifier may be necessary when an item is taken out of an inventory, a new numbering system is introduced or items are merged or split up.

The same identifier may be deassigned on more than one occasion.

Examples:

- The identifier assignment on 31st July 2001 of the silver cup OXCMS:2001.1.32 (E15) *deassigned* “232” (E42). (fictitious)

In First Order Logic:

$P38(x,y) \Rightarrow E15(x)$
 $P38(x,y) \Rightarrow E42(y)$
 $P38(x,y) \Rightarrow P141(x,y)$

P39 measured (was measured by)

Domain:

E16 Measurement

Range:

E18 Physical Thing

Subproperty of:

E13 Attribute Assignment. P140 assigned attribute to (was attributed by): E1 CRM Entity

Quantification:

many to one, necessary (1,1:0,n)

Scope note:

This property associates an instance of E16 Measurement with the instance of E18 Physical Thing upon which it acted. The instance of E16 Measurement is specific to the measured object. An instance of E18 Physical Thing may be measured more than once with different results, constituting different instances of E16 Measurement.

Examples:

- The measurement of the height of silver cup 232 on 31st of August 1997 (E16) *measured* silver cup 232 (E22). (fictitious)
- The carbon 14 dating of the “Schoeningen Speer II” in 1996 (E16) *measured* the “Schoeningen Speer II” (E22). [The carbon 14 dating of an approximately 400.000 year old complete Old Palaeolithic wooden spear found in Schoeningen, Niedersachsen, Germany, in 1995. See also, E16 Measurement.] (Kouwenhoven, 1997)

In First Order Logic:

$P39(x,y) \Rightarrow E16(x)$
 $P39(x,y) \Rightarrow E18(y)$
 $P39(x,y) \Rightarrow P140(x,y)$

P40 observed dimension (was observed in)

Domain:

E16 Measurement

Range:

E54 Dimension

Subproperty of:

E13 Attribute Assignment. P141 assigned (was assigned by): E1 CRM Entity

Quantification:

many to many, necessary (1,n:0,n)

Scope note:

This property records the dimension that was observed in an E16 Measurement Event.

E54 Dimension can be any quantifiable aspect of E70 Thing. Weight, image colour depth and monetary value are dimensions in this sense. One measurement activity may determine more than one dimension of one object.

Dimensions may be determined either by direct observation or using recorded evidence. In the latter case the measured Thing does not need to be present or extant.

Even though knowledge of the value of a dimension requires measurement, the dimension may be an object of discourse prior to, or even without, any measurement being made.

Examples:

- The measurement of the height of silver cup 232 on 31st of August 1997 (E16) *observed dimension* silver cup 232 height (E54). [which *has unit* mm (E58), *has value* 224 (E60)] (fictitious)
- The carbon 14 dating of the “Schoeninger Speer II” in 1996 (E16) *observed dimension* the carbon 14 based temporal distance from 1996 to the growth of the wood of the “Schoeninger Speer II” (E60). [The carbon 14 dating of an approximately 400.000 year old complete Old Palaeolithic wooden spear found in Schoeningen, Niederachsen, Germany, in 1995. See also: E16 Measurement.] (Kouwenhoven, 1997)

In First Order Logic:

$P40(x,y) \Rightarrow E16(x)$

$P40(x,y) \Rightarrow E54(y)$

$P40(x,y) \Rightarrow P141(x,y)$

P41 classified (was classified by)

Domain:

E17 Type Assignment

Range:

E1 CRM Entity

Subproperty of:

E13 Attribute Assignment. P140 assigned attribute to (was attributed by): E1 CRM Entity

Quantification:

many to one, necessary (1,1:0,n)

Scope note:

This property records the item to which a type was assigned in an E17 Type Assignment activity.

Any instance of a CIDOC CRM entity may be assigned a type through type assignment. Type assignment events allow a more detailed path from E1 CRM Entity through *P41i was classified by*, E17 Type Assignment, *P42 assigned*, to E55 Type for assigning types to objects compared to the shortcut offered by *P2 has type (is type of)*.

Examples:

- The classification of silver cup 232 on 31st of August 1997 (E17) *classified* silver cup 232 (E22). (fictitious)

In First Order Logic:

$P41(x,y) \Rightarrow E17(x)$

$P41(x,y) \Rightarrow E1(y)$
 $P41(x,y) \Rightarrow P140(x,y)$

P42 assigned (was assigned by)

Domain:

E17 Type Assignment

Range:

E55 Type

Subproperty of:

E13 Attribute Assignment. P141 assigned (was assigned by): E1 CRM Entity

Quantification:

many to many, necessary (1,n:0,n)

Scope note:

This property records the type that was assigned to an entity by an E17 Type Assignment activity.

Type assignment events allow a more detailed path from E1 CRM Entity through *P41i was classified by*, E17 Type Assignment, *P42 assigned*, to E55 Type for assigning types to objects compared to the shortcut offered by *P2 has type (is type of)*.

For example, a fragment of an antique vessel could be assigned the type “attic red figured belly handled amphora” by expert A. The same fragment could be assigned the type “shoulder handled amphora” by expert B.

A Type may be intellectually constructed independent from assigning an instance of it.

Examples:

- The classification of silver cup 232 on 31st August 1997 (E17) *assigned* goblet (E55). (fictitious)

In First Order Logic:

$P42(x,y) \Rightarrow E17(x)$
 $P42(x,y) \Rightarrow E55(y)$
 $P42(x,y) \Rightarrow P141(x,y)$

P43 has dimension (is dimension of)

Domain:

E70 Thing

Range:

E54 Dimension

Quantification:

one to many, dependent (0,n:1,1)

Scope note:

This property records a E54 Dimension of some E70 Thing.

In the case that the recorded property is a result of a measurement of an instance of E18 Physical Thing, this property is a shortcut of the more fully developed path from E18 Physical Thing through *P39i was measured by*, E16 Measurement, *P40 observed dimension* to E54 Dimension.

It offers no information about how and when an E54 Dimension was established, nor by whom. Knowledge about an instance of E54 Dimension need not be the result of a measurement; it may be the result of evaluating data or other information, which should be documented as an instance of E13 Attribute Assignment.

An instance of E54 Dimension is specific to an instance of E70 Thing.

Examples:

- Silver cup 232 (E22) *has dimension* height of silver cup 232 (E54). [which *has unit* (P91) mm (E58), *has value* (P90) 224 (E60)] (fictitious)

In First Order Logic:

$P43(x,y) \Rightarrow E70(x)$
 $P43(x,y) \Rightarrow E54(y)$
 $P43(x,y) \Leftarrow (\exists z) [E16(z) \wedge P39i(x,z) \wedge P40(z,y)]$

P44 has condition (is condition of)

Domain:

E18 Physical Thing

Range:

E3 Condition State

Quantification:

one to many, dependent (0,n:1,1)

Scope note:

This property records an E3 Condition State for some E18 Physical Thing.

This property is a shortcut of the more fully developed path from E18 Physical Thing through *P34i was assessed by*, E14 Condition Assessment, *P35 has identified* to E3 Condition State. It offers no information about how and when the E3 Condition State was established, nor by whom.

An instance of Condition State is specific to an instance of E18 Physical Thing.

Examples:

- Silver cup 232 (E22) *has condition* oxidation traces were present in 1997 (E3). [which *has type* (P2) oxidation traces (E55)] (fictitious)

In First Order Logic:

$P44(x,y) \Rightarrow E18(x)$
 $P44(x,y) \Rightarrow E3(y)$
 $P44(x,y) \Leftarrow (\exists z) [E14(z) \wedge P34i(x,z) \wedge P35(z,y)]$

P45 consists of (is incorporated in)

Domain:

E18 Physical Thing

Range:

E57 Material

Quantification:

many to many, necessary (1,n:0,n)

Scope note:

This property identifies the instances of E57 Materials of which an instance of E18 Physical Thing is composed.

All physical things consist of physical materials. *P45 consists of (is incorporated in)* allows the different materials to be recorded. *P45 consists of (is incorporated in)* refers here to observed material as opposed to the consumed raw material.

A material, such as a theoretical alloy, may not have any physical instances.

Examples:

- Silver cup 232 (E22) *consists of* silver (E57). (fictitious)

In First Order Logic:

$P45(x,y) \Rightarrow E18(x)$

$P45(x,y) \Rightarrow E57(y)$

P46 is composed of (forms part of)

Domain:

E18 Physical Thing

Range:

E18 Physical Thing

Superproperty of:

E19 Physical Object. P56 bears feature (is found on): E26 Physical Feature

Quantification:

many to many (0,n:0,n)

Scope note:

This property associates an instance of E18 Physical Thing with another instance of Physical Thing that forms part of it. The spatial extent of the composing part is included in the spatial extent of the whole.

Component elements, since they are themselves instances of E18 Physical Thing, may be further analysed into sub-components, thereby creating a hierarchy of part decomposition. An instance of E18 Physical Thing may be shared between multiple wholes, for example two buildings may share a common wall. This property does not specify when and for how long a component element resided in the respective whole. If a component is not part of a whole from the beginning of existence or until the end of existence of the whole, the classes E79 Part Addition and E90 Part Removal can be used to document when a component became part of a particular whole and/or when it stopped being a part of it. For the time-span of being part of the respective whole, the component is completely contained in the place the whole occupies.

This property is intended to describe specific components that are individually documented, rather than general aspects. Overall descriptions of the structure of an instance of E18 Physical Thing are captured by the *P3 has note* property.

The instances of E57 Material of which an instance of E18 Physical Thing is composed should be documented using *P45 consists of (is incorporated in)*.

This property is transitive and non-reflexive

Examples:

- The Royal carriage (E22) *forms part of* the Royal train (E22).

- The “Hog’s Back” (E24) *forms part of* the “Fosseway” (E24).

In First Order Logic:

$P46(x,y) \Rightarrow E18(x)$
 $P46(x,y) \Rightarrow E18(y)$
 $P46(x,y) \Rightarrow P132(x,y)$
 $[P46(x,y) \wedge P46(y,z)] \Rightarrow P46(x,z)$
 $P46(x,y) \Rightarrow (\exists uzw)[E93(u) \wedge P195i(x,u) \wedge E52(z) \wedge P164(u,z) \wedge E93(w) \wedge P195i(w,y) \wedge P164(w,z) \wedge P10(w,u)]$
 $\neg P46(x,x)$

P48 has preferred identifier (is preferred identifier of)

Domain:

E1 CRM Entity

Range:

E42 Identifier

Subproperty of:

E1 CRM Entity. P1 is identified by (identifies): E41 Appellation

Quantification:

many to one (0,1:0,n)

Scope note:

This property records the preferred instance of E42 Identifier that was used to identify an instance of E1 CRM Entity at the time this property was recorded.

More than one preferred identifier may have been assigned to an item over time.

Use of this property requires an external mechanism for assigning temporal validity to the respective CIDOC CRM instance.

The fact that an identifier is a preferred one for an organisation can be better expressed in a context independent form by assigning a suitable instance of E55 Type to the respective instance of E15 Identifier Assignment using the *P2 has type* property.

Examples:

- The pair of Lederhosen donated by Dr Martin Doerr (E22) *has preferred identifier* "OXCMS:2001.1.32" (E42). (fictitious)

In First Order Logic:

$P48(x,y) \Rightarrow E1(x)$
 $P48(x,y) \Rightarrow E42(y)$
 $P48(x,y) \Rightarrow P1(x,y)$

P49 has former or current keeper (is former or current keeper of)

Domain:

E18 Physical Thing

Range:

E39 Actor

Superproperty of:

E18 Physical Thing. P50 has current keeper (is current keeper of): E39 Actor

E78 Curated Holding. P109 has current or former curator (is current or former curator of): E39 Actor

Quantification:

many to many (0,n:0,n)

Scope note:

This property identifies the instance of E39 Actor who has or has had custody of an instance of E18 Physical Thing at some time. This property leaves open the question if parts of this physical thing have been added or removed during the time-spans it has been under the custody of this actor, but it is required that at least a part which can unambiguously be identified as representing the whole has been under this custody for its whole time. The way, in which a representative part is defined, should ensure that it is unambiguous who keeps a part and who the whole and should be consistent with the identity criteria of the kept instance of E18 Physical Thing.

The distinction with *P50 has current keeper (is current keeper of)* is that *P49 has former or current keeper (is former or current keeper of)* leaves open the question as to whether the specified keepers are current.

This property is a shortcut for the more detailed path from E18 Physical Thing through *P30i custody transferred through*, E10 Transfer of Custody, *P28 custody surrendered by or P29 custody received by* to E39 Actor.

Examples:

- The paintings from The Iveagh Bequest (E78) *has former or current keeper* Secure Deliveries Inc. (E74).

In First Order Logic:

$P49(x,y) \Rightarrow E18(x)$

$P49(x,y) \Rightarrow E39(y)$

$P49(x,y) \Leftarrow (\exists z) [E10(z) \wedge P30i(x,z) \wedge [P28(z,y) \vee P29(z,y)]]$

P50 has current keeper (is current keeper of)

Domain:

E18 Physical Thing

Range:

E39 Actor

Subproperty of:

E18 Physical Thing. P49 has former or current keeper (is former or current keeper of): E39 Actor

Quantification:

many to many (0,n:0,n)

Scope note:

This property identifies the instance of E39 Actor that had custody of an instance of E18 Physical Thing at the time of validity of the record or database containing the statement that uses this property.

This property is a shortcut for the more detailed path from E18 Physical Thing through, *P30i custody transferred through*, E10 Transfer of Custody, *P29 custody received by* to E39 Actor, if and only if the custody has not been surrendered by the receiving actor at any later time

Examples:

- The paintings from The Iveagh Bequest (E78) *has current keeper* The National Gallery (E74) (Iveagh Bequest, 1975)

In First Order Logic:

$P50(x,y) \Rightarrow E18(x)$
 $P50(x,y) \Rightarrow E39(y)$
 $P50(x,y) \Rightarrow P49(x,y)$
 $P50(x,y) \Leftarrow (\exists z) [[E10(z) \wedge P30i(x,z) \wedge P29(z,y)]$
 $\wedge \neg (\exists w) [E10(w) \wedge P30i(x,w) \wedge P28(w,y) \wedge P182(z,w)]]$

P51 has former or current owner (is former or current owner of)

Domain:

E18 Physical Thing

Range:

E39 Actor

Superproperty of:

E18 Physical Thing. P52 has current owner (is current owner of): E39 Actor

Quantification:

many to many (0,n:0,n)

Scope note:

This property identifies an instance of E39 Actor that is or had been the legal owner (i.e., title holder) of an instance of E18 Physical Thing at some time.

The distinction with *P52 has current owner (is current owner of)* is that *P51 has former or current owner (is former or current owner of)* does not indicate whether the specified owners are current.

This property is a shortcut for the more detailed path from E18 Physical Thing through *P24i changed ownership through*, E8 Acquisition, *P23 transferred title from*, or *P22 transferred title to* to E39 Actor.

Examples:

- The paintings from the Iveagh Bequest (E78) *has former or current owner* Lord Iveagh (E21). (Bryant, 1990)

In First Order Logic:

$P51(x,y) \Rightarrow E18(x)$
 $P51(x,y) \Rightarrow E39(y)$
 $P51(x,y) \Leftarrow (\exists z) [E8(z) \wedge P24i(x,z) \wedge [P23(z,y) \vee P22(z,y)]]$

P52 has current owner (is current owner of)

Domain:

E18 Physical Thing

Range:

E39 Actor

Subproperty of:

E18 Physical Thing. P51 has former or current owner (is former or current owner of): E39 Actor

E72 Legal Object. P105 right held by (has right on): E39 Actor

Quantification:

many to many (0,n:0,n)

Scope note:

This property identifies the instance of E21 Person or E74 Group that was the owner of an instance of E18 Physical Thing at the time of validity of the record or database containing the statement that uses this property.

This property is a shortcut for the more detailed path from E18 Physical Thing through, *P24i changed ownership through*, E8 Acquisition, *P22 transferred title to* to E39 Actor, if and only if this acquisition event is the most recent.

Examples:

- The paintings from the Iveagh Bequest (E78) *has current owner* Historic England (E74). [This is still valid 2021 CE. The important collection of Old Master and British portraits was bequeathed to Kenwood by Edward Cecil Guinness, 1st Earl of Iveagh, in 1927.] (Iveagh Bequest, 1975; Bryant, 1990)

In First Order Logic:

$P52(x,y) \Rightarrow E18(x)$

$P52(x,y) \Rightarrow E39(y)$

$P52(x,y) \Rightarrow P51(x,y)$

$P52(x,y) \Rightarrow P105(x,y)$

$P52(x,y) \Leftarrow (\exists z) [[E8(z) \wedge P24i(x,z) \wedge P22(z,y)]$
 $\wedge \neg (\exists w) [E8(w) \wedge P24i(x,w) \wedge P23(w,y) \wedge P182(z,w)]]$

P53 has former or current location (is former or current location of)

Domain:

E18 Physical Thing

Range:

E53 Place

Superproperty of:

E19 Physical Object. P55 has current location (currently holds): E53 Place

E18 Physical Thing. P156 occupies (is occupied by): E53 Place

Quantification:

many to many, necessary (1,n:0,n)

Scope note:

This property identifies an instance of E53 Place as the former or current location of an instance of E18 Physical Thing.

In the case of instances of E19 Physical Object, the property does not allow any indication of the Time-Span during which the instance of E19 Physical Object was located at this instance of E53 Place, nor if this is the current location.

In the case of immobile objects, the Place would normally correspond to the Place of creation.

This property is a shortcut. A more detailed representation can make use of the fully developed (i.e., indirect) path from E19 Physical Object, though, *P25i moved by*, E9 Move, *P26 moved to* or *P27 moved from* to E53 Place.

Examples:

- Silver cup 232 (E22) *has former or current location* Display Case 4, Room 23, Museum of Oxford (E53) (fictitious)

In First Order Logic:

$P53(x,y) \Rightarrow E18(x)$
 $P53(x,y) \Rightarrow E53(y)$
 $P53(x,y) \Leftarrow (\exists z) [E9(z) \wedge P25i(x,z) \wedge [P26(z,y) \vee P27(z,y)]]$

P54 has current permanent location (is current permanent location of)

Domain:

E19 Physical Object

Range:

E53 Place

Quantification:

many to one (0,1:0,n)

Scope note:

This property records the foreseen permanent location of an instance of E19 Physical Object at the time of validity of the record or database containing the statement that uses this property.

P54 has current permanent location (is current permanent location of) is similar to *P55 has current location (currently holds)*. However, it indicates the E53 Place currently reserved for an object, such as the permanent storage location or a permanent exhibit location. The object may be temporarily removed from the permanent location, for example when used in temporary exhibitions or loaned to another institution. The object may never actually be located at its permanent location.

Examples:

- Silver cup 232 (E22) *has current permanent location* Shelf 3.1, Store 2, Museum of Oxford (E53). (fictitious)

In First Order Logic:

$P54(x,y) \Rightarrow E19(x)$
 $P54(x,y) \Rightarrow E53(y)$

P55 has current location (currently holds)

Domain:

E19 Physical Object

Range:

E53 Place

Subproperty of:

E18 Physical Thing. P53 has former or current location (is former or current location of): E53 Place

Quantification:

many to many (0,n:0,n)

Scope note:

This property records the location of an instance of E19 Physical Object at the time of validity of the record or database containing the statement that uses this property.

This property is a specialisation of *P53 has former or current location (is former or current location of)*. It indicates that the instance of E53 Place associated with the instance of E19 Physical Object is the current location of the object. The property does not allow any indication of how long the object has been at the current location.

This property is a shortcut. A more detailed representation can make use of the fully developed (i.e., indirect) path from E19 Physical Object, through, *P25i moved by*, E9 Move, *P26 moved to* to E53 Place if and only if this Move is the most recent.

Examples:

- Silver cup 232 (E22) *has current location* Display Cabinet 23, Room 4, British Museum (E53). (fictitious)

In First Order Logic:

$P55(x,y) \Rightarrow E19(x)$
 $P55(x,y) \Rightarrow E53(y)$
 $P55(x,y) \Rightarrow P53(x,y)$
 $P55(x,y) \Leftarrow (\exists z) [[E9(z) \wedge P25i(x,z) \wedge P26(z,y)]$
 $\wedge \neg (\exists w) [E9(w) \wedge P25i(x,w) \wedge P27(w,y) \wedge P182(z,w)]]$

P56 bears feature (is found on)

Domain:

E19 Physical Object

Range:

E26 Physical Feature

Subproperty of:

E18 Physical Thing. P46 is composed of (forms part of): E18 Physical Thing

Quantification:

one to many, dependent (0,n:1,1)

Scope note:

This property links an instance of E19 Physical Object to an instance of E26 Physical Feature that it bears.

An instance of E26 Physical Feature can only exist on one object. One object may bear more than one E26 Physical Feature. An instance of E27 Site should be considered as an instance of E26 Physical Feature on the surface of the Earth.

An instance B of E26 Physical Feature being a detail of the structure of another instance A of E26 Physical Feature can be linked to B by use of the property *P46 is composed of (forms part of)*. This implies that the subfeature B is *P56i is found on* the same E19 Physical Object as A.

This property is a shortcut. A more detailed representation can make use of the fully developed (i.e., indirect) path *E19 Physical Object*, through, *P59 has section*, E53 Place, *P53i is former or current location of* to E26 Physical Feature.

Examples:

- Silver cup 232 (E22) *bears feature* 32 mm scratch on silver cup 232 (E26) (fictitious)

In First Order Logic:

$P56(x,y) \Rightarrow E19(x)$
 $P56(x,y) \Rightarrow E26(y)$
 $P56(x,y) \Rightarrow P46(x,y)$
 $P56(x,y) \Leftarrow (\exists z) [E53(z) \wedge P59(x,z) \wedge P53i(z,y)]$

P57 has number of parts

Domain:

E19 Physical Object

Range:

E60 Number

Quantification:

many to one (0,1:0,n)

Scope note:

This property documents the number of parts, an instance of E60 Number, of which an instance of E19 Physical Object is composed.

This may be used as a method of checking inventory counts with regard to aggregate or collective objects. What constitutes a part or component depends on the context and requirements of the documentation. Normally, the parts documented in this way would not be considered as worthy of individual attention.

For a more complete description, objects may be decomposed into their components and constituents using *P46 is composed of (forms parts of)* and *P45 consists of (is incorporated in)*. This allows each element to be described individually.

Examples:

• Chess set 233 (E22) *has number of parts* 33 (E60). (fictitious)

In First Order Logic:

$P57(x,y) \Rightarrow E19(x)$
 $P57(x,y) \Rightarrow E60(y)$

P59 has section (is located on or within)

Domain:

E18 Physical Thing

Range:

E53 Place

Quantification:

many to many (0,n:0,n)

Subproperty of:

E18 Physical Thing. P157i provides reference space for: E53 Place

Scope note:

This property links an area, i.e., an instance of E53 Place to the instance of E18 Physical Thing upon which it is found. This area may either be identified by a name, or by a geometry in terms of a coordinate system adapted to the shape of the respective instance of E18 Physical Thing.

Typically, names identifying sections of physical objects are composed of the name of a kind of part and the name of the object itself, such as "The poop deck of H.M.S. Victory", which is composed of "poop deck" and "H.M.S. Victory".

Examples:

- HMS Victory (E22) *has section* HMS Victory section B347.6 (E53). (Goodwin, 2015)

In First Order Logic:

$P59(x,y) \Rightarrow E18(x)$

$P59(x,y) \Rightarrow E53(y)$

P62 depicts (is depicted by)

Domain:

E24 Physical Human-Made Thing

Range:

E1 CRM Entity

Quantification:

many to many (0,n:0,n)

Scope note:

This property identifies something that is depicted by an instance of E24 Physical Human-Made Thing. Depicting is meant in the sense that an instance of E24 Physical Human-Made Thing intentionally shows, through its optical qualities or form, a representation of the entity depicted. Photographs are by default regarded as being intentional in this sense. Anything that is designed to change the properties of the depiction, such as an e-book reader, is specifically excluded. The property does not pertain to inscriptions or any other information encoding.

This property is a shortcut of the more fully developed path from E24 Physical Human-Made Thing through *P65 shows visual item*, E36 Visual Item, *P138 represents* to E1 CRM Entity. *P138.1 mode of depiction* allows the nature of the depiction to be refined.

Examples:

- The painting "La Liberté guidant le peuple" by Eugène Delacroix (E22) *depicts* the French "July Revolution" of 1830 (E7). (Delacroix, 1982)
- The 20 pence coin held by the Department of Coins and Medals of the British Museum under registration number 2006,1101.126 (E22) *depicts* Queen Elizabeth II (E21) *mode of depiction* Profile (E55).

In First Order Logic:

$P62(x,y) \Rightarrow E24(x)$

$P62(x,y) \Rightarrow E1(y)$

$P62(x,y,z) \Rightarrow [P62(x,y) \wedge E55(z)]$

$P62(x,y) \Leftarrow (\exists z) [E36(z) \wedge P65(x,z) \wedge P138(z,y)]$

Properties:

P62.1 mode of depiction: E55 Type

P65 shows visual item (is shown by)

Domain:

[E24](#) Physical Human-Made Thing

Range:

[E36](#) Visual Item

Subproperty of:

[E18](#) Physical Thing. [P128](#) carries (is carried by): [E90](#) Symbolic Object

Quantification:

many to many (0,n:0,n)

Scope note:

This property documents an instance of [E36](#) Visual Item shown by an instance of [E24](#) Physical Human-Made Thing.

This property is similar to *P62 depicts (is depicted by)* in that it associates an instance of [E24](#) Physical Human-Made Thing with a visual representation. However, *P65 shows visual item (is shown by)* differs from the *P62 depicts (is depicted by)* property in that it makes no claims about what the instance of [E36](#) Visual Item is deemed to represent. An instance of [E36](#) Visual Item identifies a recognisable image or visual symbol, regardless of what this image may or may not represent.

For example, all recent British coins bear a portrait of Queen Elizabeth II, a fact that is correctly documented using *P62 depicts (is depicted by)*. Different portraits have been used at different periods, however. *P65 shows visual item (is shown by)* can be used to refer to a particular portrait.

P65 shows visual item (is shown by) may also be used for Visual Items such as signs, marks and symbols, for example the 'Maltese Cross' or the 'copyright symbol' that have no particular representational content.

This property is part of the fully developed path [E24](#) Physical Human-Made Thing, *P65 shows visual item*, [E36](#) Visual Item, *P138 represents to* [E1](#) CRM Entity which is shortcut by, *P62 depicts (is depicted by)*.

Examples:

- My T-Shirt ([E22](#)) *shows visual item* Mona Lisa ([E36](#)). (fictitious)

In First Order Logic:

$P65(x,y) \Rightarrow E24(x)$

$P65(x,y) \Rightarrow E36(y)$

$P65(x,y) \Rightarrow P128(x,y)$

P67 refers to (is referred to by)

Domain:

[E89](#) Propositional Object

Range:

[E1](#) CRM Entity

Superproperty of:

[E29](#) Design or Procedure. [P68](#) foresees use of (use foreseen by): [E57](#) Material

E31 Document. P70 documents (is documented in): E1 CRM Entity
E32 Authority Document. P71 lists (is listed in): E1 CRM Entity
E89 Propositional Object. P129 is about (is subject of): E1 CRM Entity
E36 Visual Item. P138 represents (has representation): E1 CRM Entity

Quantification:

many to many (0..n..n)

Scope note:

This property documents that an instance of E89 Propositional Object makes a statement about an instance of E1 CRM Entity. *P67* refers to (is referred to by) has the *P67.1 has type* link to an instance of E55 Type. This is intended to allow a more detailed description of the type of reference. This differs from *P129 is about (is subject of)*, which describes the primary subject or subjects of the instance of E89 Propositional Object.

Examples:

- The eBay auction listing of 4th July 2002 (E73) refers to silver cup 232 (E22) has type item for sale (E55). (fictitious)

In First Order Logic:

$P67(x,y) \Rightarrow E89(x)$
 $P67(x,y) \Rightarrow E1(y)$
 $P67(x,y,z) \Rightarrow [P67(x,y) \wedge E55(z)]$

Properties:

P67.1 has type: E55 Type

P68 foresees use of (use foreseen by)

Domain:

E29 Design or Procedure

Range:

E57 Material

Subproperty of:

E89 Propositional Object. *P67* refers to (is referred to by): E1 CRM Entity

Quantification:

many to many (0..n..n)

Scope note:

This property identifies an instance of E57 Material foreseen to be used by an instance of E29 Design or Procedure.

E29 Designs and procedures commonly foresee the use of particular instances of E57 Material. The fabrication of adobe bricks, for example, requires straw, clay and water. This property enables this to be documented.

This property is not intended for the documentation of instances of E57 Materials that were used on a particular occasion when an instance of E29 Design or Procedure was executed.

Examples:

- The procedure for soda glass manufacture (E29) foresees use of soda (E57). (Brooks, 1973)

In First Order Logic:

$P68(x,y) \Rightarrow E29(x)$

$P68(x,y) \Rightarrow E57(y)$
 $P68(x,y) \Rightarrow P67(x,y)$

P69 has association with (is associated with)

Domain:

E29 Design or Procedure

Range:

E29 Design or Procedure

Quantification:

many to many (0,n:0,n)

Scope note:

This property generalises relationships like whole-part, sequence, prerequisite or inspired by between instances of E29 Design or Procedure. Any instance of E29 Design or Procedure may be associated with other designs or procedures. The property is considered to be symmetrical unless otherwise indicated by *P69.1 has type*. The property is not transitive

The *P69.1 has type* property of *P69 has association with* allows the nature of the association to be specified reading from domain to range; examples of types of association between instances of E29 Design or Procedure include: has part, follows, requires, etc.

The property can typically be used to model the decomposition of the description of a complete workflow into a series of separate procedures.

Examples:

- The procedure for glass blowing (E29) *has association with* the procedure for glass heating (E29). (Brooks, 1973)
- The set of instructions for performing Macbeth in Max Reinhardt's production in 1916 in Berlin at Deutsches Theater (E29) *has association with* the scene design drawing by Ernst Stern reproduced at <http://www.glopad.org/pi/fr/record/digdoc/1003814> (E29) *has type* has part (E55).
- The preparation of parchment (E29) *has association with* soaking and unhairing of skin (E29) *has type* has part (E55).
- Stretching of skin (E29) *has association with* soaking and unhairing of skin (E29) *has type* follows (E55). (Poole and Reed, 1962)
- The plan for reassembling the temples at Abu Simbel (E29) *has association with* the plan for storing and transporting the blocks (E29) *has type* follows (E55). (Loubiere, 1995)

In First Order Logic:

$P69(x,y) \Rightarrow E29(x)$
 $P69(x,y) \Rightarrow E29(y)$
 $P69(x,y,z) \Rightarrow [P69(x,y) \wedge E55(z)]$

Properties:

P69.1 has type: E55 Type

P70 documents (is documented in)

Domain:

E31 Document

Range:

E1 CRM Entity

Subproperty of:

E89 Propositional Object. P67 refers to (is referred to by): E1 CRM Entity

Quantification:

many to many, necessary (1,n:0,n)

Scope note:

This property describes the CRM Entities documented as instances of E31 Document.

Documents may describe any conceivable entity, hence the link to the highest-level entity in the CIDOC CRM class hierarchy. This property is intended for cases where a reference is regarded as making a proposition about reality. This may be of a documentary character, in the scholarly or scientific sense, or a more general statement.

Examples:

- The 'Catalogue of the Greek coins of Arabia, Mesopotamia and Persia' (E31) *documents* parts of the British Museum's Collection (E78). (British Museum & Hill, 1922)

In First Order Logic:

$P70(x,y) \Rightarrow E31(x)$
 $P70(x,y) \Rightarrow E1(y)$
 $P70(x,y) \Rightarrow P67(x,y)$

P71 lists (is listed in)

Domain:

E32 Authority Document

Range:

E1 CRM Entity

Subproperty of:

E89 Propositional Object. P67 refers to (is referred to by): E1 CRM Entity

Quantification:

many to many (0,n:0,n)

Scope note:

This property associates an instance of E32 Authority Document, with an instance of E1 CRM Entity which it lists for reference purposes.

Examples:

- The Art & Architecture Thesaurus (E32) *lists* alcazars (E55). (<http://vocab.getty.edu/page/aat/300006897>)

In First Order Logic:

$P71(x,y) \Rightarrow E32(x)$
 $P71(x,y) \Rightarrow E1(y)$
 $P71(x,y) \Rightarrow P67(x,y)$

P72 has language (is language of)

Domain:

E33 Linguistic Object

Range:

E56 Language

Quantification:

many to many, necessary (1,n:0,n)

Scope note:

This property associates an instance(s) of E33 Linguistic Object with an instance of E56 Language in which it is, at least partially, expressed.

Linguistic Objects are composed in one or more human Languages. This property allows these languages to be documented.

Examples:

- The American Declaration of Independence (E33) *has language* 18th Century English (E56). (Perley, 2017)

In First Order Logic:

$P72(x,y) \Rightarrow E33(x)$

$P72(x,y) \Rightarrow E56(y)$

P73 has translation (is translation of)

Domain:

E33 Linguistic Object

Range:

E33 Linguistic Object

Subproperty of:

E70 Thing. P130i features are also found on: E70 Thing

Quantification:

many to many (0,n:0,n)

Scope note:

This property links an instance of E33 Linguistic Object (A), to another instance of E33 Linguistic Object (B) which is the translation of A.

When an instance of E33 Linguistic Object is translated into a new language a new instance of E33 Linguistic Object is created, despite the translation being conceptually similar to the source.

This property is non-symmetric.

Examples:

- “Les Baigneurs” (E33) *has translation* “The Bathers” (E33). (Spiers & Surene, 1854)

In First Order Logic:

$P73(x,y) \Rightarrow E33(x)$

$P73(x,y) \Rightarrow E33(y)$

$P73(x,y) \Rightarrow P130i(x,y)$

$P73(x,y) \Rightarrow \neg P73(y,x)$

P74 has current or former residence (is current or former residence of)

Domain:

E39 Actor

Range:

E53 Place

Quantification:

many to many (0,n:0,n)

Scope note:

This property describes the current or former place of residence (an instance of E53 Place) of an instance of E39 Actor.

The residence may be either the place where the actor resides, or a legally registered address of any kind.

Examples:

- Queen Elizabeth II (E39) *has current or former residence* Buckingham Palace (E53). (Robinson, 2000)

In First Order Logic:

$P74(x,y) \Rightarrow E39(x)$

$P74(x,y) \Rightarrow E53(y)$

P75 possesses (is possessed by)

Domain:

E39 Actor

Range:

E30 Right

Quantification:

many to many (0,n:0,n)

Scope note:

This property associates an instance of E39 Actor to an instance of E30 Right over which the actor holds or has held a legal claim.

Examples:

- Michael Jackson (E21) *possesses* Intellectual property rights on the Beatles' back catalogue (E30). (Raga, 2016)

In First Order Logic:

$P75(x,y) \Rightarrow E39(x)$

$P75(x,y) \Rightarrow E30(y)$

P76 has contact point (provides access to)

Domain:

E39 Actor

Range:

E41 Appellation

Quantification:

many to many (0,n:0,n)

Scope note:

This property associates an instance of E39 Actor to an instance of E41 Appellation which a communication service uses to direct communications to this actor, such as an e-mail address, fax number, or postal address.

Examples:

- The Research Libraries Group, Inc. (RLG) (E74) *has contact point* “bl.ric@rlg.org” (E41)

In First Order Logic:

$P76(x,y) \Rightarrow E39(x)$

$P76(x,y) \Rightarrow E41(y)$

P79 beginning is qualified by

Domain:

E52 Time-Span

Range:

E62 String

Subproperty of:

E1 CRM Entity. P3 has note: E62 String

Quantification:

many to one (0,1:0,n)

Scope note:

This property associates an instance of E52 Time-Span with a note detailing the scholarly or scientific opinions and justifications about the certainty, precision, sources etc. of its beginning. Such notes may also be used to elaborate arguments about constraints or to give explanations of alternatives.

Examples:

- The time-span of the Holocene (E52) *beginning is qualified by* “The formal definition and dating of the GSSP (GlobalStratotype Section and Point) for the base of the Holocene using the Greenland NGRIP ice core, and selected auxiliary records” (E62). (Walker et al., 2009)

In First Order Logic:

$P79(x,y) \Rightarrow E52(x)$

$P79(x,y) \Rightarrow E62(y)$

$P79(x,y) \Rightarrow P3(x,y)$

P80 end is qualified by

Domain:

[E52](#) Time-Span

Range:

[E62](#) String

Subproperty of:

[E1](#) CRM Entity. [P3](#) has note: [E62](#) String

Quantification:

many to one (0,1:0,n)

Scope note:

This property associates an instance of [E52](#) Time-Span with a note detailing the scholarly or scientific opinions and justifications about the end of this time-span concerning certainty, precision, sources etc. This property may also be used to describe arguments constraining possible dates and to distinguish reasons for alternative dates.

Examples:

- The time-span of the Holocene ([E52](#)) *end is qualified by* “still ongoing” ([E62](#)). (Walker et al., 2009)

In First Order Logic:

$P80(x,y) \Rightarrow E52(x)$

$P80(x,y) \Rightarrow E62(y)$

$P80(x,y) \Rightarrow P3(x,y)$

P81 ongoing throughout

Domain:

[E52](#) Time-Span

Range:

[E61](#) Time Primitive

Quantification:

many to one, necessary (1,n:0,n)

Scope note:

This property associates an instance of [E52](#) Time-Span with an instance of [E61](#) Time Primitive specifying a minimum period of time covered by it. Since Time-Spans may not have precisely known temporal extents, the CIDOC CRM supports statements about the minimum and maximum temporal extents of Time-Spans. This property allows a Time-Span's minimum temporal extent (i.e., its inner boundary) to be assigned an [E61](#) Time Primitive value. Time Primitives are treated by the CIDOC CRM as application or system specific date intervals, and are not further analysed. If different sources of evidence justify different minimum extents without contradicting each other, the smallest interval including all these extents will be the best estimate. This should be taken into account for information integration.

Examples:

- The time-span of the development of the CIDOC CRM ([E52](#)) *ongoing throughout* “1996-2003” ([E61](#)). (Doerr, 2003)
- The Time-Span of the Thirty Years War ([E52](#)) *ongoing throughout* “23rd May 1618 AD until 24th October 1648 AD” ([E61](#)). (Bonney, 2014)

- The time-span of the First Intermediate Period of Ancient Egypt (7th to 10th dynasty) (E52) *ongoing throughout* “2181 BC – 2160 BC” (E61). (Reid, 1993)
[This is the minimal common agreement of two conflicting dates: James Henry Breasted dates the First Intermediate Period of Ancient Egypt (7th to 10th dynasty) from 2475BC to 2160BC in his *Ancient Records* (first published in 1906), volume 1, sections 58–75 (Breasted, 1906). Ian Shaw dates it from 2181BC to 2125BC in his *Oxford History of Ancient Egypt* (published in 2000), pp. 479–483 (Shaw, 2000).]

In First Order Logic:

$P81(x,y) \Rightarrow E52(x)$

$P81(x,y) \Rightarrow E61(y)$

P82 at some time within

Domain:

E52 Time-Span

Range:

E61 Time Primitive

Quantification:

many to many, necessary (1,n:0,n)

Scope note:

This property describes the maximum period of time within which an E52 Time-Span falls. Since Time-Spans may not have precisely known temporal extents, the CIDOC CRM supports statements about the minimum and maximum temporal extents of Time-Spans. This property allows a Time-Span’s maximum temporal extent (i.e., its outer boundary) to be assigned an E61 Time Primitive value. Time Primitives are treated by the CIDOC CRM as application or system specific date intervals, and are not further analysed. If different sources of evidence justify different maximum extents without contradicting each other, the resulting intersection of all these extents will be the best estimate. This should be taken into account for information integration.

Examples:

- The time-span of the development of the CIDOC CRM (E52) *at some time within* “1992-infinity” (E61). (Doerr, 2003)
- The Time-Span of the Battle in the Teutoburg Forest (E52) *at some time within* “September 9 CE” (E61). (Andrews & Kesteven, 1977)
- The time-Span of the death of Tut Ankh Amun (E52) *at some time within* “December 1324 BC to February 1323 BC” (E61). (Murdoch, 2003)
- The time-span of the First Intermediate Period of Ancient Egypt (7th to 10th dynasty) (E52) *at some time within* “2475BC - 2125BC” (E61). (Reid, 1993)

In First Order Logic:

$P82(x,y) \Rightarrow E52(x)$

$P82(x,y) \Rightarrow E61(y)$

P86 falls within (contains)

Domain:

E52 Time-Span

Range:

E52 Time-Span

Quantification:

many to many (0,n:0,n)

Scope note:

This property describes the inclusion relationship between two instances of E52 Time-Span.

This property supports the notion that the temporal extent of an instance of E52 Time-Span falls within the temporal extent of another instance of E52 Time-Span. It addresses temporal containment only, and no contextual link between the two instances of E52 Time-Span is implied. This property is transitive.

Examples:

- The time-span of the Apollo 11 moon mission (E52) *falls within* the time-span of the reign of Queen Elizabeth II (E52). (Riley, 2009) (Robinson, 2000)

In First Order Logic:

$P86(x,y) \Rightarrow E52(x)$

$P86(x,y) \Rightarrow E52(y)$

$[P86(x,y) \wedge P86(y,z)] \Rightarrow P86(x,z)$

P89 falls within (contains)

Domain:

E53 Place

Range:

E53 Place

Quantification:

many to many, necessary, dependent (1,n:0,n)

Scope note:

This property identifies an instance of E53 Place that falls wholly within the extent of another instance of E53 Place.

It addresses spatial containment only and does not imply any relationship between things or phenomena occupying these places.

This property is transitive and reflexive.

Examples:

- The area covered by the World Heritage Site of Stonehenge (E53) *falls within* the area of Salisbury Plain (E53). (Pryor, 2016)

In First Order Logic:

$P89(x,y) \Rightarrow E53(x)$

$P89(x,y) \Rightarrow E53(y)$

$[P89(x,y) \wedge P89(y,z)] \Rightarrow P89(x,z)$

P89(x,x)

P90 has value

Domain:

E54 Dimension

Range:

E60 Number

Quantification:

many to one, necessary (1,1:0,n)

Scope note:

This property allows an instance of E54 Dimension to be approximated by an instance of E60 Number primitive.

Examples:

- The height of silver cup 232 (E54) *has value* 226 (E60). (fictitious)
- Christie's hammer price for Vincent van Gogh's "Still Life: Vase with Fifteen Sunflowers" in London on 30th March 1987 (E97) *has value* 24,750,000 (E60).

In First Order Logic:

$P90(x,y) \Rightarrow E54(x)$

$P90(x,y) \Rightarrow E60(y)$

P91 has unit (is unit of)

Domain:

E54 Dimension

Range:

E58 Measurement Unit

Superproperty of:

E97 Monetary Amount. P180 has currency: E98 Currency

Quantification:

many to one, necessary (1,1:0,n)

Scope note:

This property shows the type of unit an instance of E54 Dimension was expressed in.

Examples:

- The height of silver cup 232 (E54) *has unit* mm (E58). (fictitious)

In First Order Logic:

$P91(x,y) \Rightarrow E54(x)$

$P91(x,y) \Rightarrow E58(y)$

P92 brought into existence (was brought into existence by)

Domain:

E63 Beginning of Existence

Range:

E77 Persistent Item

Subproperty of:

E5 Event. P12 occurred in the presence of (was present at): E77 Persistent Item

Superproperty of:

E65 Creation. P94 has created (was created by): E28 Conceptual Object

E66 Formation. P95 has formed (was formed by): E74 Group

E67 Birth. P98 brought into life (was born): E21 Person

E12 Production. P108 has produced (was produced by): E24 Physical Human-Made Thing

E81 Transformation. P123 resulted in (resulted from): E18 Physical Thing

Quantification:

one to many, necessary, dependent (1,n:1,1)

Scope note:

This property links an instance of E63 Beginning of Existence to the instance of E77 Persistent Item brought into existence by it.

It allows a “start” to be attached to any instance of E77 Persistent Item being documented, i.e., as instances of E70 Thing, E72 Legal Object, E39 Actor, E41 Appellation and E55 Type.

Examples:

• The birth of Mozart (E67) *brought into existence* Mozart (E21). (Deutsch, 1965)

In First Order Logic:

$P92(x,y) \Rightarrow E63(x)$

$P92(x,y) \Rightarrow E77(y)$

$P92(x,y) \Rightarrow P12(x,y)$

P93 took out of existence (was taken out of existence by)

Domain:

E64 End of Existence

Range:

E77 Persistent Item

Subproperty of:

E5 Event. P12 occurred in the presence of (was present at): E77 Persistent Item

Superproperty of:

E6 Destruction. P13 destroyed (was destroyed by): E18 Physical Thing

E68 Dissolution. P99 dissolved (was dissolved by): E74 Group

E69 Death. P100 was death of (died in): E21 Person

E81 Transformation. P124 transformed (was transformed by): E18 Physical Thing

Quantification:

one to many, necessary (1,n:0,1)

Scope note:

This property links an instance of E64 End of Existence to the instance of E77 Persistent Item taken out of existence by it.

In the case of immaterial things, the instance of E64 End of Existence is considered to take place with the destruction of the last physical carrier.

This allows an “end” to be attached to any instance of E77 Persistent Item being documented i.e., instances of E70 Thing, E72 Legal Object, E39 Actor, E41 Appellation and E55 Type. For

many instances of E77 Persistent Item we know the maximum life-span and can infer that they must have ended to exist. We assume in that case an instance of E64 End of Existence, which may be as unnoticeable as forgetting the secret knowledge by the last representative of some indigenous nation.

Examples:

- The death of Mozart (E69) *took out of existence* Mozart (E21). (Deutsch, 1965)

In First Order Logic:

$P93(x,y) \Rightarrow E64(x)$
 $P93(x,y) \Rightarrow E77(y)$
 $P93(x,y) \Rightarrow P12(x,y)$

P94 has created (was created by)

Domain:

E65 Creation

Range:

E28 Conceptual Object

Subproperty of:

E63 Beginning of Existence. P92 brought into existence (was brought into existence by): E77 Persistent Item

Superproperty of:

E83 Type Creation. P135 created type (was created by): E55 Type

Quantification:

one to many, necessary, dependent (1,n:1,1)

Scope note:

This property links an instance of E65 Creation to the instance of E28 Conceptual Object created by it.

It represents the act of conceiving the intellectual content of the instance of E28 Conceptual Object. It does not represent the act of creating the first physical carrier of the instance of E28 Conceptual Object. As an example, this is the composition of a poem, not its commitment to paper.

Examples:

- The composition of “The Four Friends” by A. A. Milne (E65) *has created* “The Four Friends” by A. A. Milne (E33). (Milne, 2012)

In First Order Logic:

$P94(x,y) \Rightarrow E65(x)$
 $P94(x,y) \Rightarrow E28(y)$
 $P94(x,y) \Rightarrow P92(x,y)$

P95 has formed (was formed by)

Domain:

[E66](#) Formation

Range:

[E74](#) Group

Subproperty of:

[E63](#) Beginning of Existence. [P92](#) brought into existence (was brought into existence by): [E77](#) Persistent Item

Quantification:

one to many, necessary, dependent (1,n:1,1)

Scope note:

This property associates the instance of [E66](#) Formation with the instance of [E74](#) Group that it founded.

Examples:

- The formation of the CIDOC CRM SIG at the August 2000 CIDOC Board meeting ([E66](#)) *has formed* the CIDOC CRM Special Interest Group ([E74](#)).

In First Order Logic:

$P95(x,y) \Rightarrow E66(x)$

$P95(x,y) \Rightarrow E74(y)$

$P95(x,y) \Rightarrow P92(x,y)$

P96 by mother (gave birth)

Domain:

[E67](#) Birth

Range:

[E21](#) Person

Subproperty of:

[E5](#) Event. [P11](#) had participant (participated in): [E39](#) Actor

Quantification:

many to one, necessary (1,1:0,n)

Scope note:

This property links an instance of [E67](#) Birth to an instance of [E21](#) Person in the role of birth-giving mother.

Note that biological fathers are not necessarily participants in the Birth (see *P97 from father (was father for)*). The instance of [E21](#) Person being born is linked to the instance of [E67](#) Birth with the property *P98 brought into life (was born)*. This is not intended for use with general natural history material, only people. There is no explicit method for modelling conception and gestation except by using extensions.

Examples:

- The birth of Queen Elizabeth II ([E67](#)) *by mother* Her Majesty Queen Elizabeth The Queen Mother ([E21](#)). (Parker, 2002)

In First Order Logic:

$P96(x,y) \Rightarrow E67(x)$
 $P96(x,y) \Rightarrow E21(y)$
 $P96(x,y) \Rightarrow P11(x,y)$

P97 from father (was father for)

Domain:

E67 Birth

Range:

E21 Person

Quantification:

many to one, necessary (1,1:0,n)

Scope note:

This property links an instance of E67 Birth to an instance of E21 Person in the role of biological father.

Note that biological fathers are not seen as necessary participants in the birth, whereas birth-giving mothers are (see *P96 by mother (gave birth)*). The Person being born is linked to the Birth with the property *P98 brought into life (was born)*.

This is not intended for use with general natural history material, only people. There is no explicit method for modelling conception and gestation except by using extensions.

An instance of E67 Birth is normally (but not always) associated with one biological father.

Examples:

• King George VI (E21) *was father for* the birth of Queen Elizabeth II (E67). (Parker, 2002)

In First Order Logic:

$P97(x,y) \Rightarrow E67(x)$
 $P97(x,y) \Rightarrow E21(y)$

P98 brought into life (was born)

Domain:

E67 Birth

Range:

E21 Person

Subproperty of:

E63 Beginning of Existence. P92 brought into existence (was brought into existence by): E77 Persistent Item

Quantification:

one to many, dependent (0,n:1,1)

Scope note:

This property links an instance of E67 Birth event to an instance of E21 Person in the role of offspring.

Twins, triplets etc. are brought into life by the same instance of E67 Birth. This is not intended for use with general Natural History material, only people. There is no explicit method for modelling conception and gestation except by using extensions.

Examples:

- The Birth of Queen Elizabeth II (E67) *brought into life* Queen Elizabeth II (E21). (Parker, 2002)

In First Order Logic:

$P98(x,y) \Rightarrow E67(x)$
 $P98(x,y) \Rightarrow E21(y)$
 $P98(x,y) \Rightarrow P92(x,y)$

P99 dissolved (was dissolved by)

Domain:

E68 Dissolution

Range:

E74 Group

Subproperty of:

E5 Event. P11 had participant (participated in): E39 Actor
E64 End of Existence. P93 took out of existence (was taken out of existence by): E77
Persistent Item

Quantification:

one to many, necessary (1,n:0,n)

Scope note:

This property associates the instance of E68 Dissolution with the instance of E74 Group that it disbanded.

Examples:

- The end of The Hole in the Wall Gang (E68) *dissolved* The Hole in the Wall Gang (E74). (Patterson, 1998)

In First Order Logic:

$P99(x,y) \Rightarrow E68(x)$
 $P99(x,y) \Rightarrow E74(y)$
 $P99(x,y) \Rightarrow P11(x,y)$
 $P99(x,y) \Rightarrow P93(x,y)$

P100 was death of (died in)

Domain:

E69 Death

Range:

E21 Person

Subproperty of:

E64 End of Existence. P93 took out of existence (was taken out of existence by): E77
Persistent Item

Quantification:

one to many, necessary (1,n:0,1)

Scope note:

This property links an instance of E69 Death to the instance of E21 Person that died.

An instance of E69 Death may involve multiple people, for example in the case of a battle or disaster.

This is not intended for use with general natural history material, only people.

Examples:

- Mozart's death (E69) was death of Mozart (E21). (Sitwell, 2017)

In First Order Logic:

$P100(x,y) \Rightarrow E69(x)$

$P100(x,y) \Rightarrow E21(y)$

$P100(x,y) \Rightarrow P93(x,y)$

P101 had as general use (was use of)

Domain:

E70 Thing

Range:

E55 Type

Quantification:

many to many (0,n:0,n)

Scope note:

This property associates an instance of E70 Thing with an instance of E55 Type that describes the type of use that it was actually employed for.

It allows the relationship between particular things, both physical and immaterial, and the general methods and techniques of real use to be documented. This may well be different from the intended functional purpose of the instance of E70 Thing (which can be documented with *P103 was intended for (was intention of)*). For example, it could be recorded that a particular wooden crate had a general use as a shelf support on a market stall even though it had been originally intended for carrying vegetables.

The use of this property is intended to allow the documentation of usage patterns attested in historical records or through scientific investigation (for instance ceramic residue analysis). It should not be used to document the intended, and thus assumed, use of an object.

Examples:

- Tony Gill's Ford Mustang (E22) had as general use transportation (E55).
- The Egyptian unglazed vessel used in the 2003 study reported by Barnard et al. (E22) had as general use camel milk preparation (E55). (Barnard et al., 2007)

In First Order Logic:

$P101(x,y) \Rightarrow E70(x)$

$P101(x,y) \Rightarrow E55(y)$

$P101(x,y) \Rightarrow (\exists z)[E7(z) \wedge P16i(x,z) \wedge P2(z,y)]$

P102 has title (is title of)

Domain:

E71 Human-Made Thing

Range:

E35 Title

Subproperty of:

E1 CRM Entity. P1 is identified by (identifies): E41 Appellation

Quantification:

many to many (0,n:0,n)

Scope note:

This property associates an instance of E35 Title has been applied to an instance of E71 Human-Made Thing.

The *P102.1 has type* property of the *P102 has title (is title of)* property enables the relationship between the title and the thing to be further clarified, for example, if the title was a given title, a supplied title etc.

It allows any human-made material or immaterial thing to be given a title. It is possible to imagine a title being created without a specific object in mind.

Examples:

- The first book of the Old Testament (E33) *has title* "Genesis" (E35) *has type* translated title (E55) (E55). (Brueggemann, 1982)
- Monet's painting from 1868-1869 held by Musée d'Orsay, Paris, under inventory number RF 1984 164 (E22) *has title* "La Pie" (E35) *has type* creator's title (E55). (Musée d'Orsay, 2020)
- Monet's painting from 1868-1869 held by Musée d'Orsay, Paris, under inventory number RF 1984 164 (E22) *has title* "The Magpie" (E35) *has type* translated title (E55). (Musée d'Orsay, 2020)

In First Order Logic:

$P102(x,y) \Rightarrow E71(x)$

$P102(x,y) \Rightarrow E35(y)$

$P102(x,y,z) \Rightarrow [P102(x,y) \wedge E55(z)]$

$P102(x,y) \Rightarrow P1(x,y)$

Properties:

P102.1 has type: E55 Type

P103 was intended for (was intention of)

Domain:

E71 Human-Made Thing

Range:

E55 Type

Quantification:

many to many (0,n:0,n)

Scope note:

This property links an instance of E71 Human-Made Thing to an instance of E55 Type describing its intended usage.

It creates a relation between specific human-made things, both physical and immaterial, to types of intended methods and techniques of use. Note: A link between specific human-made things and a specific use activity should be expressed using *P19 was intended use of (was made for)*.

Examples:

- This plate (E22) *was intended for* being destroyed at wedding reception (E55). (fictitious)

In First Order Logic:

$P103(x,y) \Rightarrow E71(x)$

$P103(x,y) \Rightarrow E55(y)$

P104 is subject to (applies to)

Domain:

E72 Legal Object

Range:

E30 Right

Quantification:

many to many (0,n:0,n)

Scope note:

This property links a particular instance of E72 Legal Object to the instances of E30 Right to which it is subject.

The Right is held by an E39 Actor as described by *P75 possesses (is possessed by)*.

Examples:

- The Beatles back catalogue (E89) *is subject to* reproduction right on the Beatles back catalogue (E30). (Raga, 2016)

In First Order Logic:

$P104(x,y) \Rightarrow E72(x)$

$P104(x,y) \Rightarrow E30(y)$

P105 right held by (has right on)

Domain:

E72 Legal Object

Range:

E39 Actor

Superproperty of:

E18 Physical Thing. P52 has current owner (is current owner of): E39 Actor

Quantification:

many to many (0,n:0,n)

Scope note:

This property identifies the instance of E39 Actor who holds the instances of E30 Right to an instance of E72 Legal Object.

It is a superproperty of *P52 has current owner (is current owner of)* because ownership is a right that is held on the owned object.

This property is a shortcut of the fully developed path from E72 Legal Object, *P104 is subject to*, E30 Right, *P75i is possessed by* to E39 Actor.

Examples:

- The Beatles back catalogue (E73) *right held by* Michael Jackson (E21). (Raga, 2016)

In First Order Logic:

$P105(x,y) \Rightarrow E72(x)$

$P105(x,y) \Rightarrow E39(y)$

$P105(x,y) \Leftarrow (\exists z) [E30(z) \wedge P104(x,z) \wedge P75i(z,y)]$

P106 is composed of (forms part of)

Domain:

E90 Symbolic Object

Range:

E90 Symbolic Object

Superproperty of:

E73 Information Object. P165 incorporates (is incorporated in): E90 Symbolic Object

Quantification:

many to many (0,n:0,n)

Scope note:

This property associates an instance of E90 Symbolic Object with a part of it that is by itself an instance of E90 Symbolic Object, such as fragments of texts or clippings from an image.

This property is transitive and non-reflexive.

Examples:

- This Scope note of property P106 (E33) *is composed of* 'fragments of texts' (E33).
- 'recognizable' (E90) *is composed of* 'recognizable' (E90).

In First Order Logic:

$P106(x,y) \Rightarrow E90(x)$

$P106(x,y) \Rightarrow E90(y)$

$[P106(x,y) \wedge P106(y,z)] \Rightarrow P106(x,z)$

$\neg P106(x,x)$

P107 has current or former member (is current or former member of)

Domain:

E74 Group

Range:

E39 Actor

Quantification:

many to many (0,n:0,n)

Scope note:

This property associates an instance of E74 Group with an instance of E39 Actor that is or has been a member thereof.

Instances of E74 Group and E21 Person_r may all be members of instances of E74 Group. An instance of E74 Group may be founded initially without any member.

This property is a shortcut of the more fully developed path from E74 Group, *P144i gained member by*, E85 Joining, *P143 joined to* E39 Actor.

The property P107.1 *kind of member* can be used to specify the type of membership or the role the member has in the group.

Examples:

- Moholy-Nagy (E21) *is current or former member of* Bauhaus (E74). (Moholy-Nagy, 2012)
- National Museum of Science and Industry (E74) *has current or former member* The National Railway Museum (E74). (Rolt, 1971)
- The married couple Queen Elisabeth and Prince Phillip (E74) *has current or former member* Prince Phillip (E21) *kind of member* husband (E55). (Brandreth, 2004)

In First Order Logic:

$P107(x,y) \Rightarrow E74(x)$
 $P107(x,y) \Rightarrow E39(y)$
 $P107(x,y,z) \Rightarrow [P107(x,y) \wedge E55(z)]$
 $P107(x,y) \Leftarrow (\exists z) [E85(z) \wedge P144i(x,z) \wedge P143(z,y)]$

Properties:

P107.1 *kind of member*: E55 Type

P108 has produced (was produced by)

Domain:

E12 Production

Range:

E24 Physical Human-Made Thing

Subproperty of:

E11 Modification. P31 has modified (was modified by): E18 Physical Thing
E63 Beginning of Existence. P92 brought into existence (was brought into existence by): E77 Persistent Item

Quantification:

one to many, necessary, dependent (1,n:1,1)

Scope note:

This property identifies the instance of E24 Physical Human-Made Thing that came into existence as a result of the instance of E12 Production.

The identity of an instance of E24 Physical Human-Made Thing is not defined by its matter, but by its existence as a subject of documentation. An E12 Production can result in the creation of multiple instances of E24 Physical Human-Made Thing.

Examples:

- The building of Rome (E12) *has produced* The Colosseum (E24). (Hopkins & Beard, 2011)

In First Order Logic:

$P108(x,y) \Rightarrow E12(x)$
 $P108(x,y) \Rightarrow E24(y)$
 $P108(x,y) \Rightarrow P31(x,y)$
 $P108(x,y) \Rightarrow P92(x,y)$

P109 has current or former curator (is current or former curator of)

Domain:

E78 Curated Holding

Range:

E39 Actor

Subproperty of:

E18 Physical Thing. P49 has former or current keeper (is former or current keeper of): E39 Actor

Quantification:

many to many, necessary (1,n:0,n)

Scope note:

This property identifies the instance of E39 Actor who assumed or have assumed overall curatorial responsibility for an instance of E78 Curated Holding.

It does not allow a history of curation to be recorded. This would require use of an event initiating a curator being responsible for a collection.

Examples:

- The Robert Opie Collection (E78) *has current or former curator* Robert Opie (E21). (<https://www.robertopiecollection.com/>)
- The Mikael Heggelund Foslie's coralline red algae Herbarium (E78) *has current or former curator* Mikael Heggelund Foslie (E21). (Woelkerling et al., 2005)

In First Order Logic:

$P109(x,y) \Rightarrow E78(x)$

$P109(x,y) \Rightarrow E39(y)$

$P109(x,y) \Rightarrow P49(x,y)$

P110 augmented (was augmented by)

Domain:

E79 Part Addition

Range:

~~E24~~ E18 Physical Human-Made Thing

Subproperty of:

E11 Modification. P31 has modified (was modified by): E18 Physical Thing

Quantification:

many to many, necessary (1,n:0,n)

Scope note:

This property identifies the instance of E24 Physical Human-Made Thing that is added to (augmented) in an instance of E79 Part Addition.

Although an instance of E79 Part Addition event normally concerns only one instance of E24 Physical Human-Made Thing, it is possible to imagine circumstances under which more than one item might be added to (augmented). For example, the artist Jackson Pollock trailing paint onto multiple canvasses.

Examples:

- The final nail-insertion Event (E79) *augmented* Coffin of George VI (E22).
(<https://www.rct.uk/collection/2000811/the-coffin-of-king-george-vi-during-the-lying-in-state>)
- [The attachment of the bronze hand of the Alpi Maritime sculpture \(E79\) augmented the tree of the Alpi Maritime sculpture \(E20\)](https://giuseppenone.com/en/words/maritime-alps). [<https://giuseppenone.com/en/words/maritime-alps>] (Mangini, 2010)

In First Order Logic:

$P110(x,y) \Rightarrow E79(x)$
 $P110(x,y) \Rightarrow E24E18(y)$
 $P110(x,y) \Rightarrow P31(x,y)$

P111 added (was added by)

Domain:

[E79](#) Part Addition

Range:

[E18](#) Physical Thing

Subproperty of:

[E7](#) Activity. [P16](#) used specific object (was used for): [E70](#) Thing

Quantification:

many to many, necessary (1,n:0,n)

Scope note:

This property identifies the instance of [E18](#) Physical Thing that is added during an instance of [E79](#) Part Addition activity

Examples:

- The insertion of the final nail (E79) *added* the last nail in George VI's coffin (E22).
(<https://www.rct.uk/collection/2000811/the-coffin-of-king-george-vi-during-the-lying-in-state>)

In First Order Logic:

$P111(x,y) \Rightarrow E79(x)$
 $P111(x,y) \Rightarrow E18(y)$
 $P111(x,y) \Rightarrow P16(x,y)$

P112 diminished (was diminished by)

Domain:

[E80](#) Part Removal

Range:

~~[E24](#) Physical Human-Made Thing~~[E18](#) Physical Thing

Subproperty of:

[E11](#) Modification. [P31](#) has modified (was modified by): [E18](#) Physical Thing

Quantification:

many to many, necessary (1,n:0,n)

Formatted: Hyperlink

Scope note:

~~This property identifies the instance of E18 Physical Thing that was diminished by an instance of E80 Part Removal.~~

~~Although an instance of E80 Part removal activity normally concerns only one instance of E18 Physical Thing, it is possible to imagine circumstances under which more than one item might be diminished by a single instance of E80 Part Removal activity. This property identifies the instance E24 Physical Human-Made Thing that was diminished by an instance of E80 Part Removal.~~

~~Although an instance of E80 Part removal activity normally concerns only one instance of E24 Physical Human-Made Thing, it is possible to imagine circumstances under which more than one item might be diminished by a single instance of E80 Part Removal activity.~~

Examples:

- The coffin of Tut-Ankh-Amun (E22) *was diminished by* The opening of the coffin of Tut-Ankh-Amun (E80). (Carter, 2014)
- The coral of the Cocos Islands (E20) *was diminished by* The removal of the Porite coral specimen by Charles Darwin (E80). (Natural History Museum, 2010, b)

In First Order Logic:

$P112(x,y) \Rightarrow E80(x)$
 $P112(x,y) \Rightarrow E24E18(y)$
 $P112(x,y) \Rightarrow P31(x,y)$

P113 removed (was removed by)

Domain:

E80 Part Removal

Range:

E18 Physical Thing

Subproperty of:

E5 Event. P12 occurred in the presence of (was present at): E77 Persistent Item

Quantification:

many to many, necessary (1,n:0,n)

Scope note:

This property identifies the instance of E18 Physical Thing that is removed during an instance of E80 Part Removal activity.

Examples:

- The opening of the coffin of Tut-Ankh-Amun (E80) *removed* The mummy of Tut-Ankh-Amun (E20, E22). (Carter, 2014)

In First Order Logic:

$P113(x,y) \Rightarrow E80(x)$
 $P113(x,y) \Rightarrow E18(y)$
 $P113(x,y) \Rightarrow P12(x,y)$

P121 overlaps with

Domain:

E53 Place

Range:

E53 Place

Quantification:

many to many (0,n:0,n)

Scope note:

This symmetric property associates an instance of E53 Place with another instance of E53 Place geometrically overlapping it.

It does not specify anything about the shared area. This property is purely spatial. It does not imply that phenomena that define, by their extent, places related by *P121 overlaps with* have ever covered a common area at the same time or even coexisted. In contrast, spatiotemporal overlaps described by *P132 spatiotemporally overlaps* are the total of areas simultaneously covered by the related spacetime volumes.

This property is symmetric.

Examples:

- The territory of the United States as in 2020 (E53) *overlaps with* the Arctic (E53). (Gannett et al., 1904)
- The maximal extent of the Kingdom of Greece (1832-1973) (E53) *overlaps with* the maximal extent of the Republic of Turkey (29th October 1923 to now) (E53).

In First Order Logic:

$P121(x,y) \Rightarrow E53(x)$

$P121(x,y) \Rightarrow E53(y)$

$P121(x,y) \Rightarrow P121(y,x)$

P122 borders with

Domain:

E53 Place

Range:

E53 Place

Quantification:

many to many (0,n:0,n)

Scope note:

This symmetric property associates an instance of E53 Place with another instance of E53 Place which shares a part of its border.

This property is purely spatial. It does not imply that the phenomena that define, by their extent, places related by *P122 borders with* have ever shared a respective border at the same time or even coexisted. In particular, this may be the case when the respective common border is formed by a natural feature.

This property is not transitive. This property is symmetric.

Examples:

- Scotland in its 1603 borders (E53) *borders with* England in its 1603 borders (E53). (Crofton, 2015)

In First Order Logic:

$P122(x,y) \Rightarrow E53(x)$

$P122(x,y) \Rightarrow E53(y)$
 $P122(x,y) \Rightarrow P122(y,x)$

P123 resulted in (resulted from)

Domain:

E81 Transformation

Range:

E18 Physical Thing

Subproperty of:

E63 Beginning of Existence. P92 brought into existence (was brought into existence by): E77
Persistent Item

Quantification:

many to many, necessary (1,n:0,n)

Scope note:

This property identifies the instance or instances of E18 Physical Thing that are the result of an instance of E81 Transformation. New items replace the transformed item or items, which cease to exist as units of documentation. The physical continuity between the old and the new is expressed by the links to the common instance of E81 Transformation.

Examples:

- The transformation of the Venetian Loggia in Heraklion into a city hall (E81, E12) *resulted in* the City Hall of Heraklion (E24). [AND: *has produced* (P108) the City Hall of Heraklion (E22)] (Municipality of Heraklion, 2021)
- The mummification of Tut-Ankh-Amun (E81, E12) *resulted in* the Mummy of Tut-Ankh-Amun (E22,E20). [also: *has produced* (P108) the Mummy of Tut-Ankh-Amun (E22,E20).] (Carter & Mace 1977)
- The death, carbonization and petrification of some people of Pompeii in 79AD by the intense heat of a pyroclastic cloud and ashes from the Eruption of Mount Vesuvius (E69, E81) *resulted in* petrified bodies (E20). [Some of these bodies could later be preserved in plaster.]

In First Order Logic:

$P123(x,y) \Rightarrow E81(x)$
 $P123(x,y) \Rightarrow E18(y)$
 $P123(x,y) \Rightarrow P92(x,y)$

P124 transformed (was transformed by)

Domain:

E81 Transformation

Range:

E18 Physical Thing

Subproperty of:

E64 End of Existence. P93 took out of existence (was taken out of existence by): E77
Persistent Item

Quantification:

one to many, necessary (1,n:0,1)

Scope note:

This property identifies the instance or instances E18 Physical Thing that have ceased to exist due to an instance of E81 Transformation.

The item that has ceased to exist and was replaced by the result of the Transformation. The continuity between both items, the new and the old, is expressed by the links to the common instance of E81 Transformation.

Examples:

- The transformation of the Venetian Loggia in Heraklion into a city hall (E81, E12) *transformed* the Venetian Loggia in Heraklion (E24). (Municipality of Heraklion, 2021)
- The mummification of Tut-Ankh-Amun (E81, E12) *transformed* the deceased Pharaoh Tut-Ankh-Amun (E21). (Carter & Mace, 1977)
- The death, carbonization and petrification of some people of Pompeii in 79AD by the intense heat of a pyroclastic cloud and ashes from the Eruption of Mount Vesuvius (E69, E81) *transformed* some people of Pompeii (E21). [AND: *was death of (P108)* some people of Pompeii (E21).]

In First Order Logic:

$P124(x,y) \Rightarrow E81(x)$

$P124(x,y) \Rightarrow E18(y)$

$P124(x,y) \Rightarrow P93(x,y)$

P125 used object of type (was type of object used in)

Domain:

E7 Activity

Range:

E55 Type

Superproperty of:

E7 Activity, P32 used general technique (was technique of): E55 Type

Quantification:

many to many (0,n:0,n)

Scope note:

This property associates an instance of E7 Activity to an instance of E55 Type, which classifies an instance of E70 Thing used in an instance of E7 Activity, when the specific instance is either unknown or not of interest, such as use of "a hammer".

This property is a shortcut of the more fully developed path from E7 Activity through *P16 used specific object*, E70 Thing, *P2 has type*, to E55 Type

Examples:

- The English archers' activity in the Battle of Agincourt (E7) *used object of type* long bow (E55). (Curry, 2015)

In First Order Logic:

$P125(x,y) \Rightarrow E7(x)$

$P125(x,y) \Rightarrow E55(y)$

$P125(x,y) \Leftrightarrow (\exists z) [E70(z) \wedge P16(x,z) \wedge P2(z,y)]$

P126 employed (was employed in)

Domain:

E11 Modification

Range:

E57 Material

Quantification:

many to many (0,n:0,n)

Scope note:

This property identifies the instance of E57 Material employed in an instance of E11 Modification.

The instance of E57 Material used during the instance of E11 Modification does not necessarily become incorporated into the instance of E24 Physical Human-Made Thing that forms the subject of the instance of E11 Modification.

Examples:

- The repairing of the Queen Mary (E11) *employed* Steel (E57). [Beginning October 1942] (Britton, 2012)
- Distilled water (E57) *was employed in* the restoration of the Sistine Chapel (E11). (Pietrangeli, C., 1986)

In First Order Logic:

$P126(x,y) \Rightarrow E11(x)$

$P126(x,y) \Rightarrow E57(y)$

P127 has broader term (has narrower term)

Domain:

E55 Type

Range:

E55 Type

Quantification:

many to many (0,n:0,n)

Scope note:

This property associates an instance of E55 Type with another instance of E55 Type that has a broader meaning.

It allows instances of E55 Types to be organised into hierarchies. This is the sense of "broader term generic (BTG)" as defined in ISO 25964-2:2013 (International Organization for Standardization 2013).

This property is transitive.

Examples:

- dime (E55) *has broader term* coin (E55). (Yerkes, 1989)

In First Order Logic:

$P127(x,y) \Rightarrow E55(x)$

$P127(x,y) \Rightarrow E55(y)$

$[P127(x,y) \wedge P127(y,z)] \Rightarrow P127(x,z)$

P128 carries (is carried by)

Domain:

E18 Physical Thing

Range:

E90 Symbolic Object

Subproperty of:

E70 Thing. P130 shows features of (features are also found on): E70 Thing

Superproperty of:

E24 Physical Human-Made Thing. P65 shows visual item (is shown by): E36 Visual Item

Quantification:

many to many (0,n:0,n)

Scope note:

This property identifies an instance E90 Symbolic Object carried by an instance of E18 Physical Thing. Since an instance of E90 Symbolic Object is defined as an immaterial idealization over potentially multiple carriers, any individual realization on a particular physical carrier may be defective, due to deterioration or shortcomings in the process of creating the realization compared to the intended ideal. As long as such defects do not substantially affect the complete recognition of the respective symbolic object, it is still regarded as carrying an instance of this E90 Symbolic Object. If these defects are of scholarly interest, the particular realization can be modelled as an instance of E25 Human-Made Feature. Note, that any instance of E90 Symbolic Object incorporated (P165) in the carried symbolic object is also carried by the same instance of E18 Physical Thing.

Examples:

- Matthew's paperback copy of Reach for the Sky (E18) *carries* the text of Reach for the Sky (E73). [see also: (Brickhill, 2001)] (fictitious)

In First Order Logic:

$P128(x,y) \Rightarrow E18(x)$

$P128(x,y) \Rightarrow E90(y)$

$P128(x,y) \Rightarrow P130(x,y)$

P129 is about (is subject of)

Domain:

E89 Propositional Object

Range:

E1 CRM Entity

Subproperty of:

E89 Propositional Object. P67 refers to (is referred to by): E1 CRM Entity

Quantification:

many to many (0,n:0,n)

Scope note:

This property documents that an instance of E89 Propositional Object has as subject an instance of E1 CRM Entity.

This differs from *P67 refers to (is referred to by)*, which refers to an instance of E1 CRM Entity, in that it describes the primary subject or subjects of an instance of E89 Propositional Object.

Examples:

- The text entitled 'Reach for the sky' (E33) *is about* Douglas Bader (E21). (Brickhill, 2001)

In First Order Logic:

$P129(x,y) \Rightarrow E89(x)$

$P129(x,y) \Rightarrow E1(y)$

$P129(x,y) \Rightarrow P67(x,y)$

P130 shows features of (features are also found on)

Domain:

E70 Thing

Range:

E70 Thing

Superproperty of:

E33 Linguistic Object. P73i is translation of: E33 Linguistic Object

E18 Physical Thing. P128 carries (is carried by): E90 Symbolic Object

Quantification:

many to many (0,n:0,n)

Scope note:

This property generalises the notions of "copy of" and "similar to" into a directed relationship, where the domain expresses the derivative or influenced item and the range the source or influencing item, if such a direction can be established. The property can also be used to express similarity in cases that can be stated between two objects only, without historical knowledge about its reasons. The property expresses a symmetric relationship in case no direction of influence can be established either from evidence on the item itself or from historical knowledge. This holds in particular for siblings of a derivation process from a common source or non-causal cultural parallels, such as some weaving patterns.

The *P130.1 kind of similarity* property of the *P130 shows features of (features are also found on)* property enables the relationship between the domain and the range to be further clarified, in the sense from domain to range, if applicable. For example, it may be expressed if both items are product "of the same mould", or if two texts "contain identical paragraphs".

If the reason for similarity is a sort of derivation process, i.e., that the creator has used or had in mind the form of a particular thing during the creation or production, this process should be explicitly modelled. In these cases, *P130 shows features of* can be regarded as a shortcut of such a process. However, the current model does not contain any path specific enough to infer this property. Specializations of the CIDOC CRM may however be more explicit, for instance describing the use of moulds etc.

This property is not transitive.

Examples:

- Mary Lamb's *Cymbeline* from Charles and Mary Lamb's *Tales from Shakespeare* (E89) *shows features of* William Shakespeare's *Cymbeline* (E89). (Carrington, 1954)

- The audio recording of Dante Alighieri's La divina commedia read by Enrico de Negri (E73) *shows features of* the text of Dante Alighieri's La divina commedia (E89). (Alighieri, 1956)

In First Order Logic:

$P130(x,y) \Rightarrow E70(x)$

$P130(x,y) \Rightarrow E70(y)$

$P130(x,y,z) \Rightarrow [P130(x,y) \wedge E55(z)]$

Properties:

P130.1 kind of similarity: E55 Type

P132 spatiotemporally overlaps with

Domain:

E92 Spacetime Volume

Range:

E92 Spacetime Volume

Superproperty of:

E4 Period. P9 consists of (forms part of): E4 Period
E92 Spacetime Volume. P10 falls within (contains): E92 Spacetime Volume

Quantification:

many to many (0,n:0,n)

Scope note:

This symmetric property associates two instances of E92 Spacetime Volume that have some of their extents in common. If only the fuzzy boundaries of the instances of E92 Spacetime Volume overlap, this property cannot be determined from observation alone and therefore should not be applied. However, there may be other forms of justification that the two instances of E92 Spacetime Volume must have some of their extents in common regardless of where and when precisely.

If this property holds for two instances of E92 Spacetime Volume then it cannot be the case that *P133 is spatiotemporally separated* from also holds for the same two instances. Furthermore, there are cases where neither *P132 spatiotemporally overlaps with* nor *P133 is spatiotemporally separated from* holds between two instances of E92 Spacetime Volume. This would occur where only an overlap of the fuzzy boundaries of the two instances of E92 Spacetime Volume occurs and no other evidence is available.

This property is symmetric

Examples:

- The “Urnfield” period (E4) *spatiotemporally overlaps with* the “Hallstatt” period (E4). (Gimbutas, 1965)

In First Order Logic:

$P132(x,y) \Rightarrow E92(x)$

$P132(x,y) \Rightarrow E92(y)$

$P132(x,y) \Rightarrow P132(y,x)$

$P132(x,y) \Rightarrow \neg P133(x,y)$

P133 is spatiotemporally separated from

Domain:

E92 Spacetime Volume

Range:

E92 Spacetime Volume

Quantification:

many to many (0,n:0,n)

Scope note:

This symmetric property associates two instances of E92 Spacetime Volume that have no extents in common. If only the fuzzy boundaries of the instances of E92 Spacetime Volume overlap, this property cannot be determined from observation alone and therefore should not be applied. However, there may be other forms of justification that the two instances of E92 Spacetime Volume must not have any of their extents in common regardless of where and when precisely.

If this property holds for two instances of E92 Spacetime Volume then it cannot be the case that *P132 spatiotemporally overlaps with* also holds for the same two instances. Furthermore, there are cases where neither *P132 spatiotemporally overlaps with* nor *P133 is spatiotemporally separated from* holds between two instances of E92 Spacetime Volume. This would occur where only an overlap of the fuzzy boundaries of the two instances of E92 Spacetime Volume occurs and no other evidence is available.

This property is not transitive. This property is symmetric.

Examples:

- The “Hallstatt” period (E4) *is spatiotemporally separated from* the “La Tène” era (E4). (Marion, 2004)
- Kingdom of Greece (1831-1924) (E92) *is spatiotemporally separated from* Ottoman Empire (1299-1922) (E92).
- The path of the army of Alexander the Great (335-323 B.C.) (E7) *is spatiotemporally separated from* the Mauryan Empire (E4). (Lane Fox, 2004)

In First Order Logic:

$P133(x,y) \Rightarrow E92(x)$
 $P133(x,y) \Rightarrow E92(y)$
 $P133(x,y) \Rightarrow P133(y,x)$
 $P133(x,y) \Rightarrow \neg P132(x,y)$

P134 continued (was continued by)

Domain:

E7 Activity

Range:

E7 Activity

Subproperty of:

E7 Activity. P15 was influenced by (influenced): E1 CRM Entity
E2 Temporal Entity. P176i starts before the start of (starts after the start of): E2 Temporal Entity

Quantification:

many to many (0,n:0,n)

Scope note:

This property associates two instances of E7 Activity, where the domain is considered as an intentional continuation of the range. A continuation of an activity may happen when the continued activity is still ongoing or after the continued activity has completely ended. The continuing activity may have started already before it decided to continue the other one. Continuation implies a coherence of intentions and outcomes of the involved activities.

This property is not transitive.

Examples:

- The construction of the Kölner Dom (Cologne Cathedral) , abandoned in the 15th century (E7), *was continued* by construction in the 19th century (E7). [The construction in the 19th century adapted the initial plans so as to preserve the intended appearance.] (Wolff, 1999)

In First Order Logic:

$P134(x,y) \Rightarrow E7(x)$
 $P134(x,y) \Rightarrow E7(y)$
 $P134(x,y) \Rightarrow P15(x,y)$
 $P134(x,y) \Rightarrow P176i(x,y)$

P135 created type (was created by)

Domain:

E83 Type Creation

Range:

E55 Type

Subproperty of:

E65 Creation. P94 has created (was created by): E28 Conceptual Object

Quantification:

one to many, necessary (1,n:0,1)

Scope note:

This property identifies the instance of E55 Type, which is created in an instance of E83 Type Creation activity.

Examples:

- The description of a new ribbon worm species by Bürger (E83) *created type* ‘*Lineus kennelii*’ (E55). (Bürger, 1892)

In First Order Logic:

$P135(x,y) \Rightarrow E83(x)$
 $P135(x,y) \Rightarrow E55(y)$
 $P135(x,y) \Rightarrow P94(x,y)$

P136 was based on (supported type creation)

Domain:

E83 Type Creation

Range:

E1 CRM Entity

Subproperty of:

E7 Activity. P15 was influenced by (influenced): E1 CRM Entity

Quantification:

many to many (0,n:0,n)

Scope note:

This property identifies one or more instances of E1 CRM Entity that were used as evidence to declare a new instance of E55 Type.

The examination of these items is often the only objective way to understand the precise characteristics of a new type. Such items should be deposited in a museum or similar institution for that reason. The taxonomic role renders the specific relationship of each item to the type, such as "holotype" or "original element".

Examples:

- The taxon creation of the plant species '*Serratula glauca* Linné, 1753.' (E83) was based on Object BM000576251 of the Clayton Herbarium (E20) in the taxonomic role original element (E55). (Blake, 1918)

In First Order Logic:

$P136(x,y) \Rightarrow E83(x)$
 $P136(x,y) \Rightarrow E1(y)$
 $P136(x,y,z) \Rightarrow [P136(x,y) \wedge E55(z)]$
 $P136(x,y) \Rightarrow P15(x,y)$

Properties:

P136.1 in the taxonomic role: E55 Type

P137 exemplifies (is exemplified by)

Domain:

E1 CRM Entity

Range:

E55 Type

Subproperty of:

E1 CRM Entity. P2 has type (is type of): E55 Type

Quantification:

many to many (0,n:0,n)

Scope note:

This property associates an instance of E1 CRM Entity with an instance of E55 Type for which it has been declared to be a particularly characteristic example.

The *P137.1 in the taxonomic role* property of *P137 exemplifies (is exemplified by)* allows differentiation of taxonomic roles. The taxonomic role renders the specific relationship of this example to the type, such as "prototypical", "archetypical", "lectotype", etc. The taxonomic role "lectotype" is not associated with the instance of E83 Type Creation itself but is selected in a later phase.

Examples:

- Object BM000098044 of the Clayton Herbarium (E20) exemplifies '*Spigelia marilandica*' (L.) L. (E55) in the taxonomic role lectotype (E55). (Natural History Museum, 2021)

In First Order Logic:

$P137(x,y) \Rightarrow E1(x)$
 $P137(x,y) \Rightarrow E55(y)$
 $P137(x,y,z) \Rightarrow [P137(x,y) \wedge E55(z)]$
 $P137(x,y) \Rightarrow P2(x,y)$

Properties:

P137.1 in the taxonomic role: E55 Type

P138 represents (has representation)

Domain:

E36 Visual Item

Range:

E1 CRM Entity

Subproperty of:

E89 Propositional Object. P67 refers to (is referred to by): E1 CRM Entity

Quantification:

many to many (0,n:0,n)

Scope note:

This property establishes the relationship between an instance of E36 Visual Item and the instance of E1 CRM Entity that it visually represents.

Any entity may be represented visually. This property is part of the fully developed path from E24 Physical Human-Made Thing through *P65 shows visual item (is shown by)*, E36 Visual Item, *P138 represents (has representation)* to E1 CRM Entity, which is shortcut by *P62 depicts (is depicted by)*. *P138.1 mode of representation* allows the nature of the representation to be refined.

This property is also used for the relationship between an original and a digitisation of the original by the use of techniques such as digital photography, flatbed or infrared scanning. Digitisation is here seen as a process with a mechanical, causal component rendering the spatial distribution of structural and optical properties of the original and does not necessarily include any visual similarity identifiable by human observation.

Examples:

- The digital file found at http://www.emunch.no/N/full/No-MM_N0001-01.jpg (E36) *represents* page 1 of Edward Munch's manuscript MM N 1, Munch-museet (E22) *mode of representation* Digitisation (E55).
- The 3D model VAM_A.200-1946_trace_1M.ply (E73) *represents* Victoria & Albert Museum's Madonna and child sculpture (visual work) A.200-1946 (E22) *mode of representation* 3D surface (E55).

In First Order Logic:

$P138(x,y) \Rightarrow E36(x)$

$P138(x,y) \Rightarrow E1(y)$

$P138(x,y,z) \Rightarrow [P138(x,y) \wedge E55(z)]$

$P138(x,y) \Rightarrow P67(x,y)$

Properties:

P138.1 mode of representation: E55 Type

P139 has alternative form (is alternative form of)

Domain:

E41 Appellation

Range:

E41 Appellation

Quantification:

many to many (0,n:0,n)

Scope note:

This property associates an instance of E41 Appellation with another instance of E41 Appellation that constitutes a derivative or variant of the former and that may also be used for identifying items identified by the former, in suitable contexts, independent from the particular item to be identified. This property should not be confused with additional variants of names used characteristically for a single, particular item, such as individual nicknames. It is a directed relationship, where the range expresses the derivative or variant and the domain the source of derivation or original form of variation, if such a direction can be established. Otherwise, the relationship is symmetric. The relationship is not transitive.

Multiple names assigned to an object, which do not apply to all things identified with the specific instance of E41 Appellation, should be modelled as repeated values of *P1 is identified by (identifies)* of this object.

P139.1 has type allows the type of derivation to be refined, for instance “transliteration from Latin 1 to ASCII”.

Examples:

- “Martin Doerr” (E41) *has alternative form* “Martin Dörr” (E41) *has type* Alternate spelling (E55).
- “Гончарова, Наталья Сергеевна” (E41) *has alternative form* “Gončarova, Natal’â Sergeevna” (E41) *has type* ISO 9:1995 transliteration (E55).
- “Αθήνα” (E41) *has alternative form* “Athina” (E41) *has type* transcription (E55).

In First Order Logic:

$P139(x,y) \Rightarrow E41(x)$

$P139(x,y) \Rightarrow E41(y)$

$P139(x,y,z) \Rightarrow [P139(x,y) \wedge E55(z)]$

Properties:

P139.1 has type: E55 Type

Scope note:

This property associates an instance of E41 Appellation with another instance of E41 Appellation that constitutes a derivative or variant of the former and that may also be used for identifying items identified by the former, in suitable contexts, independent from the particular item to be identified. This property should not be confused with additional variants of names used characteristically for a single, particular item, such as individual nicknames. It is an asymmetric relationship, where the range expresses the derivative, if such a direction can be established. Otherwise, the relationship is symmetric. The relationship is not transitive.

Multiple names assigned to an object, which do not apply to all things identified with the specific instance of E41 Appellation, should be modelled as repeated values of *P1 is identified by (identifies)* of this object.

P139.1 has type allows the type of derivation to be refined, for instance “transliteration from Latin 1 to ASCII”.

Examples:

- “Martin Doerr” (E41) *has alternative form* “Martin Dörr” (E41) *has type* Alternate spelling (E55).
- “Гончарова, Наталья Сергеевна” (E41) *has alternative form* “Gončarova, Natal’â Sergeevna” (E41) *has type* ISO 9:1995 transliteration (E55).
- “Αθήνα” (E41) *has alternative form* “Athina” (E41) *has type* transcription (E55).

In First Order Logic:

$P139(x,y) \Rightarrow E41(x)$
 $P139(x,y) \Rightarrow E41(y)$
 $P139(x,y,z) \Rightarrow \{P139(x,y) \wedge E55(z)\}$
 $P139(x,y) \Rightarrow P139(y,x)$
 $\Rightarrow P139(x,x)$

Properties:

P139.1 has type: E55 Type
P140 assigned attribute to (was attributed by)

Domain:

E13 Attribute Assignment

Range:

E1 CRM Entity

Superproperty of:

E14 Condition Assessment. P34 concerned (was assessed by): E18 Physical Thing
E16 Measurement. P39 measured (was measured by): E18 Physical Thing
E17 Type Assignment. P41 classified (was classified by): E1 CRM Entity

Quantification:

many to many (0,n:0,n)

Scope note:

This property associates an instance of E13 Attribute Assignment with the instance of E1 CRM Entity about which it made an attribution. The instance of E1 CRM Entity plays the role of the domain of the attribution.

The kind of attribution made should be documented using *P177 assigned property type*.

Examples:

- The Current Ownership Assessment of Martin Doerr's silver cup February 1997 (E13) assigned attribute to Martin Doerr's silver cup (E22). (fictitious)
- The Identifier Assignment on 1st June 1997 of the silver cup donated by Martin Doerr (E15) assigned attribute to silver cup 232 (E22). (fictitious)
- The examination of MS Sinai Greek 418 (E13) assigned attribute to MS Sinai Greek 418 (E22). (Honey and Pickwood, 2010)

In First Order Logic:

$P140(x,y) \Rightarrow E13(x)$
 $P140(x,y) \Rightarrow E1(y)$

P141 assigned (was assigned by)

Domain:

E13 Attribute Assignment

Range:

E1 CRM Entity

Superproperty of:

E14 Condition Assessment. P35 has identified (identified by): E3 Condition State
E15 Identifier Assignment. P37 assigned (was assigned by): E42 Identifier
E15 Identifier Assignment. P38 deassigned (was deassigned by): E42 Identifier

E16 Measurement. P40 observed dimension (was observed in): E54 Dimension
E17 Type Assignment. P42 assigned (was assigned by): E55 Type

Quantification:

many to many (0,n:0,n)

Scope note:

This property associates an instance of E13 Attribute Assignment with the instance of E1 CRM Entity used in the attribution. The instance of E1 CRM Entity here plays the role of the range of the attribution.

The kind of attribution made should be documented using *P177 assigned property type*.

Examples:

- The Current Ownership Assessment of Martin Doerr's silver cup February 1997 (E13) *assigned* Martin Doerr (E21). (fictitious)
- The Identifier Assignment on 1st June 1997 of the silver cup donated by Martin Doerr (E15) *assigned* 232 (E42). (fictitious)
- The examination of MS Sinai Greek 418 (E13) *assigned* unsupported (E55). (Honey & Pickwood, 2010)

In First Order Logic:

$P141(x,y) \Rightarrow E13(x)$

$P141(x,y) \Rightarrow E1(y)$

P142 used constituent (was used in)

Domain:

E15 Identifier Assignment

Range:

E90 Symbolic Object

Subproperty of:

E7 Activity. P16 used specific object (was used for): E70 Thing

Quantification:

many to many (0:n:0:n)

Scope note:

This property associates an instance of E15 Identifier Assignment with the instance of E90 Symbolic Object used as constituent of an instance of E42 Identifier in this act of assignment.

Examples:

- Assigning the personal name identifier "Guillaume, de Machaut, ca. 1300-1377" on 1st June, 2001 (E15) *used constituent* "ca. 1300-1377" (E41). (Kelly, 2014)
- Assigning a uniform title to the anonymous textual work known as 'The Adoration of the Shepherds' (E15) *used constituent* "Coventry" (E41). (Encyclopedia Britannica, 1998)
- Assigning a uniform title to Pina Bausch's choreographic work entitled 'Rite of spring' (E15) *used constituent* "(Choreographic Work: Bausch)" (E90). (Brandstetter and Klein, 2015)
- Assigning a uniform title to the motion picture directed in 1933 by Merian C. Cooper and Ernest B. Schoedsack and entitled 'King Kong' (E15) *used constituent* "1933" (E61). (Goldner and Turner, 1976)
- Assigning the corporate name identifier 'Univerza v Ljubljani. Oddelek za bibliotekarstvo' to The Department for library science of the University of Ljubljana in 2018 (E15) *used*

constituent “Univerza v Ljubljani” (E42). [Done by the Department of Library and Information Science and Book Studies Library, University of Ljubljana in 2018]

In First Order Logic:

$P142(x,y) \Rightarrow E15(x)$

$P142(x,y) \Rightarrow E90(y)$

$P142(x,y) \Rightarrow P16(x,y)$

P143 joined (was joined by)

Domain:

E85 Joining

Range:

E39 Actor

Subproperty of:

E5 Event. P11 had participant (participated in): E39 Actor

Quantification:

many to many, necessary (1,n:0,n)

Scope note:

This property identifies the instance of E39 Actor that becomes member of an instance of E74 Group in an instance of E85 Joining.

Joining events allow for describing people-actors becoming members of a group with the more detailed path E74 Group, *P144i gained member by*, E85 Joining, *P143 joined*, E39 Actor, compared to the shortcut offered by *P107 has current or former member (is current or former member of)*.

Examples:

- The election of Sir Isaac Newton as Member of Parliament to the Convention Parliament of 1689 (E85) *joined* Sir Isaac Newton (E21). (Iliffe, 2013)
- The inauguration of Mikhail Sergeevich Gorbachev as leader of the Union of Soviet Socialist Republics (USSR) in 1985 (E85) *joined* Mikhail Sergeevich Gorbachev (E21). (Galeotti, 1997)
- The implementation of the membership treaty 1st January 1973 between EU and Denmark (E85) *joined* Denmark (E74).

In First Order Logic:

$P143(x,y) \Rightarrow E85(x)$

$P143(x,y) \Rightarrow E39(y)$

$P143(x,y) \Rightarrow P11(x,y)$

P144 joined with (gained member by)

Domain:

E85 Joining

Range:

E74 Group

Subproperty of:

E5 Event. P11 had participant (participated in): E39 Actor

Quantification:

many to many, necessary (1,n:0,n)

Scope note:

This property identifies the instance of E74 Group of which an instance of E39 Actor becomes a member through an instance of E85 Joining.

Although a joining activity normally concerns only one instance of E74 Group, it is possible to imagine circumstances under which becoming member of one Group implies becoming member of another Group as well.

Joining events allow for describing people becoming members of a group with a more detailed path from E74 Group through, *P144i gained member by*, E85 Joining, *P143 joined*, E39 Actor, compared to the shortcut offered by *P107 has current or former member (is current or former member of)*.

The property *P144.1 kind of member* can be used to specify the type of membership or the role the member has in the group.

Examples:

- The election of Sir Isaac Newton as Member of Parliament to the Convention Parliament of 1689 (E85) *joined with* the Convention Parliament (E74). (Ilfie, 2013)
- The inauguration of Mikhail Sergeevich Gorbachev as Leader of the Union of Soviet Socialist Republics (USSR) in 1985 (E85) *joined with* the office of Leader of the Union of Soviet Socialist Republics (USSR) (E74) *kind of member* President (E55). (Galeotti, 1997)
- The implementation of the membership treaty 1st January 1973 between EU and Denmark (E85) *joined with* EU (E74).

In First Order Logic:

$P144(x,y) \Rightarrow E85(x)$
 $P144(x,y) \Rightarrow E74(y)$
 $P144(x,y,z) \Rightarrow [P144(x,y) \wedge E55(z)]$
 $P144(x,y) \Rightarrow P11(x,y)$

Properties:

P144.1 *kind of member*: E55 Type

P145 separated (left by)

Domain:

E86 Leaving

Range:

E39 Actor

Subproperty of:

E5 Event. P11 had participant (participated in): E39 Actor

Quantification:

many to many, necessary (1,n:0,n)

Scope note:

This property identifies the instance of E39 Actor that leaves an instance of E74 Group through an instance of E86 Leaving.

Examples:

- The end of Sir Isaac Newton's duty as Member of Parliament for the University of Cambridge to the Convention Parliament in 1702 (E86) *separated* Sir Isaac Newton (E21). (Iliffe, 2013)
- George Washington's leaving office in 1797 (E86) *separated* George Washington (E21). (Unger, 2015)
- The implementation of the treaty regulating the termination of Greenland membership in EU between EU, Denmark and Greenland 1st February 1985 (E86) *separated* Greenland (E74).

In First Order Logic:

$P145(x,y) \Rightarrow E86(x)$

$P145(x,y) \Rightarrow E39(y)$

$P145(x,y) \Rightarrow P11(x,y)$

P146 separated from (lost member by)

Domain:

E86 Leaving

Range:

E74 Group

Subproperty of:

E5 Event. P11 had participant (participated in): E39 Actor

Quantification:

many to many, necessary (1,n:0,n)

Scope note:

This property identifies the instance of E74 Group an instance of E39 Actor leaves through an instance of E86 Leaving.

Although a leaving activity normally concerns only one instance of E74 Group, it is possible to imagine circumstances under which leaving one E74 Group implies leaving another E74 Group as well.

Examples:

- The end of Sir Isaac Newton's duty as Member of Parliament for the University of Cambridge to the Convention Parliament in 1702 (E86) *separated from* the Convention Parliament (E74). (Iliffe, 2013)
- George Washington's leaving office in 1797 (E86) *separated from* the office of President of the United States (E74). (Unger, 2015)
- The implementation of the treaty regulating the termination of Greenland membership in EU between EU, Denmark and Greenland 1st February 1985 (E86) *separated from* EU (E74).

In First Order Logic:

$P146(x,y) \Rightarrow E86(x)$

$P146(x,y) \Rightarrow E74(y)$

$P146(x,y) \Rightarrow P11(x,y)$

P147 curated (was curated by)

Domain:

E87 Curation Activity

Range:

E78 Curated Holding

Quantification:

many to many, necessary (1,n:0,n)

Scope note:

This property associates an instance of E87 Curation Activity with the instance of E78 Curated Holding with that is subject of that curation activity following some implicit or explicit curation plan.

Examples:

- The curation activity of the Benaki Museum for the Toys, Games and Childhood Collection (E87) *curated* The Toys, Games and Childhood Collection of the Benaki Museum (E78). [The curation activity included the acquisition of dolls and games of urban and folk manufacture dating from the 17th to the 20th century, from England, France and Germany for the Toys, Games and Childhood Collection of the museum.] (Benaki Museum, 2016)
- The curation activity for the permanent Numismatic Collection of the Historical Museum of Crete, Heraklion, Crete from 2005 up to the present (E87) *curated* the Numismatic Collection (E78). (Historical Museum of Crete, 2005)
- The curation activity of Mikael Heggelund Foslie (E87) *curated* the Mikael Heggelund Foslie's coralline red algae Herbarium (E78) (Woelkerling et al., 2005)

In First Order Logic:

$P147(x,y) \Rightarrow E87(x)$

$P147(x,y) \Rightarrow E78(y)$

P148 has component (is component of)

Domain:

E89 Propositional Object

Range:

E89 Propositional Object

Quantification:

many to many (0:n,0:n)

Scope note:

This property associates an instance of E89 Propositional Object with a structural part of it that is by itself an instance of E89 Propositional Object.

This property is transitive.

Examples:

- Dante's "Divine Comedy" (E89) *has component* Dante's "Hell" (E89). (Alighieri, 1956)

In First Order Logic:

$P148(x,y) \Rightarrow E89(x)$

$P148(x,y) \Rightarrow E89(y)$

$[P148(x,y) \wedge P148(y,z)] \Rightarrow P148(x,z)$

P150 defines typical parts of (defines typical wholes for)

Domain

E55 Type

Range:

E55 Type

Quantification:

many to many (0,n:0,n)

Scope note:

This property associates an instance of E55 Type “A” with an instance of E55 Type “B”, when items of type “A” typically form part of items of type “B”, such as “car motors” and “cars”.

It allows types to be organised into hierarchies based on one type describing a typical part of another. This property is equivalent to “broader term partitive (BTP)” as defined in ISO 2788 and “broaderPartitive” in SKOS.

This property is not transitive.

Examples:

- car motors (E55) *defines typical parts of* cars (E55). (fictitious)

In First Order Logic:

$P150(x,y) \Rightarrow E55(x)$

$P150(x,y) \Rightarrow E55(y)$

P151 was formed from (participated in)

Domain:

E66 Formation

Range:

E74 Group

Subproperty of:

E5 Event. P11 had participant (participated in): E39 Actor

Quantification:

many to many (0,n:0:n)

Scope note:

This property associates an instance of E66 Formation with an instance of E74 Group from which the new group was formed preserving a sense of continuity such as in mission, membership or tradition.

Examples:

- The formation of the House of Bourbon-Conti in 1581 (E66) *was formed from* House of Condé (E74). (Collectif & Musée d'art et d'histoire Louis-Senlecq, 1900)

In First Order Logic:

$P151(x,y) \Rightarrow E66(x)$

$P151(x,y) \Rightarrow E74(y)$

$P151(x,y) \Rightarrow P11(x,y)$

P152 has parent (is parent of)

Domain:

E21 Person

Range:

E21 Person

Quantification:

many to many, necessary (2,n:0,n)

Scope note:

This property associates an instance of E21 Person with another instance of E21 Person who plays the role of the first instance's parent, regardless of whether the relationship is biological parenthood, assumed or pretended biological parenthood or an equivalent legal status of rights and obligations obtained by a social or legal act.

This property is, among others, a shortcut of the fully developed paths from E21 Person through *P98i was born*, *E67 Birth*, *P96 by mother* to E21 Person, and from E21 Person through *P98i was born*, *E67 Birth*, *P97 from father* to E21 Person.

This property is not transitive.

Examples:

- Gaius Octavius (E21) *has parent* Julius Caesar (E21). (Bleicken & Bell, 2015)
- Steve Jobs (E21) *has parent* Joanne Simpson (E21). [Biological mother] (Isaacson, 2011)
- Steve Jobs (E21) *has parent* Clara Jobs (E21). [Adoption mother] (Isaacson, 2011)

In First Order Logic:

$P152(x,y) \Rightarrow E21(x)$
 $P152(x,y) \Rightarrow E21(y)$
 $P152(x,y) \Leftarrow (\exists z) [E67(z) \wedge P98i(x,z) \wedge P96(z,y)]$
 $P152(x,y) \Leftarrow (\exists z) [E67(z) \wedge P98i(x,z) \wedge P97(z,y)]$

P156 occupies (is occupied by)

Domain:

E18 Physical Thing

Range:

E53 Place

Subproperty of:

E18 Physical Thing. P53 has former or current location (is former or current location of): E53 Place

E18 Physical Thing. P157i provides reference space for : E53 Place

Quantification:

many to one (0,1:0,n)

Scope note:

This property describes the largest volume in space, an instance of E53 Place, that an instance of E18 Physical Thing has occupied at any time during its existence, with respect to the reference space relative to the physical thing itself. This allows for describing the thing itself as a place that may contain other things, such as a box that may contain coins. In other words, it is the volume that contains all the points which the thing has covered at some time during its existence. The reference space for the associated place must be the one that is permanently at rest (*P157 is at rest relative to*) relative to the physical thing. For instances of E19 Physical Objects it is the one which is at rest relative to the object itself, i.e., which moves together with the object. For instances of E26 Physical Feature it is one which is at rest relative to the physical feature itself and the surrounding matter immediately connected to it. Therefore, there is a 1:1 relation between the instance E18 Physical Thing and the instance of E53 Place it occupies. We include in the occupied space the space filled by the matter of the physical thing and all its inner spaces.

This property implies the fully developed path from E18 Physical Thing through *P196 defines*, E92 Spacetime Volume, *P161 has spatial projection* to E53 Place. However, in contrast to *P156 occupies*, the property *P161 has spatial projection* does not constrain the reference space of the referred instance of E53 Place.

In contrast to *P156 occupies*, for the property *P53 has former or current location* the following holds:

It does not constrain the reference space of the referred instance of E53 Place.

It identifies a possibly wider instance of E53 Place at which a thing is or has been for some unspecified time span.

If the reference space of the referred instance of E53 Place is not at rest with respect to the physical thing found there, the physical thing may move away after some time to another place and/or may have been at some other place before. The same holds for the fully developed path from E18 Physical Thing through *P196 defines*, E92 Spacetime Volume, *P161 has spatial projection* to E53 Place.

Examples:

- The Saint Titus reliquary (E22) *occupies* the space of the Saint Titus reliquary (E53). [The reliquary is currently kept in the Saint Titus Church in Heraklion, Crete since 1966 and contains the skull of Saint Titus.] (Fisher & Garvey, 2010)
- Burg Eltz near Koblenz, Germany (E24) *occupies* the space within the 1661AD outer walls of Burg Eltz (E53). [The castle (English name: Eltz Castle) underwent a series of expansions starting in the 12th century until it reached its current extent in 1661AD and contains buildings from various periods.]

In First Order Logic:

$P156(x,y) \Rightarrow E53(y)$

$P156(x,y) \Rightarrow E18(x)$

$P156(x,y) \Leftrightarrow (\exists z) [E18(x) \wedge E53(y) \wedge P196(x,z) \wedge P161(z,y) \wedge P157(y,x)]$

P157 is at rest relative to (provides reference space for)

Domain:

E53 Place

Range:

E18 Physical Thing

Superproperty of:

E53 Place. P59i is located on or within: E18 Physical Thing

E53 Place. P156i is occupied by: E18 Physical Thing

Quantification:

many to many, necessary(1,n:0,n)

Scope note:

This property associates an instance of E53 Place with the instance of E18 Physical Thing that determines a reference space for this instance of E53 Place by being at rest with respect to this reference space. The relative stability of form of an instance of E18 Physical Thing defines its default reference space. The reference space is not spatially limited to the referred thing. For example, a ship determines a reference space in terms of which other ships in its neighbourhood may be described. Larger constellations of matter, such as continental plates, may comprise many physical features that are at rest with them and define the same reference space.

Examples:

- The spatial extent of the municipality of Athens in 2014 (E53) *is at rest relative to* The Royal Observatory in Greenwich (E25). (Maunder, 1900)
- The place where Lord Nelson died on H.M.S. Victory (E53) *is at rest relative to* H.M.S. Victory (E22). (Adkin, 2005)

In First Order Logic:

$P157(x,y) \Rightarrow E53(x)$

$P157(x,y) \Rightarrow E18(y)$

P160 has temporal projection (is temporal projection of)

Domain:

[E92](#) Spacetime Volume

Range:

[E52](#) Time-Span

Superproperty of:

[E93](#) Presence. [P164](#) is temporally specified by (temporally specifies): [E52](#) Time-Span

Quantification:

many to one, necessary (1,1:0,n)

Scope note:

This property describes the temporal projection of an instance of [E92](#) Spacetime Volume. The property *P4 has time-span* is the same as *P160 has temporal projection* if it is used to document an instance of [E4](#) Period or any subclass of it.

Example:

- The spatio-temporal trajectory of the H.M.S. Temeraire from its building in 1798 to its destruction in 1838 ([E92](#)) *has temporal projection* The Time-Span of the existence of H.M.S. Temeraire ([E52](#)) [*at some time within* ([P82](#)) “1798-1838” ([E61](#)).] (Willis, 2010)
- The Battle of Waterloo 1815 ([E7](#)) *has temporal projection* the time-span of The Battle of Waterloo ([E52](#)) [*at some time within* ([P82](#)) “Sunday, 18th June 1815” ([E61](#)).] (Black, 2010)

In First Order Logic:

$P160(x,y) \Rightarrow E92(x)$

$P160(x,y) \Rightarrow E52(y)$

P161 has spatial projection (is spatial projection of)

Domain:

[E92](#) Spacetime Volume

Range:

[E53](#) Place

Subproperty of:

[E4](#) Period. [P7](#) took place at (witnessed): [E53](#) Place

Quantification:

one to many, necessary, dependent (1,n:0,n)

Scope note:

This property associates an instance of an instance of [E92](#) Spacetime Volume with an instance of [E53](#) Place that is the result of the spatial projection of the instance of the [E92](#) Spacetime Volume on a reference space.

In general, there can be more than one useful reference space (for reference space see *P156 occupies* and *P157 is at rest relative to*) to describe the spatial projection of a spacetime volume, for example, in describing a sea battle, the difference between the battle ship and the seafloor as reference spaces. Thus, it can be seen that the projection is not unique.

The spatial projection is the actual spatial coverage of a spacetime volume, which normally has fuzzy boundaries except for instances of [E92](#) Spacetime Volumes which are geometrically

defined in the same reference system as the range of this property are an exception to this and do not have fuzzy boundaries. Modelling explicitly fuzzy spatial projections serves therefore as a common topological reference of different spatial approximations rather than absolute geometric determination, for instance for relating outer or inner spatial boundaries for the respective spacetime volumes.

In case the domain of an instance of *P161 has spatial projection* is an instance of E4 Period, the spatial projection describes all areas that period was ever present at, for instance, the Roman Empire.

This property is part of the fully developed path from E18 Physical Thing through *P196 defines*, E92 Spacetime Volume, *P161 has spatial projection* to E53 Place, which in turn is implied by *P156 occupies (is occupied by)*.

This property is part of the fully developed path from E4 Period through *P161 has spatial projection*, E53 Place, *P89 falls within (contains)* to E53 Place, which in turn is shortcut by *P7 took place at (witnessed)*.

Example:

- The Roman Empire (E4) *has spatial projection* all areas ever claimed by Rome (E53). (Clare & Edwards, 1992)

In First Order Logic:

$P161(x,y) \Rightarrow E92(x)$

$P161(x,y) \Rightarrow E53(y)$

P164 is temporally specified by (temporally specifies)

Domain:

E93 Presence

Range:

E52 Time-Span

Subproperty of:

E92 Spacetime Volume. P160 has temporal projection (is temporal projection of): E52 Time-Span

Quantification:

many to one, necessary(1,1:0,n)

Scope note:

This property relates an instance of E93 Presence with the instance of E52 Time-Span that defines the time-slice of the spacetime volume that this instance of E93 Presence is related to via the property *P166 was a presence of (had presence)*.

There are two typical cases for the determination of the related instance of E52 Time-Span. In the first, it is the temporal extent of an instance of E2 Temporal Entity (documented with *P4 has time-span (is time-span of)*): this then documents the simultaneity of the instance of E93 Presence and the instance of E2 Temporal Entity, even if the absolute time-span is not known, and can be regarded as a phenomenal timespan. In the second, the instance of E52 Time-Span is a date range declared in or derived from historical sources or provided by dating methods: this is a declarative timespan.

Examples:

- 2016-02-09 (E52) *temporally specifies* the last day of the 2016 Carnival in Cologne (E93).
- Johann Joachim Winckelmann's whereabouts in December 1755 (E93) *is temporally specified by* December 1755 (E52.) (Leppmann, 1970)
- Johann Joachim Winckelmann's whereabouts from 19th November 1755 until 9th April 1768 (E93) *is temporally specified by* November 19th 1755 until 9th April 1768 (E52). (Leppmann, 1970)

In First Order Logic:

$P164(x,y) \Rightarrow E93(x)$

$P164(x,y) \Rightarrow E52(y)$

$P164(x,y) \Rightarrow P160(x,y)$

P165 incorporates (is incorporated in)

Domain:

E73 Information Object

Range:

E90 Symbolic Object

Subproperty of:

E90 Symbolic Object. P106 is composed of (forms part of): E90 Symbolic Object

Quantification:

many to many (0,n:0,n)

Scope note:

This property associates an instance of E73 Information Object with an instance of E90 Symbolic Object (or any of its subclasses) that was included in it.

This property makes it possible to recognise the autonomous status of the incorporated signs, which were created in a distinct context, and can be incorporated in many instances of E73 Information Object, and to highlight the difference between structural and accidental whole-part relationships between conceptual entities.

It accounts for many cultural facts that are quite frequent and significant: the inclusion of a poem in an anthology, the re-use of an operatic aria in a new opera, the use of a reproduction of a painting for a book cover or a CD booklet, the integration of textual quotations, the presence of lyrics in a song that sets those lyrics to music, the presence of the text of a play in a movie based on that play, etc.

In particular, this property allows for modelling relationships of different levels of symbolic specificity, such as the natural language words making up a particular text, the characters making up the words and punctuation, the choice of fonts and page layout for the characters.

When restricted to information objects, that is, seen as a property with E73 Information Object as domain and range the property is transitive.

A digital photograph of a manuscript page incorporates the text of a manuscript page, if the respective text is defined as a sequence of symbols of a particular type, such as Latin characters, and the resolution and quality of the digital image is sufficient to resolve these symbols so they are readable on the digital image.

Examples:

- The content of Charles-Moise Briquet's 'Les Filigranes: dictionnaire historique des marques du papier' (E32) *incorporates* the visual aspect of the watermark used around 1358-61 by some Spanish papermaker(s) and identified as 'Briquet 4019' (E37). (Briquet, 1985)
- The visual content of Jacopo Amigoni's painting known as 'The Singer Farinelli and friends' (E36) *incorporates* the musical notation of Farinelli's musical work entitled 'La Partenza' (E73). (National Gallery of Victoria)
- The visual content of Nicolas Poussin's painting entitled 'Les Bergers d'Arcadie' (E36) *incorporates* the Latin phrase 'Et in Arcadia ego' (E33). (Wikipedia, 2020)

In First Order Logic:

$P165(x,y) \Rightarrow E73(x)$

$P165(x,y) \Rightarrow E90(y)$

$P165(x,y) \Rightarrow P106(x,y)$

P166 was a presence of (had presence)

Domain:

E93 Presence

Range:

E92 Spacetime Volume

Subproperty of:

E92 Spacetime Volume. P10 falls within (contains): E92 Spacetime Volume

Quantification:

many to one, necessary (1,1:0,n)

Scope note:

This property associates an instance of E93 Presence with the instance of E92 Spacetime Volume of which it represents a temporal restriction (i.e.: a time-slice). Instantiating this property constitutes a necessary part of the identity of the respective instance of E93 Presence.

Examples:

- The Roman Empire on 19 August AD 14 (E93) *was a presence of* The Roman Empire (E4). (Clare and Edwards, 1992)

In First Order Logic:

$P166(x,y) \Rightarrow E93(x)$,

$P166(x,y) \Rightarrow E92(y)$,

$P166(x,y) \Rightarrow P10(x,y)$

P167 was within (includes)

Domain:

E93 Presence

Range:

E53 Place

Quantification:

many to many, necessary (1,n:0,n)

Scope note:

This property associates an instance of E93 Presence with an instance of E53 Place that geometrically includes the spatial projection of the respective instance of E93 Presence.

Besides others, this property may be used to state in which space an object has been for some known time, such as a room of a castle or in a drawer. It may also be used to describe a confinement of the spatial extent of some realm during a known time-span.

This property is a shortcut of the more fully developed path from E93 Presence through *P161 has spatial projection*, E53 Place, *P89 falls within (contains)* to E53 Place.

Examples:

- Johann Joachim Winkelmann's whereabouts in December 1755 (E93) *was within* Rome (E53). (Leppmann, 1970)
- Johann Joachim Winkelmann's whereabouts from 19th November 19 1755 until 9th April 1768 (E93) *was within* Italy (E53). (Leppmann, 1970)

In First Order Logic:

$P167(x,y) \Rightarrow E93(x)$

$P167(x,y) \Rightarrow E53(y)$

$P167(x,y) \Leftrightarrow (\exists z) [E53(z) \wedge P161(x,z) \wedge P89(z,y)]$

P168 place is defined by (defines place)

Domain:

E53 Place

Range:

E94 Space Primitive

Subproperty of:

E1 CRM Entity. P1 is identified by: E41 Appellation

Quantification:

one to many, dependent (0,n:1,1)

Scope note:

This property associates an instance of E53 Place with an instance of E94 Space Primitive that defines it. Syntactic variants or use of different scripts may result in multiple instances of E94 Space Primitive defining exactly the same place. Transformations between different reference systems always result in new definitions of places approximating each other and not in alternative definitions.

Examples:

- The centroid from <https://sws.geonames.org/735927> (E53) place *is defined by* 40°31'17.9"N 21°15'48.3"E (E94). [A single point for approximating the centre of the city of Kastoria, Greece]
- Martin's coordinates for Kastoria (E53) place *is defined by* 40°30'23"N 21°14'53"E, 40°31'40"N 21°16'43"E (E94). [A square covering the built settlement structure of Kastoria, Greece]
- Martin's centroid for Kastoria (E53) place *is defined by* 40°31'01.5"N 21°15'48"E (E94). [A point in the lake of Kastoria in the centre of the area covered by the city]
- The position measured by Alexander von Humboldt for the Plaza Mayor in Cumaná, Sucre, Venezuela 1799-1800AD (E53) *place is defined by* 10°27'52"N 66°30'02"W (E94). [West of the Observatory of Paris = 64°09'51"W of Greenwich, actually 1,1km east of today's Plaza Andrés Bello Blanco of Cumaná] (Humboldt, 1859)

In First Order Logic:

$P168(x,y) \Rightarrow E53(x)$

$P168(x,y) \Rightarrow E94(y)$

P169 defines spacetime volume (spacetime volume is defined by)

Domain:

E95 Spacetime Primitive

Range:

E92 Spacetime Volume

Subproperty of:

E41 Appellation. P1i identifies: E1 CRM Entity

Quantification:

many to one, necessary (1,1:0,n)

Scope note:

This property associates an instance of E95 Spacetime Primitive with the instance of E92 Spacetime Volume it defines.

Examples:

- {40°30'23"N 21°14'53"E, 40°31'40"N 21°16'43"E, 200BC-2020AD} (E95) *defines spacetime volume* Martin's spatiotemporal enclosure 2020 for the evolution of the settlement of today's city of Kastoria, Greece, since its conquest by the Romans (E92). [A square covering the current built settlement structure of Kastoria, Greece, through the years 200BC to 2020AD, which includes the extents of earlier phases of the city]

In First Order Logic:

$P169(x,y) \Rightarrow E95(x)$

$P169(x,y) \Rightarrow E92(y)$

$P169(x,y) \Rightarrow P1i(x,y)$

P170 defines time (time is defined by)

Domain:

E61 Time Primitive

Range:

E52 Time-Span

Subproperty of:

E41 Appellation. P1i identifies: E1 CRM Entity

Quantification:

many to one (0,1:0,n)

Scope note:

This property associates an instance of E61 Time Primitive with the instance of E52 Time-Span that constitutes the interpretation of the terms of the time primitive as an extent in absolute, real time.

The quantification allows several instances of E61 Time Primitive that are each expressed in different syntactic forms, to define the same instance of E52 Time-Span.

Examples:

- "1800/1/1 0:00:00 – 1899/31/12 23:59:59" (E61) *defines time* the 19th century (E52).
- "1968/1/1 – 2018/1/1" (E61) *defines time* 1968/1/1 – 2018/1/1 (E52). [an arbitrary time-span during which the Saint Titus reliquary was present in the Saint Titus Church in Heraklion, Crete]

In First Order Logic:

$P170(x,y) \Rightarrow E61(x)$
 $P170(x,y) \Rightarrow E52(y)$
 $P170(x,y) \Rightarrow P81i(x,y) \wedge P82i(x,y)$

P171 at some place within

Domain:

E53 Place

Range:

E94 Space Primitive

Quantification

many to many (0,n:0,n)

Scope note:

This property describes the maximum spatial extent within which an instance of E53 Place falls. Since instances of E53 Places may not have precisely known spatial extents, the CIDOC CRM supports statements about maximum spatial extents of instances of E53 Place. This property allows an instance of E53 Place's maximum spatial extent (i.e., its outer boundary) to be assigned an instance of E94 Space Primitive value.

This property is a shortcut of the fully developed path from E53 Place, *P89 falls within*, E53 Place, *P168 place is defined by* to E94 Space Primitive through a declarative Place that is not explicitly documented, to a Space Primitive: declarative places are defined in CRMgeo (Doerr and Hiebel 2013).

Examples:

- The spatial extent of the Acropolis of Athens (E53) *at some place within* POLYGON ((37.969172 23.720787, 37.973122 23.721495 37.972741 23.728994, 37.969299 23.729735, 37.969172 23.720787)) (E94).

In First Order Logic:

$P171(x,y) \Rightarrow E53(x)$
 $P171(x,y) \Rightarrow E94(y)$
 $P171(x,y) \Leftrightarrow (\exists z) [E53(z) \wedge P89(x,z) \wedge P168(z,y)]$

P172 contains

Domain:

E53 Place

Range:

E94 Space Primitive

Quantification:

many to many (0,n:0,n)

Scope note:

This property describes a minimum spatial extent which is contained within an instance of E53 Place. Since instances of E53 Place may not have precisely known spatial extents, the CIDOC CRM supports statements about minimum spatial extents of instances of E53 Place. This property allows an instance of E53 Places's minimum spatial extent (i.e., its inner boundary or a point being within a Place) to be assigned an instance of E94 Space Primitive value.

This property is a shortcut of the fully developed path from E53 Place, *P89i contains*, E53 Place, *P168 place is defined by* to E94 Space Primitive

Examples:

- The spatial extent of the Acropolis of Athens (E53) *contains* POINT (37.971431 23.725947) (E94).

In First Order Logic:

$P172(x,y) \Rightarrow E53(x)$
 $P172(x,y) \Rightarrow E94(y)$
 $P172(x,y) \Leftrightarrow (\exists z) [E53(z) \wedge P89i(x,z) \wedge P168(z,y)]$

P173 starts before or with the end of (ends after or with the start of)

Domain:

E2 Temporal Entity

Range:

E2 Temporal Entity

Superproperty of:

E2 Temporal Entity. P174 starts before the end of (ends after the start of): E2 Temporal Entity

Quantification:

many to many (0,n:0,n)

Scope note:

This property specifies that the temporal extent of the domain instance A of E2 Temporal Entity starts before or simultaneously with the end of the temporal extent of the range instance B of E2 Temporal Entity.

In other words, if $A = [A^{start}, A^{end}]$ and $B = [B^{start}, B^{end}]$, we mean $A^{start} \leq B^{end}$ is true.

This property is part of the set of temporal primitives P173 – P176, P182 – P185.

This property corresponds to the disjunction (logical OR) of the following Allen temporal relations (Allen, 1983): {before, meets, met-by, overlaps, starts, started-by, contains, finishes, finished-by, equals, during, overlapped by}.



Figure 8: Temporal entity A starts before or with the end of temporal entity B. Here A is longer than B

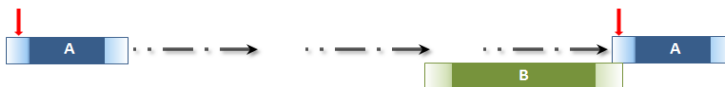

Figure 9: Temporal entity A starts before or with the end of temporal entity B. Here A is shorter than B

Examples:

- The legendary run from Marathon to Athens 490BC (E7) *starts before or with the end of* The Battle of Marathon 490BC (E7).
- LMIIB (E4) *P173i ends after or with the start of* the Tutankhamun period (1332-1323 B.C.E.) (E4). [Evidence for this is provided by the scarab seal found at Poros in a context of LMIIB. The scarab belongs to the type “nh.s n Jmn”. During the Akhenaten period he production of these scarab seals stopped (the name of Amun is not referred to during his reign). So the scarab could not have been produced before the Tutankhamun period and is probably a later production.] (Karetsou, 2000)

In First Order Logic:

$P173(x,y) \Rightarrow E2(x)$

$P173(x,y) \Rightarrow E2(y)$

P174 starts before the end of (ends after the start of)

Domain:

E2 Temporal Entity

Range:

E2 Temporal Entity

Subproperty of:

E2 Temporal Entity. P173 starts before or at-with the end of (ends after or with the start of): E4 Temporal Entity

Superproperty of:

E2 Temporal Entity. P175 starts before or with the start of (starts after or with the start of): E2 Temporal Entity

E2 Temporal Entity. P184 ends before or with the end of (ends with or after the end of): E2 Temporal Entity

Quantification:

many to many (0,n:0,n)

Scope note:

This property specifies that the temporal extent of the domain instance A of E2 Temporal Entity starts definitely before the end of the temporal extent of the range instance B of E2 Temporal Entity.

In other words, if $A = [A^{start}, A^{end}]$ and $B = [B^{start}, B^{end}]$, we mean $A^{start} < B^{end}$ is true.

This property is part of the set of temporal primitives P173 – P176, P182 – P185.

This property corresponds to a disjunction (logical OR) of the following Allen temporal relations (Allen, 1983): {before, meets, overlaps, starts, started-by, contains, finishes, finished-by, equals, during, overlapped by}

Typically, this property is a consequence of a known influence of some event on another event or activity, such as a novel written by someone being continued by someone else, or the knowledge of a defeat on a distant battlefield causing people to end their ongoing activities. This property is not transitive.



Figure 10: Temporal entity A starts before the end of temporal entity B. Here A is longer than B



Figure 11: Temporal entity A starts before the end of temporal entity B. Here A is shorter than B

Examples:

- The settling activity of the city of Assur (Ashur) (E7) starts before the end of The Tenth Dynasty of Egypt (E4). [There are some 200 - 300 years differences in the chronology of the First Intermediate Period, and Assur is dated to "about 2500 BC".] (Pedersén, 1986)
- The building of the current St. Peters in Rome (E7) starts before the end of the demolition of the old 4th c. St. Peters (E6, E7)

Formatted: List Paragraph, Tab stops: 0", List tab

In First Order Logic:

- $P174(x,y) \Rightarrow E2(x)$
- $P174(x,y) \Rightarrow E2(y)$
- $P174(x,y) \Rightarrow P173(x,y)$

P175 starts before or with the start of (starts after or with the start of)

Domain:

$E2$ Temporal Entity

Range:

$E2$ Temporal Entity

Subproperty of:

$E2$ Temporal Entity. $P174$ starts before the end of (ends after the start of): $E2$ Temporal Entity

Superproperty of:

$E2$ Temporal Entity. $P176$ starts before the start of (starts after the start of): $E2$ Temporal Entity

Quantification:

many to many (0,n:0,n)

Scope note:

This property specifies that the temporal extent of the domain instance A of E2 Temporal Entity starts before or simultaneously with the start of the temporal extent of the range instance B of E2 Temporal Entity.

In other words, if $A = [A^{\text{start}}, A^{\text{end}}]$ and $B = [B^{\text{start}}, B^{\text{end}}]$, we mean $A^{\text{start}} \leq B^{\text{start}}$ is true.

This property is part of the set of temporal primitives P173 – P176, P182 – P185.

This property corresponds to a disjunction (logical OR) of the following Allen temporal relations (Allen, 1983): {before, meets, overlaps, starts, started-by, contains, finished-by, equals}

In a model with fuzzy borders, this property will not be transitive.



Figure 12: Temporal entity A starts before or with the start of temporal entity B. Here A is longer than B



Figure 13: Temporal entity A starts before or with the start of temporal entity B. Here A is shorter than B

Examples:

- The production of the scarab seal found in Poros in a context of LMIIIB (E12) *starts after or with the start of* Tutankhamun period (1332-1323 B.C) (E4). [The scarab stamp seal found in Poros was associated with finds dated to the LMIIIB period. The seal is dated to the Tutankhamun period or later because it belongs to the scarabs of type “nh.s n Jmn”: During Akhenaten period, the production of this type of scarab seal stopped (the name of Amun is not referred to during his reign). Therefore, the scarab cannot have been produced before the Tutankhamun period and is probably a later production] (Karetsou, 2000)
- The production of the cylindrical seal of the first Dynasty of Babylon found in Tholos B in Platanos (E12) *starts after or with the start of* the Hammurabi period of the kingdom (E4). [Of the cylindrical seal of the first Dynasty of Babylon found in tholos B in Platanos believed to connect king Hammurabi with the MM I period. Specifically, although the finding is believed to have been found in a MM I layer, it contained material from the MM III/YM I period. Therefore, the seal may be from the Hammurabi period or, it may be from a later period.] (Walberg, 1992.)

In First Order Logic:

- $P175(x,y) \Rightarrow E2(x)$
- $P175(x,y) \Rightarrow E2(y)$
- $P175(x,y) \Rightarrow P174(x,y)$

P176 starts before the start of (starts after the start of)

Domain:

E2 Temporal Entity

Range:

E2 Temporal Entity

Subproperty of:

E2 Temporal Entity. P175 starts before or with the start of (starts after or with the start of): E2 Temporal Entity

Superproperty of:

E7 Activity. P134j was continued by: E7 Activity
E2 Temporal Entity. P182 ends before or **at-with** the start of (starts after or with the end of): E4 Temporal Entity

Quantification:

many to many (0,n:0,n)

Scope note:

This property specifies that the temporal extent of the domain instance A of E2 Temporal Entity starts definitely before the start of the temporal extent of the range instance B of E2 Temporal Entity.

In other words, if $A = [A^{start}, A^{end}]$ and $B = [B^{start}, B^{end}]$, we mean $A^{start} < B^{start}$ is true.

This property is part of the set of temporal primitives P173 – P176, P182 – P185.

This property corresponds to a disjunction (logical OR) of the following Allen temporal relations (Allen, 1983): {before, meets, overlaps, contains, finished-by}. This property is transitive.



Figure 14: Temporal entity A starts before the start of temporal entity B. Here A is longer than B

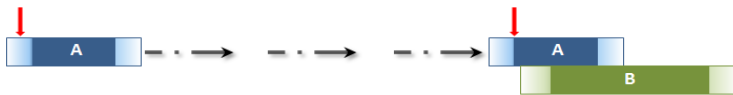

Figure 15: Temporal entity A starts before the start of temporal entity B. Here A is shorter than B

In First Order Logic:

$P176(x,y) \Rightarrow E2(x)$
 $P176(x,y) \Rightarrow E2(y)$
 $P176(x,y) \Rightarrow P175(x,y)$
 $[P176(x,y) \wedge P176(y,z)] \Rightarrow P176(x,z)$

P177 assigned property of type (is type of property assigned)

Domain:

[E13](#) Attribute Assignment

Range:

[E55](#) Type

Subproperty of:

[E1](#) CRM Entity. [P2](#) has type (is type of): [E55](#) Type

Quantification:

many to many, necessary (1,n:0,n)

Scope note:

This property associates an instance of E13 Attribute Assignment with the type of property or relation that this assignment maintains to hold between the item to which it assigns an attribute and the attribute itself. Note that the properties defined by the CIDOC CRM also constitute instances of E55 Type themselves. The direction of the assigned property *of* type is understood to be from the attributed item (the range of property *P140 assigned attribute to*) to the attribute item (the range of the property *P141 assigned*). More than one property type may be assigned to hold between two items.

A comprehensive explanation about refining CIDOC CRM concepts by E55 Type is given in the section “About Types” in the section on “Specific Modelling Constructs” of this document.

Examples

- The Current Ownership Assessment of Martin Doerr’s silver cup February 1997 (E13) *assigned property of type* P52 has former or current owner (is former or current keeper of) (E55). (fictitious)
- 01 June 1997 Identifier Assignment of the silver cup donated by Martin Doerr (E15) *assigned property of type* P48 has preferred identifier (is preferred identifier of) (E55). (fictitious)
- The examination of MS Sinai Greek 418 (E13) *assigned property of type* binding structure type (E55). [‘binding structure type’ refers to a property, external to the CIDOC CRM, which connects a book (E22) to the type of its binding structure (E55)] (Honey & Pickwoad, 2010)
- The condition assessment of the endband cores of MS Sinai Greek 418 (E14) *assigned property of type* damage (E55.) [‘damage’ refers to a property, external to the CIDOC CRM which connects an instance of a physical thing like an endband core (E22) to the type of damage (E55) it shows] (Honey & Pickwoad, 2010)
- The condition assessment of the cover of MS Sinai Greek 418 (E14) *assigned property of type* quality (E55). [‘quality’ refers to a property, external to the CIDOC CRM, which connects an instance of a physical thing like a book cover (E22) to its quality (E55)] (Honey and Pickwoad, 2010)

In First Order Logic:

$P177(x,y) \Rightarrow E13(x)$

$P177(x,y) \Rightarrow E55(y)$

P179 had sales price (was sales price of)

Domain:

E96 Purchase

Range:

E97 Monetary Amount

Quantification:

many to many (1,n; 0,n)

Scope note:

This property establishes the relationship between an instance of E96 Purchase and the instance of E97 Monetary Amount that forms the compensation for the transaction. The monetary amount agreed upon may change in the course of the purchase activity.

Examples:

- The sale of Vincent van Gogh’s “Still Life: Vase with Fifteen Sunflowers” 30th March 1987 (E96) *had sales price* Christies’ hammer price for “Still Life: Vase with Fifteen Sunflowers” (E97).
- The purchase of 10 okka of nails by the captain A. Syrmas on 18th September 1895 (E96) *had sales price* 20 piastre (grosi) (E97). (Syrmas, 1896)

In First Order Logic:

$P179(x,y) \Rightarrow E96(x)$

$P179(x,y) \Rightarrow E97(y)$

P180 has currency (was currency of)

Domain:

[E97](#) Monetary Amount

Range:

[E98](#) Currency

Subproperty of:

[E54](#) Dimension, [P91](#) has unit (is unit of): [E58](#) Measurement Unit

Quantification:

many to one, necessary (1,1; 0,n)

Scope note:

This property establishes the relationship between an instance of [E97](#) Monetary Amount and the instance of [E98](#) Currency that it is measured in.

Examples:

- Christie's hammer price for Vincent van Gogh's "Still Life: Vase with Fifteen Sunflowers" in London on 30th March 1987 ([E97](#)) *has currency* British Pounds ([E98](#)).

In First Order Logic:

$P180(x,y) \Rightarrow E97(x)$

$P180(x,y) \Rightarrow E98(y)$

$P180(x,y) \Rightarrow P91(x,y)$

P182 ends before or with the start of (starts after or with the end of)

Domain:

[E2](#) Temporal Entity

Range:

[E2](#) Temporal Entity

Subproperty of:

[E2](#) Temporal Entity, [P176](#) starts before the start of (starts after the start of): [E2](#) Temporal Entity

[E2](#) Temporal Entity, [P185](#) ends before the end of (ends after the end of): [E2](#) Temporal Entity

Superproperty of:

[E2](#) Temporal Entity, [P183](#) ends before the start of (starts after the end of): [E2](#) Temporal Entity

Quantification:

many to many (0,n:0,n)

Scope note:

This property specifies that the temporal extent of the domain instance A of [E2](#) Temporal Entity ends before or simultaneously with the start of the temporal extent of the range instance B of [E2](#) Temporal Entity.

In other words, if $A = [A^{start}, A^{end}]$ and $B = [B^{start}, B^{end}]$, we mean $A^{end} \leq B^{start}$ is true.

This property is part of the set of temporal primitives [P173](#) – [P176](#), [P182](#) – [P185](#).

This property corresponds to a disjunction (logical OR) of the following Allen temporal relations (Allen, 1983): {before, meets}.



Figure 16: Temporal entity A ends before or with the start of temporal entity B. Here A is longer than B



Figure 17: Temporal entity A ends before or with the start of temporal entity B. Here A is shorter than B

Examples:

- Lerna III (E4) ends before or with the start of Lerna IV (E4). [“The site at Lerna probably was not left uninhabited for long after the destruction of the House of the Tiles and the raising of the tumulus. If there was a gap corresponding to the earliest stage of EH III in the Argolid, as has been suggested by some (see, e.g., Manning 1995: 55–60), it was a brief one. In Rutter’s view, the short life of the Fourth Settlement began ca. 2200/2150 b.c. and ended ca. 2050/2000 b.c.”] (Banks & Reese, 2013)
- The use of LH I graves of Krisa in Phocis (E4) ends before or with the start of LH III phase of reuse of the graves of Krisa in Phocis (E4). [“...a possible hiatus in the occupation of certain sites such as the settlement of Krisa in Phocis, which was well occupied in the MH and LHIII periods. LHIIB pottery from this settlement has already been identified, but no certain example of LHIIA pottery.”] (Phialon 2018)

In First Order Logic:

- $P182(x,y) \Rightarrow E2(x)$
- $P182(x,y) \Rightarrow E2(y)$
- $P182(x,y) \Rightarrow P176(x,y)$
- $P182(x,y) \Rightarrow P185(x,y)$

P183 ends before the start of (starts after the end of)

Domain:

E2 Temporal Entity

Range:

E2 Temporal Entity

Subproperty of:

E2 Temporal Entity, P182 ends before or with the start of (starts after or with the end of): E2 Temporal Entity

Quantification:

many to many (0,n:0,n)

Scope note:

This property specifies that the temporal extent of the domain instance A of E2 Temporal Entity ends definitely before the start of the temporal extent of the range instance B of E2 Temporal Entity.

In other words, if $A = [A^{start}, A^{end}]$ and $B = [B^{start}, B^{end}]$, we mean $A^{end} < B^{start}$ is true.

This property is part of the set of temporal primitives P173 – P176, P182 – P185.

This property corresponds to the following Allen temporal relation (Allen, 1983) : {before}.

This property is transitive.

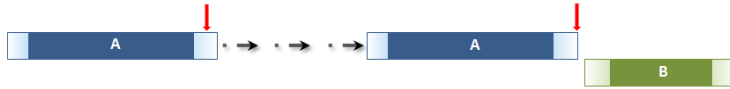

Figure 18: Temporal entity A ends before the start of temporal entity B. Here A is longer than B



Figure 19: Temporal entity A ends before the start of temporal entity B. Here A is shorter than B

Examples:

- Gisle taking office as Bishop of Linköping 1139 AD (E7) ends before the start of The Guta saga composition (E65). (Peel, 1999)
- Troy VII (E4) ends before the start of Troy VIII (E4). [uninhabited for some 200 years]
- The use of the Tomb Four from Nikitopoulou group in Nihoria in the MHIII-LHI period (E4) ends before the start of the period of reuse of the Tomb Four from Nikitopoulou group in LHIIIA (E4). [“Of the six tombs excavated in the Nikitopoulou group [...] the finds in Tomb Four are of MH II or MH III-LH I date, with the exception of the finds with the Northern group of material, which is uniformly dated to LHIIA2, end the ewer in the middle of the floor, dated LHIIIA1. [...] The preserved evidence seems clearly to indicate use in the MHIII-LHI use in the MHIII-LHI period followed by a period of reuse in LHIIIA, a pattern matched at architecturally similar sites such as 13:Kaminia and 10:Gouvaláři”] (Boyd, 2002)

In First Order Logic:

- $P183(x,y) \Rightarrow E2(x)$
- $P183(x,y) \Rightarrow E2(y)$
- $P183(x,y) \Rightarrow P182(x,y)$
- $[P183(x,y) \wedge P183(y,z)] \Rightarrow P183(x,z)$

P184 ends before or with the end of (ends with or after the end of)

Domain:

E2 Temporal Entity

Range:

E2 Temporal Entity

Subproperty of:

E2 Temporal Entity. P174 starts before the end of (ends after the start of): E2 Temporal Entity

Superproperty of:

E2 Temporal Entity. P185 ends before the end of (ends after the end of): E2 Temporal Entity

Quantification:

many to many (0,n:0,n)

Scope note:

This property specifies that the temporal extent of the domain instance A of E2 Temporal Entity ends before or simultaneously with the end of the temporal extent of the range instance B of E2 Temporal Entity.

In other words, if $A = [A^{start}, A^{end}]$ and $B = [B^{start}, B^{end}]$, we mean $A^{end} \leq B^{end}$ is true.

This property is part of the set of temporal primitives P173 – P176, P182 – P185.

This property corresponds to a disjunction (logical OR) of the following Allen temporal relations (Allen, 1983): {before, meets, overlaps, finished by, start, equals, during, finishes}.



Figure 20: Temporal entity A ends before or with the end of temporal entity B. Here A is longer than B



Figure 21: Temporal entity A ends before or with the end of temporal entity B. Here A is shorter than B

Examples:

- The reign/life of Harold II (E4) ends before or with the end of the Battle of Hastings (E7)

In First Order Logic:

$P184(x,y) \Rightarrow E2(x)$

$P184(x,y) \Rightarrow E2(y)$

$P184(x,y) \Rightarrow P174(x,y)$

P185 ends before the end of (ends after the end of)

Domain:

E2 Temporal Entity

Range:

E2 Temporal Entity

Subproperty of:

E2 Temporal Entity. P184 ends before or with the end of (ends with or after the end of): E2 Temporal Entity

Superproperty of:

E2 Temporal Entity. P182 ends before or at-with the start of (starts after or with the end of): E2 Temporal Entity

Quantification:

many to many (0,n:0,n)

Scope note:

This property specifies that the temporal extent of the domain instance A of E2 Temporal Entity ends definitely before the end of the temporal extent of the range instance B of E2 Temporal Entity.

In other words, if $A = [A^{start}, A^{end}]$ and $B = [B^{start}, B^{end}]$, we mean $A^{end} < B^{end}$ is true.

This property is part of the set of temporal primitives P173 – P176, P182 – P185.

Formatted: CRM Example, Outline numbered + Level: 1 + Numbering Style: Bullet + Aligned at: 1" + Tab after: 0" + Indent at: 1.14"

This property corresponds to a disjunction (logical OR) of the following Allen temporal relations (Allen, 1983): {before, meets, overlaps, starts, during}.

This property is transitive.



Figure 22: Temporal entity A ends before the end of temporal entity B. Here A is longer than B



Figure 23: Temporal entity A ends before the end of temporal entity B. Here A is shorter than B

Examples:

© Godstow Abbey, Oxfordshire as a working abbey (E4 Period) ends before the end of the reign of Henry VIII (E4 Period).

Formatted: CRM Example, Indent: Before: 1", Hanging: 0.13", Outline numbered + Level: 4 + Numbering Style: Bullet + Aligned at: 1.75" + Tab after: 0" + Indent at: 2"

In First Order Logic:

$P185(x,y) \Rightarrow E2(x)$
 $P185(x,y) \Rightarrow E2(y)$
 $P185(x,y) \Rightarrow P184(x,y)$
 $[P185(x,y) \wedge P185(y,z)] \Rightarrow P185(x,z)$

P186 produced thing of product type (is produced by)

Domain:

E12 Production

Field Code Changed

Range:

E99 Product Type

Field Code Changed

Quantification:

many to many (0,n:0,n)

Formatted: French (France)

Scope note:

This property associates an instance of E12 Production with the instance of E99 Production Type, that is, the type of the things it produces.

Examples:

- The production activity of the Volkswagen factory related to the “Standard limousine Type II” during 1949-1953 (E12) produced thing of product type Volkswagen Type 11 (Beetle) (E99). (Rieger, 2013)

In First Order Logic:

$P186(x,y) \Rightarrow E12(x)$
 $P186(x,y) \Rightarrow E99(y)$
 $P186(x,y) \Rightarrow (\exists z) [E24(z) \wedge P108(x,z) \wedge P2(z,y)]$

P187 has production plan (is production plan for)

Domain:

E99 Product Type

Range:

E29 Design or Procedure

Quantification:

one to many (1,n:1,1)

Scope note:

This property associates an instance of E99 Product Type with an instance of E29 Design or Procedure that completely determines the production of instances of E18 Physical Thing. The resulting instances of E18 Physical Thing are considered exemplars of this instance of E99 Product Type when the process specified is correctly executed. Note that the respective instance of E29 Design or Procedure may not necessarily be fixed in a written/graphical form, and may require the use of tools or models unique to the product type. The same instance of E99 Product Type may be associated with several variant plans.

Examples:

- Volkswagen Type 11 (Beetle) (E99) *has production plan* the production plans for Volkswagen Type 11 (Beetle) (E29). (Rieger, 2013)

In First Order Logic:

$P187(x,y) \Rightarrow E99(x)$

$P187(x,y) \Rightarrow E29(y)$

P188 requires production tool (is production tool for)

Domain:

E99 Product Type

Range:

E19 Physical Object

Quantification:

one to many (1,n:1,1)

Scope note:

This property associates an instance of E99 Product Type with an instance of E19 Physical Object that is needed for the production of an instance of E18 Physical Thing. When the process of production is correctly executed in accordance with the plan and using the specified instance of E19 Physical Object, the resulting instance of E18 Physical Thing is considered an exemplar of this instance of E99 Product Type. The instance of E19 Physical Object may bear distinct features that are transformed into characteristic features of the resulting instance of E18 Physical Thing. Examples include models and moulds.

Examples:

- Volkswagen Type 11 (Beetle) (E99) *requires production tool* the luggage compartment lid mould for the Volkswagen Type 11 (Beetle) (E22). [See thumbnail image of the luggage compartment lid:
[https://upload.wikimedia.org/wikipedia/commons/thumb/b/b5/Volkswagen_Type_1_\(Auto_classique_St._Lazare_%2710\).jpg/220px-Volkswagen_Type_1_\(Auto_classique_St._Lazare_%2710\).jpg](https://upload.wikimedia.org/wikipedia/commons/thumb/b/b5/Volkswagen_Type_1_(Auto_classique_St._Lazare_%2710).jpg/220px-Volkswagen_Type_1_(Auto_classique_St._Lazare_%2710).jpg)] (Rieger, 2013)

In First Order Logic:

$P188(x,y) \Rightarrow E99(x)$

$P188(x,y) \Rightarrow E19(y)$

P189 approximates (is approximated by)

Domain:

E53 Place

Range:

E53 Place

Quantification:

many to many (0,n:0,n)

Scope note:

This property associates an instance of E53 Place with another instance of E53 Place, which is defined in the same reference space, and which is used to approximate the former. The property does not necessarily state the quality or accuracy of this approximation, but rather indicates the use of the first instance of place to approximate the second.

In common documentation practice, find or encounter spots e.g., in archaeology, botany or zoology are often related to the closest village, river or other named place without detailing the relation, e.g., if it is located within the village or in a certain distance of the specified place. In this case the stated “phenomenal” place found in the documentation can be seen as approximation of the actual encounter spot without more specific knowledge.

In more recent documentation often point coordinate information is provided that originates from GPS measurements or georeferencing from a map. This point coordinate information does not state the actual place of the encounter spot but tries to approximate it with a “declarative” place. The accuracy depends on the methodology used when creating the coordinates. It may be dependent on technical limitations like GPS accuracy but also on the method where the GPS location is taken in relation to the measured feature. If the methodology is known a maximum deviation from the measured point can be calculated and the encounter spot or feature may be related to the resulting circle using an instance of *P171 at some place within*.

This property is not transitive.

Examples:

- [40°31'17.9"N 21°15'48.3"E] (E53) *approximates* Kastoria, Greece, TGN ID: 7010880 (E53). [The approximating declarative place with point shape is defined in terms of coordinates taken from <https://sws.geonames.org/735927/>]
- [40°31'00.1"N 21°16'00.1"E] (E53) *approximates* Kastoria, Greece, TGN ID: 7010880 (E53). [The approximating declarative place with point shape is defined in terms of coordinates taken from <http://vocab.getty.edu/page/tgn/7010880>]
- [40°04'60.0"N 22°21'00.0"E] (E53) *approximates* Mount Olympus National Park, Greece (E53). [The approximating declarative place with point shape is defined in terms of coordinates taken from <https://www.geonames.org/6941814/>]

In First Order Logic:

$P189(x,y) \Rightarrow E53(x)$

$P189(x,y) \Rightarrow E53(y)$

$P189(x,y,z) \Rightarrow [P189(x,y) \wedge E55(z)]$

Properties:

P189.1 has type: E55 Type

P190 has symbolic content

Domain:

E90 Symbolic Object

Range:

E62 String

Subproperty of:

E1 CRM Entity. P3 has note: E62 String

Quantification:

many to many (0,n:0,n)

Scope note:

This property associates an instance of E90 Symbolic Object with a complete, identifying representation of its content in the form of an instance of E62 String.

This property only applies to instances of E90 Symbolic Object that can be represented completely in this form. The representation may be more specific than the symbolic level defining the identity condition of the represented. This depends on the type of the symbolic object represented. For instance, if a name has type "Modern Greek character sequence", it may be represented in a loss-free Latin transcription, meaning however the sequence of Greek letters.

As another example, if the represented object has type "English words sequence", American English or British English spelling variants may be chosen to represent the English word "colour" without defining a different symbolic object. If a name has type "European traditional name", no particular string may define its content.

Examples:

- The materials description of the painting (E33) *has symbolic content* "Oil, French Watercolors on Paper, Graphite and Ink on Canvas, with an Oak frame." (E62).
- The title of Einstein's 1915 text (E35) *has symbolic content* "Relativity, the Special and the General Theory" (E62). (Einstein, 2001)
- The story of Little Red Riding Hood (E33) *has symbolic content* "Once upon a time there lived in a certain village." (E62). (Lang, 1965)
- The inscription on Rijksmuseum object SK-A-1601 (E34) has symbolic content "B" (E62). [reference: <https://www.rijksmuseum.nl/en/collection/SK-A-1601/catalogue-entry> (accessed 10th April 2021)]

In First Order Logic:

$P190(x,y) \Rightarrow E90(x)$

$P190(x,y) \Rightarrow E62(y)$

P191 had duration (was duration of)

Domain:

E52 Time-Span

Range:

E54 Dimension

Quantification:

one to one (1,1:1,1)

Scope note:

This property describes the length of time covered by an instance of E52 Time-Span. It allows an instance of E52 Time-Span to be associated with an instance of E54 Dimension representing duration independent from the actual beginning and end. Indeterminacy of the duration value can be expressed by assigning a numerical interval to the property *P90 has value* of E54 Dimension.

Examples:

- The time span of the Battle of Issos 333 B.C.E. (E52) *had duration* Battle of Issos duration (E54). (Howard, 2012)

In First Order Logic:

$P191(x,y) \Rightarrow E52(x)$

$P191(x,y) \Rightarrow E54(y)$

P195 was a presence of (had presence)

Domain:

E93 Presence

Range:

E18 Physical Thing

Quantification:

many to one, necessary (1,1 : 0,n)

Scope note:

This property associates an instance of E93 Presence with the instance of E18 Physical Thing of which it represents a temporal restriction (i.e.: a time-slice) of the thing's trajectory through spacetime. In other words, it describes where the instance of E18 Physical Thing was or moved around within a given time-span. Instantiating this property constitutes a necessary part of the identity of the respective instance of E93 Presence.

This property is a strong shortcut of the fully developed path from E18 Physical Thing through *P196 defines*, E92 Spacetime Volume, *P166 was a presence of (had presence)* to E93 Presence.

Examples:

- Johann Joachim Winckelmann's whereabouts in December 1755 (E93) *was a presence of* Johann Joachim Winckelmann (E21). (Wiencke, 1998)
- Johann Joachim Winckelmann's whereabouts from 19th November 19 1755 until 9th April 1768 (E93) *was a presence of* Johann Joachim Winckelmann (E21). (Wiencke, 1998)

In First Order Logic:

$P195(x,y) \Rightarrow E93(x)$

$P195(x,y) \Rightarrow E18(y)$

$P195(x,y) \Leftrightarrow (\exists z)[E92(z) \wedge P166(z,x) \wedge P196i(z,y)]$

P196 defines (is defined by)

Domain:

E18 Physical Thing

Range:

E92 Spacetime Volume

Quantification:

one to one, necessary (1,1:0,1)

Scope note:

This property associates an instance of E18 Physical Thing with the instance of E92 Spacetime Volume that constitutes the complete trajectory of its geometric extent through spacetime for the whole time of the existence of the instance of E18 Physical Thing.

An instance of E18 Physical Thing not only occupies a particular geometric space at each instant of its existence, but in the course of its existence it also forms a trajectory through spacetime, which occupies a real, that is phenomenal, volume in spacetime, i.e., the instance of E92 Spacetime Volume this property associates it with. This real spatiotemporal extent of the instance of E18 Physical Thing is regarded as being unique, in all its details and fuzziness; the identity and existence of the E92 Spacetime Volume depends uniquely on the identity of the instance of E18 Physical Thing, whose existence defines it. It constitutes a phenomenal spacetime volume as defined in CRMgeo (Doerr & Hiebel, 2013).

Included in this spacetime volume are both the spaces filled by the matter of the physical thing and any inner space that may exist, for instance the interior of a box. Physical things consisting of aggregations of physically unconnected objects, such as a set of chessmen, occupy a finite number of individually contiguous subsets of this spacetime volume equal to the number of objects that constitute the set and that are never connected during its existence.

Examples:

- H.M.S. Temeraire (E22) *defines* the spacetime volume of H.M.S. Temeraire (E92). [it was built, during 1798, in Chatham and destroyed, during 1838, in Rotherhithe] (Willis, 2010)
- The Saint Titus reliquary (E22) *defines* the Spacetime Volume of the Saint Titus reliquary (E92). [the reliquary has been produced by the workshop of the Vogiatzis brothers located at Monastiraki, Athens, in 1966 as container for the skull of Saint Titus, which was placed into it at that time and has since then continued to fall within the container's spacetime volume. The reliquary with the skull has been kept in the Saint Titus Church in Heraklion, Crete since 1966] (Fisher & Garvey, 2010) (Panotis, 2016)

In First Order Logic:

$P196(x,y) \Rightarrow E18(x)$

$P196(x,y) \Rightarrow E92(y)$

P197 covered parts of (was partially covered by)

Domain:

E93 Presence

Range:

E53 Place

Quantification:

many to many (0,n;0,n)

Scope note:

This property associates an instance of E93 Presence with an instance of E53 Place that geometrically overlaps with the spatial projection of the respective instance of E93 Presence. A use case of this property is to state through which places an object or an instance of E21 Person has or was moved within a given time-span. It may also be used to describe a partial or complete, temporary or permanent extension of the spatial extent of some realm into a neighbouring region during a known time-span. It may also be used to describe a partial or

complete, temporary or permanent extension of the spatial extent of some realm into a neighbouring region during a known time-span.

This property is a shortcut of the more fully developed path from E93 Presence through *P161 has spatial projection*, E53 Place, *P121 overlaps with*, to E53 Place.

Examples:

- Johann Joachim Winckelmann's whereabouts from 19th November 19 1755 until 9th April 1768 (E93) *covered parts of* Paestum, Italy (E53). (Wiencke, 1998)
- The Byzantine Empire 1013 AD (E93) *covered parts of* The Italian Peninsula (E53). (Browning, 1980)

In First Order Logic:

$P197(x,y) \Rightarrow E93(x)$

$P197(x,y) \Rightarrow E53(y)$

P198 holds or supports (is held or supported by)

Domain:

E18 Physical Thing

Range:

E18 Physical Thing

Quantification:

one to many (0,n:0,n)

Scope Note:

This property relates one instance of E18 Physical Thing which acts as a container or support to a supported or contained instance of E18 Physical Thing. Typical examples of E18 Physical Things which are intended to function as a container or support include shelves, folders or boxes. These containers or supports provide a stable surface which is intended for other physical objects to be placed upon for storage, display, transport or other similar functions.

This property is a shortcut of the more fully developed path from E18 Physical Thing through *P59 has section*, E53 Place, *P53i is former or current location of*, to E18 Physical Thing. It is not a sub-property of P46 is composed of, as the held or supported object is not a component of the container or support.

This property can be used to avoid explicitly instantiating the E53 Place which is defined by an instance of E18 Physical Thing, especially when the only intended use of that instance of E18 Physical Thing is to act as a container or surface for the storage of other instances of E18 Physical Thing. The place's existence is defined by the existence of the container or surface, and will go out of existence at the same time as the destruction of the container or surface.

This property is transitive.

Examples:

- Archival folder "6" (E22) *holds or supports* the piece of paper carrying the text of a letter from Lawrence Alloway to Sylvia Sleight (E22).
[http://archives2.getty.edu:8082/xtf/view?docId=ead/2003.M.46/2003.M.46.xml;chunk.id=a_space_ref12_kf7;brand=default]
- Archival folder "17" (E22) *holds or supports the* daguerreotype that shows the image of Henry Ward Beecher as a young man (E22).
[https://archives.yale.edu/repositories/12/archival_objects/14022661]

- Box "88" (E22) *holds or supports* folder "17" (E22).
[https://archives.yale.edu/repositories/12/archival_objects/1402266]
- Bookshelf "GRI-708.1" (E22) *holds or supports* the book entitled "Catalog of Paintings in the J. Paul Getty Museum" (E22). (Potts, 2015)

In First Order Logic:

$P198(x,y) \Rightarrow E18(x)$

$P198(x,y) \Rightarrow E18(y)$

$[P198(x,y) \wedge P198(y,z)] \Rightarrow P198(x,z)$

$[P198(x,y) \wedge P198(z,y)] \Rightarrow [P198(x,z) \vee P198(z,x)]$

$P198(x,y) \Leftarrow (\exists z) [E53(z) \wedge P59(x,z) \wedge P53i(z,y)]$

P199 represents instance of type

Domain:

[E36 Visual Item](#)

Range:

[E55 Type](#)

Subproperty of:

[P138 represents \(has representation\)](#)

Quantification:

Scope note:

[This property establishes the relationship between an instance of E36 Visual Item and an instance of E55 Type that characterises the thing depicted. This property is used when the identity of the thing depicted is unknown or unrecorded, but is clearly a particular thing of that type. If the instance of E36 Visual Item directly depicts the concept of the E55 Type rather than an instance of a thing of that type, then this should be represented using E36 Visual Item P138 represents E55 Type.](#)

[This property is a shortcut of the more fully developed path from E36 Visual Item through P138 represents, E1 CRM Entity, P2 has type, E55 Type.](#)

Examples:

- [The visual content of photograph gri_2012_m_2_b001_f001_d01_e005_0148 \(E36\) represents instance of type automobile \(E55\). \[Reference: <https://www.getty.edu/research/collections/object/10062J>\]](#)
- [The top right image on page 87 in the book 'Pharaoh's Birds' by John Miles \(E36\) represents instance of type hoopoe \(Upupa epops\) \(E55\). \[This image is a reproduction of a photograph. The same book shows at the top of page 35 an image representing an unnamed ancient Egyptian relief depicting a hoopoe and other 'Birds of the Marshes'. In contrast to the photograph, the latter image of the ancient Egyptian depiction shows intentionally typical rather than individual characteristics of the respective species, and should therefore be associated with the property P138 represents with the species name hoopoe \(Upupa epops\)\]. \(Miles, 1998\)](#)
- [The visual content of Monet's painting from 1868-1869 held by Musée d'Orsay, Paris, under inventory number RF 1984 164 \(E36\) represents instance of type magpie \(Pica pica\) \(E55\). \[The editors give this example under the assumption that Claude Monet, as impressionist, created the painting following a real impression of a particular magpie. It was clearly not meant as a prototypical representation of this bird\] \(Musée d'Orsay, 2020\)](#)
- [The top image on page 44 in the book 'Wildblumen Kretas' by Vangelis Papiomytoglou \(E36\) represents instance of type Cistus creticus L. \(E55\). \[This image is a reproduction of a photograph. The plant produces an aromatic resin that has been exported from Crete to Egypt and other areas since the Bronze Age\] \(Papiomytoglou, 2006\)](#)

In First Order Logic:

Works Cited

- Acel, A. D. (2007) *The artist and the mathematician: the story of Nicolas Bourbaki, the genius mathematician who never existed*. London: High Stakes.
- Adkin, M. (2005) *The Trafalgar companion: a guide to history's most famous sea battle and the life of Admiral Lord Nelson*. London: Aurum Press Ltd.
- Aldridge, R. (2008) *The Sinking of the Titanic*. New York: Infobase Pub.
- Alighieri, D. (1956) *La Divina Commedia: Inferno*. New York: Folways Records.
- Allen, J. F. (1983) 'Maintaining knowledge about temporal intervals', *Communications of the ACM*, 26(11), pp. 832–843. doi: [10.1145/182.358434](https://doi.org/10.1145/182.358434).
- Andrews, I. and Kesteven, P. (1977) *Defeat in the forest*. London: Cambridge Press.
- Atlas, R. D. (2001) 'ENRON'S COLLAPSE: THE OPTIONS; A Trend Toward Liquidation, Not Company Reorganization', *The New York Times*, 30 November. Available at: <https://www.nytimes.com/2001/11/30/business/enron-s-collapse-options-trend-toward-liquidation-not-company-reorganization.html> (Accessed: 4 February 2021).
- Ball, D. W. (1962) *Maxwell's equations of electrodynamics: an explanation*. Washington: Spie Press.
- Barber, N. (1994) *World War II*. Great Britain: Evans.
- Barber, R. L. N. (1999) *Athens*. London: A. & C. Black.
- Barnard, H. et al. (2007) 'Mixed results of seven methods for organic residue analysis applied to one vessel with the residue of a known foodstuff', *Journal of Archaeological Science*, 34(1), pp. 28–37. doi: [10.1016/j.jas.2006.03.010](https://doi.org/10.1016/j.jas.2006.03.010).
- Barton, S. J. (1992) *The study of an electrically insulating resin for humid environments*. Kingston University Press.
- Beckman, O. (1998) 'Celsius, Linne and the Celsius Temperature Scale', *Bulletin of the Scientific Instrument Society*, 56, pp. 17–23.
- Bekiari, C. et al. (eds) (2015) *FRBR, object-oriented definition and mapping from FRBRER, FRAD and FRASAD*. Available at: http://www.cidoc-erm.org/frbroo/sites/default/files/FRBRoo_V2.4.pdf (Accessed: 6 February 2021).
- Benaki Museum (2016) *Childhood, Toys and Games - Benaki Museum*. Available at: https://www.benaki.org/index.php?option=com_collections&view=collection&id=45&Itemid=540&lang=en (Accessed: 5 February 2021).
- Berkoff, S. (2013) *Sturm und Drang*. London: Bloomsbury. Available at: <http://dx.doi.org/10.5040/9780571291168.00000104> (Accessed: 5 February 2021).
- Berlin Wall built* (no date) *HISTORY*. Available at: <https://www.history.com/this-day-in-history/berlin-wall-built> (Accessed: 6 February 2021).
- Bertaud, J.-P. (2004) *La révolution française*. Paris: Perrin.
- Bieber, M. (1961) *The Sculpture of the Hellenistic Age - Revised Edition*. New York: Columbia University Press.
- Black, J. (2010) *The Battle of Waterloo*. New York: Random House.
- Blake, S. F. (1918) 'Notes on the Clayton Herbarium', *Rhodora*, 20(230), pp. 21–28, 48–54, 65–73.
- Bleicken, J. and Bell, A. (2015) *Augustus: the biography*. London: Allen Lane.
- Bonney, R. (2014) *The Thirty years' war: 1618-1648*. Oxford: Osprey.
- Borchert, T.-H. (2008) *Jan van Eyck*. London: Taschen.
- Bortolatto, L. R. (1981) *Tout l'œuvre peint de Monet: 1870-1889*. Paris: Flammarion Groupe.
- Boyd, M. J. (2002). *Middle Helladic and early Mycenaean mortuary practices in the southern and western Peloponnese*. Oxford, Archaeopress.

- Boyer, M. (1959) *Japanese export lacquers from the seventeenth century in the National Museum of Denmark*. København: National Museum.
- Braithwaite, A. (1977) *Bath from Roman time*. Cambridge: Dinosaur Publications for Bath City Council.
- Brandreth, G. (2004) *Philip & Elizabeth: Portrait of a marriage*. London: Arrow.
- Brandstetter, G. and Klein, G. (2015) *Methoden der Tanzwissenschaft: Modellanalysen zu Pina Bauschs 'Le Sacre du Printemps/Das Frühlingsopfer'*. Bielefeld: Transcript.
- Breasted, J. H. (1906) *Ancient records*. Chicago: University of Chicago Press.
- Brickhill, P. (2001) *Reach for the sky: the story of Douglas Bader, legless ace of the Battle of Britain*. Annapolis, Md.: Naval Institute Press.
- Brilliant, R. (2000) *My Laocoön: alternative claims in the interpretation of artworks*. Berkeley: Univ. of California Press.
- Briquet, C.-M. (1985) *Les filigranes: dictionnaire historique des marques du papier : dès leur apparition vers 1282 jusqu'en 1600*. New York: Hacker art Books.
- British Museum (1972) *Treasures of Tutankhamun*. London: British Museum.
- British Museum and Hill, G. F. (1922) *Catalogue of the Greek coins of Arabia, Mesopotamia and Persia (Nabataea, Arabia Provincia, S. Arabia, Mesopotamia, Babylonia, Assyria, Persia, Alexandrine empire of the East, Persis, Elymais, Characene)*. London: British Museum.
- Britton, A. (2012) *RMS Queen Mary*. Stroud, Gloucestershire: The History Press Ltd.
- Brooks, J. A. (1973) *Glass*. New York: Golden Press.
- Brown, L. and Hort, L. (2006) *Nelson Mandela*. New York: Dorling Kindersley.
- Browning, R. (1980) *The Byzantine Empire*. London: Weidenfeld and Nicolson.
- Brueggemann, W. (1982) *Genesis: a Bible commentary for teaching and preaching*. Atlanta: John Knox Press.
- Bryant, J. (1990) *The Iveagh Bequest, Kenwood*. London: English Heritage Guidebooks.
- Bürger, O. (1892) 'Zur Systematik der Nemertinenfauna des Golfs von Neapel', *Nachrichten von der königlichen Gesellschaft der Wissenschaften und der Georg-Augusts-Universität zu Göttingen*, 5, pp. 137–178.
- Butson, T. G. (1986) *Mikhail Gorbachev*. New York: Chelsea House.
- Cali, J., Dougill, J. and Ciotti, G. (2012) *Shinto shrines: a guide to the sacred sites of Japan's ancient religion*. Honolulu: University of Hawai'i Press.
- Camardo, D. (2013) 'Herculaneum from the ad 79 eruption to the medieval period: analysis of the documentary, iconographic and archaeological sources, with new data on the beginning of exploration at the ancient town I', *Papers of the British School at Rome*, 81, pp. 303–340. doi: [10.1017/S0068246213000123](https://doi.org/10.1017/S0068246213000123).
- Carrington, N. T. (1954) *Shakespeare: Cymbeline*. London: J. Brodie.
- Carroll, L. (1981) *Jabberwocky: and other poems*. London: Macmillan Children's Books.
- Carter, H. (2014) *The tomb of Tutankhamun*. London: Bloomsbury Academic.
- Carter, H. and Mace, A. C. (1977) *The discovery of the tomb of Tutankhamen*. New York: Dover Publications.
- Cartwright, M. (2020) 'Battle of Agincourt', *Ancient History Encyclopedia*. Available at: https://www.ancient.eu/Battle_of_Agincourt/Casson.
- Chan, H. (2011) *Ming Taizu (r.1368-98) and the foundation of the Ming Dynasty in China*. Farnham: Ashgate.
- Chester, D. (2001) 'The 1755 Lisbon earthquake', *Progress in Physical Geography: an international review of geographical work in the natural and environmental sciences*, 25(3), pp. 363–383.
- Childe, V. G. (1963) *The bronze age*. New York: Biblo and Tannen.
- Chipp, H. B. (1988) *Picasso's Guernica: history, transformations, meanings*. Berkeley: University of California Press.
- Clare, J. D. and Edwards, M. (1992) *I was there: Roman Empire*. London: The Bodley Head.

- Collectif & Musée d'art et d'histoire Louis-Senlecq (1900) *Les trésors des princes de Bourbon Conti*. Paris: Somogy éditions d'art.
- Construction of massive seawall completed in Shizuoka (no date) *The Asahi Shimbun*. Available at: <http://www.asahi.com/ajw/articles/13257178> (Accessed: 6 February 2021).
- Cooper, B. L. (2008) 'Audio Reviews, Blue Suede Shoes: A Rockabilly Session by Carl Perkins and friends.', *Popular Music and Society*, 31(3), pp. 395–401. doi: 10.1080/03007760802021093.
- Correll, J. L. (1972) *Welcome to the land of the Navajo: a book of information about the Navajo Indians*. 3rd edn. Arizona: Window Rock.
- Courtney Banks, E. (2013). *The Settlement and Architecture of Lerna IV; Results of excavations conducted by the American School of Classical Studies at Athens*, 6. Princeton: American School of Classical Studies at Athens.
- Cox, N. (2000) *Cubism*. London: Phaidon.
- Craig, N. C. and Gislason, E. A. (2002) 'First Law of Thermodynamics; Irreversible and Reversible Processes', *Journal of Chemical Education*, 79(2), p. 193. doi: 10.1021/cd079p193.
- Crocker, B. (2012) *Betty Crocker vegetarian cooking*. Hoboken, N.J.: Wiley.
- Crofton, I. (2015) *Walking the border: a journey between Scotland and England*. Edinburgh: Birlinn.
- Curry, A. (2015) *The battle of Agincourt: sources and interpretations*. Woodbridge, Suffolk: The Boydell Press.
- Dalrymple, W. and Anand, A. (2017) *Koh-I-Noor: the history of the world's most infamous diamond*. London: Bloomsbury.
- Daly, A. (1981) *Royal wedding*. Loughborough: Ladybird Books.
- Daniel, B. C. (2014) 'A graceful return of the drachma', *European Economic Review*, 71, pp. 228–243. doi: 10.1016/j.euroecorev.2014.08.004.
- Dawson, P. L. (2018) *Waterloo: the truth at last: why Napoleon lost the great battle*. Barmsey: Frontline Books.
- Delacroix, E. and Toussaint, H. (1982) *La Liberté guidant le peuple de Delacroix: [catalogue d'une exposition présentée au Musée du Louvre, 5 nov. 1982 au 7 fév. 1983]*. Paris: Réunion des Musées Nationaux.
- Deutsch, O. E. (1965) *Mozart, a documentary biography*. Stanford: Stanford University Press.
- Dewey, D. (2003) 'The Little Mermaid', *Scandinavian Review*, 91(1), p. 34.
- Dodge, B. O. (1933) *Penicillium brefeldianum B.O.Dodge*. In: *Mycologia* 25(2): 92.
- Doerr, M. (2003) *The CIDOC conceptual reference module: an ontological approach to semantic interoperability of metadata*. AI Magazine, 24, 3 (September 2003), pp. 75–92.
- Doerr, M. and Hiebel, G. (2013) 'CRMgeo: Linking the CIDOC CRM to GeoSPARQL through a Spatiotemporal Refinement', *TECHNICAL REPORT: ICS-FORTH/TR-435*. Institute of Computer Science, Foundation for Research and Technology Hellas, Heraklion, Crete, Greece.
- Dolan, J. W. (2005) 'The Bermuda Triangle', *LC GC North America*, 23(4), pp. 370–375.
- Dorman Long (Firm) (1932) *Sydney Harbour Bridge*. Middlesbrough, England: Dorman Long and Company Limited.
- Droste, M. and Gössel, P. (2006) *Bauhaus 1919-1933: reform and Avant-Garde*. Köln: Taschen.
- Edwards, I. E. S. and Boltin, L. (1979) *Tutankhamun: his tomb and its treasures*. London: Gollancz.
- Einstein, A. (2001) *Relativity: the special and the general theory*. London: Routledge.
- Encyclopedia Britannica, the Editors (1998) '*Adoration of the shepherds*'. Encyclopedia Britannica. Available at: <https://www.britannica.com/topic/adoration-of-the-shepherds-religious-motif> (Last edit: 1 March 2018. Accessed: 6 February 2021).
- Evans, A. (1921) *The palace of Minos: a comparative account of the successive stages of the early Cretan civilization as illustrated by the discoveries at Knossos*. London: Macmillan & Co.
- Farnie, D. A. (1980) *The Manchester Ship Canal and the rise of the Port of Manchester, 1894-1975*. Manchester: Manchester University Press.

- Farrand, M. (1913) *Framing of Constitution of United States*. United States: Yale University Press.
- Fisher, J. and Garvey, G. (2010) *The rough guide to Crete*. UK: Rough Guides Limited.
- Foster, N. (2000) *Rebuilding the Reichstag*. Woodstock, N.Y.: Overlook Press.
- Galeotti, M. (1997) *Gorbachev and His Revolution*. London: Macmillan Education, Limited.
- Gangemi, A. *et al.* (2002) 'Sweetening Ontologies with DOLCE', in Gómez-Pérez, A. and Benjamins, V. R. (eds) *Knowledge Engineering and Knowledge Management: Ontologies and the Semantic Web*. Berlin, Heidelberg: Springer (Lecture Notes in Computer Science), pp. 166–181. doi: [10.1007/3-540-45810-7_18](https://doi.org/10.1007/3-540-45810-7_18).
- Gannett, H. and Geological Survey (U.S.) (1904) *Boundaries of the United States and of the several states and territories: with an outline of the history of all important changes of territory*. Washington, D.C.: Department of the Interior, United States Geological Survey.
- George, A. R. (2000) 'Review of The Final Sack of Nineveh. The Discovery, Documentation, and Destruction of King Sennacherib's Throne Room at Nineveh, Iraq', *Journal of the Royal Asiatic Society*, 10(1), pp. 84–85.
- Georgoula, E. (2005) *Greek treasures from the Benaki Museum in Athens*. Sydney: Powerhouse Publishing in association with Benaki Museum.
- Gergatsoulis, M. *et al.* (2010) 'Mapping Cultural Metadata Schemas to CIDOC Conceptual Reference Model', in *Artificial Intelligence: Theories, Models and Applications. Hellenic Conference on Artificial Intelligence*, Springer, Berlin, Heidelberg, pp. 321–326. doi: [10.1007/978-3-642-12842-4_37](https://doi.org/10.1007/978-3-642-12842-4_37).
- Gibbon, E. (2013) *The History of the Decline and Fall of the Roman Empire: Edited in Seven Volumes with Introduction, Notes, Appendices, and Index*. Edited by J. B. Bury. Cambridge: Cambridge University Press (Cambridge Library Collection - Classics). doi: [10.1017/CBO9781139333580](https://doi.org/10.1017/CBO9781139333580).
- Gibson, J. L. (1990) *Ian McKellen*. London: Weidenfeld and Nicolson.
- Gimbutas, M. A. (1965) *Bronze age cultures in central and eastern Europe*. Paris: Mouton & Co.
- Gleick, J. (2003) *Isaac Newton*. London; New York: Fourth Estate.
- Goldner, O. and Turner, G. E. (1976) *The making of King Kong: the story behind a film classic*. New York: Ballantine Books.
- Goldscheider, L. (1953) *Michelangelo: paintings, sculpture, architecture*. London: Phaidon Press.
- Goodwin, P. (2015) *HMS Victory: 1765-1812 (first rate ship of the line)*.
- Gregor, H. (1971) *The S.S. Great Britain*. London: Published for the S.S. Great Britain Project by Macmillan.
- Guarino, N. (1998) *Formal Ontology in Information Systems: Proceedings of the 1st International Conference June 6-8, 1998, Trento, Italy*. 1st edn. NLD: IOS Press.
- Gurcke, K. (1987) *Bricks and brickmaking: a handbook for historical archaeology*. Moscow, Idaho: University of Idaho Press.
- Håfors, B. (2010) *Conservation of the wood of the Swedish warship Vasa of a.d. 1628: evaluation of polyethylene glycol conservation programmes*. Acta Universitatis Gothoburgensis.
- Hallam, A. (1975) *Jurassic environment*. Cambridge: Cambridge University Press.
- Hallam, E. M. (1986) *Domesday Book through Nine Centuries*. London: Thames & Hudson. ISBN 0500250979.
- Harbutt, F. J. (2010) *Yalta 1945: Europe and America at the crossroads*. Cambridge: Cambridge University Press.
- Harrison, R. J. (2004) *Symbols and warriors: images of the European Bronze Age*. Bristol: Western Academic & Specialist Press.
- Hartle, J. B. (2003) *Gravity an introduction to Einstein's general relativity*. San Francisco: Addison-Wesley.
- Hau, L. V. *et al.* (1999) 'Light speed reduction to 17 metres per second in an ultracold atomic gas', *Nature*, (6720), pp. 594–597.
- Hawass, Z. (2000) *The Mysteries of Abu Simbel: Ramesses II and the Temples of the Rising Sun*. Cairo: American University in Cairo.

Hegen, E. E. (1966) *Highways into the Upper Amazon Basin: pioneer lands in southern Colombia, Ecuador, and northern Peru*. Gainesville: University of Florida Press.

Hershberger A.J, Robacker C, and Jenkins T.M (2015) 'Molecular genetic variability of *spigelia marilandica* and *S. Gentianoides*', *J. Am. Soc. Hortic. Sci. Journal of the American Society for Horticultural Science*, 140(2), pp. 120–128.

Hiebel, G. and Doerr, M. (2013) 'An ontological spatio-temporal refinement for the CIDOC CRM and GIS standards', in: *19th Annual meeting of the European Association of Archaeologists (EAA2013)*, Pilsen, Czech Republic.

Hilmo, M. (2019) *Medieval Images, Icons, and Illustrated English Literary Texts : From the Ruthwell Cross to the Ellesmere Chaucer*. Aldershot: Ashgate Publishing, Ltd. doi: 10.4324/9781315249278.

Hind, A. M. (1923) *A catalogue of Rembrandt's etchings: chronologically arranged and completely illustrated*. London: Methuen.

Historical Museum of Crete (2005) *Numismatics*. Available at: <https://www.historical-museum.gr/eng/collections/view/nomismatikh-sullogh> (Accessed: 4 March 2021).

Holliday, I., Marcou, G. and Vickerman, R. W. (1991) *The Channel tunnel: public policy, regional development and European integration*. London; New York: Belhaven Press.

Honey, A. and Pickwood, N. (2010) 'Learning from the Past: Using Original Techniques to Conserve a Twelfth-Century Illuminated Manuscript and Its Sixteenth-century Greek-Style Binding at the Monastery of St Catherine, Sinai', *Studies in Conservation*, 55(sup2), pp. 56–61. doi: 10.1179/sic.2010.55.Supplement-2.56.

Hood, S. (1971) *The Minoans: Crete in the Bronze Age*. London: Thames and Hudson (Ancient Peoples and Places, 75).

Hopkins, K. and Beard, M. (2011) *The Colosseum*. Cambridge, MA: Harvard University Press.

Howard, M. (2012) *Alexander the Great: the Story of the Invincible Macedonian King*. London: Bloomsbury Publishing Plc.

Hoyt, E. P. (1993) *199 days: the battle of Stalingrad*. New York: Tor.

Hufford, D. J. and Horwitz, P. (2005) 'Fixing the Hole in the Ozone Layer: A Success in the Making', *Natural Resources and the Environment - Chicago*, 19(4), pp. 8–14.

Humboldt, A. von (1859) *Reise in die Aequinoctial Gegenden des neuen Continents*. Translated by H. Hauff. Stuttgart: J. G. Cotta.

Huray, P. G. (2010) *Maxwell's Equations*. Hoboken, NJ, USA: John Wiley & Sons, Inc.

Iliffe, R. (2013) *Newton: The Making of a Politician, The Newton Project*. Available at: <http://www.newtonproject.ox.ac.uk/view/context/CNTX00002> (Accessed: 6 February 2021).

Ingamells, J. (1990) *The Wallace collection*. London: Scala Books.

~~International Organization for Standardization (1988) *ISO 639. Code for the Representation of Names of Languages*. Geneva, Switzerland: International Organization for Standardization.~~

International Organization for Standardization (1992) *ISO 1000. SI units and recommendations for the use of their multiples and of certain other units*. Geneva, Switzerland: International Organization for Standardization.

~~International Organization for Standardization (1998) *ISO 639-2. Codes for the representation of names of languages –Part 2: Alpha-3 code*. Geneva, Switzerland: International Organization for Standardization.~~

International Organization for Standardization (2013a) *ISO 21127:2014 Information and documentation — A reference ontology for the interchange of cultural heritage information*. 1st edn. Geneva, Switzerland: International Organization for Standardization.

International Organization for Standardization (2013b) *ISO 25964-2:2013. Information and documentation — Thesauri and interoperability with other vocabularies — Part 2: Interoperability with other vocabularies*. 1st edn. Geneva, Switzerland: International Organization for Standardization.

Irwin, W. A. (1935) *The Julius Caesar Murder Case*. New York, London: D. Appleton-Century Co.

Iveagh Bequest (1975) *Catalogue of paintings*. London: Greater London Council.

Isaacson, W. (2011) *Steve Jobs*. USA: Little, Brown.

- Jones, R. F. (1979) *George Washington*. Boston Mass.: Twayne.
- Karetsou A. (ed.). (2000). Kriti – Aigyptos. Politismikoi desmoi trion chilietion. *Athens: Archaeological Museum of Herakleion*.
- Karyanos, P., Lagos, C. and Carr, J. (2020) *Who really won the Battle of Marathon?* UK: Barnsley Pen et Sword Military.
- Kelly, D. (2014) *Machaut and the medieval apprenticeship tradition: truth, fiction and poetic craft*. New York: Brewer.
- Kogan, H. (1958) *The great EB: the story of the Encyclopædia Britannica*. Chicago: University of Chicago Press.
- Kousser, R. (2005) 'Creating the Past: The Venus de Milo and the Hellenistic Reception of Classical Greece', *American Journal of Archeology*, 109(2), pp. 227–250.
- Kouwenhoven, A. P. (1997) 'Newsbriefs: World's Oldest Spears', *Archaeology*, 50(3). Available at: <https://archive.archaeology.org/9705/newsbriefs/spears.html> (Accessed: 6 February 2021).
- Kozak, M. (1998) *Greenpeace*. Oxford: Heinemann Library.
- Krentz, P. (2010) *The Battle of Marathon*. New Haven; London: Yale University Press.
- Kutschera, W. (2002) *Radiocarbon dating of the Iceman Ötzi with accelerator mass spectrometry*. Available at: <https://www.semanticscholar.org/paper/Radiocarbon-dating-of-the-Iceman-%C3%96tzi-with-mass-Kutschera/20d9b3be6466e3a6d51ddb213f9c982fd949024> (Accessed: 6 February 2021).
- Lamb, R. (2005) 'Alexander the Great and Bucephalus', *Horse & Rider*, 44(6), p. 19.
- Lane Fox, R. (2004) *Alexander the Great*. New York: Penguin.
- Lang, A. (ed.) (1965) *The blue fairy book*. Dover Pubs.
- Leach, A. (2017) *Rome*. Cambridge: Polity Press.
- Lee, S. J. (1991) *The Thirty years war*. London; New York: Routledge.
- Lehner, M. and Hawass, Z. A. (2017) *Giza and the pyramids: the definitive history*. Chicago: University of Chicago Press.
- Lennon, J. (1967) *Lucy in the Sky with Diamonds*. London: Northern Songs.
- Leppmann, W. (1970) *Winckelmann*. New York: Knopf.
- Li, X. J. (2012) *Standardisation, labour organisation and the bronze weapons of the Qin terracotta warriors / Xiuzhen Janice Li*. Ph.D. University College London. Available at: <http://discovery.ucl.ac.uk/1350109/> (Accessed: 22 April 2021).
- Liess, R. (1985) 'Der Riss A1 der Straßburger Münsterfassade im Kontinuum der Entwürfe Magister Erwins.', *Kunsthistorisches Jahrbuch Graz*, 21, pp. 47–121.
- Linnean Society of London et al. (1945) *A catalogue of the Linnaean herbarium*. London: Printed for the Linnean Society of London by Taylor & Francis, Ltd.
- Lockwood, L. (2015) *Beethoven's symphonies: an artistic vision*. New York: W. W. Norton & Company.
- Loubiere, C. P. (1995) *L'aventure d'Abou Simbel Texte imprimé le regard d'un Roi-Dieu*. Paris: Publisud.
- Lovell, J. and Kluger, J. (1994) *Lost moon: the perilous voyage of Apollo 13*. Boston: Houghton Mifflin.
- Lowe Fri, M. (2011) *The double axe in Minoan Crete: an experimental study of production and use*. Oxford: Archaeopress.
- Macdonald, F. (1992) *The Italian Renaissance: Teacher's Notes (Collins living history)*. London: Collins Educational.
- Maddox, S. (2015) *Saving Stalin's imperial city historic preservation in Leningrad, 1930-1950*. Bloomington, Indiana: Indiana University Press.
- [Mangini, E. \(2010\). 1000 Words: Giuseppe Penone. ARTFORUM INTERNATIONAL, 49\(2\), 226–228.](#)
- Marion, S. (2004) *Recherches sur l'âge du Fer en Ile-de-France: entre Hallstatt final et La Tène finale ; analyse des sites fouillés ; chronologie et société*. Oxford: John and Erica Hedges Ltd.

- Maunder, E. W. (1900) *The Royal observatory, Greenwich. A glance at its history and work*. London, The Religious tract society.
- McCullough, C. (2005) *The Merchant of Venice*. Basingstoke: Palgrave Macmillan.
- Meghini, C. and Doerr, M. (2018) 'A first-order logic expression of the CIDOC conceptual reference model', *International Journal of Metadata, Semantics and Ontologies*, 13(2), pp. 131–149. doi: [10.1504/IJMSO.2018.098393](https://doi.org/10.1504/IJMSO.2018.098393).
- Mellen, J. (2002) *Seven samurai*. London: BFI Pub.
- Mhaske, S. T. (no date) 'Polycarbonate: Medical applications', *Chemical Weekly*, 56(30), pp. 201–204.
- Milne, A. A. (2012) *The Sunny Side*. The Floating Press.
- Mohen, J.-P., Menu, M. and Mottin, B. (2006) *Mona Lisa: Inside the Painting*. Harry N. Abrams.
- Moholy-Nagy, L. (2012) *The New Vision: Fundamentals of Bauhaus Design, Painting, Sculpture, and Architecture*. Courier Corporation.
- Mommsen, T. (1872) *Corpus inscriptionum Latinarum Vol. 5, Pars 1*. Berolini: Apud Georgium Reimerum.
- Mommsen, T. E. (1941) 'The Venetians in Athens and the Destruction of the Parthenon in 1687', *American Journal of Archaeology*, 45(4), pp. 544–556. doi: [10.2307/499533](https://doi.org/10.2307/499533).
- Monast, J. and Tao, B. (2002) 'In Memoriam: Paul Wellstone (1944-2002)', *Georgetown International Environmental Law Review*, 15, p. 133.
- Morton, H. C. (1994) *The story of Webster's third: Philip Gove's controversial dictionary and its critics*. Cambridge: Cambridge University Press.
- Municipality of Heraklion (no date) *City Hall*. Available at: <https://www.heraklion.gr/en/municipality/city-hall/city-hall.html> (Accessed: 6 February 2021).
- Murdoch, D. H. et al. (2003) *Tutankhamun: the life and death of a pharaoh*. London: Dorling Kindersley.
- Musée d'Orsay (2020) *Claude Monet "La Pie"*. Available at: https://www.musee-orsay.fr/fr/collections/catalogue-des-oeuvres/notice.html?no_cache=1&numid=715 (Accessed: 1 April 2021).
- National Gallery of Victoria (no date) *Portrait group: The singer Farinelli and friends (c. 1750-1752) Jacopo Amigoni*. Available at: <http://www.ngv.vic.gov.au/explore/collection/work/3701/> (Accessed: 6 February 2021).
- Natural History Museum (2021). Data Portal Query on "Clayton Herbarium" created at 2021-02-03 21:48:21.969228 PID <https://doi.org/10.5519/qd.thnwfyx8>. Subset of "Clayton Herbarium" (dataset) PID <https://doi.org/10.5519/0063794>
- [Natural History Museum \(2021\) b. Collection Specimens - Specimens - 1842.12.14.24-27 - Data Portal created at 2010-04-07. https://data.nhm.ac.uk/object/e1bfb1ab-c94e-4e0a-a13c-bc54e03f22e5.](https://data.nhm.ac.uk/object/e1bfb1ab-c94e-4e0a-a13c-bc54e03f22e5)
- Nelson, A. H. (1989) *Cambridge*. Toronto: University of Toronto Press.
- Norman, C. F. W. (1986) *Corrosion of aluminium*. University of Manchester Press.
- ~~Nuessel, F. H. (2000) *The Esperanto language*. New York: Legas.~~
- Ode to joy: theme and 6 variations on Beethoven's Ode to joy, in the style of Bach, Mozart, Mendelssohn, Dvořák, Wagner and Scott Joplin : string orchestra* (1999). Monmouth: Spartan Press.
- Overy, R. (2012) *20th Century*. London: Dorling Kindersley.
- Owen, J. C. (2009) *Forever Amber : the impact of the Amber Room on Russia's cultural stature then, now and in the future*. Dept. of Art and Art History, Masters dissertations, 2009. thesis. Georgetown University. Available at: <https://repository.library.georgetown.edu/handle/10822/552838> (Accessed: 6 February 2021).
- ~~Palmer, L. R. (1980) *The Greek language*. London: Faber.~~
- Panotis, A. (2016) « Η Θείω Πνεύματι κραταιωθείσα Σύνοδος της Κρήτης », *Πανώτης*. Available at: <https://www.panotis.gr/index.php/2016/06/29/the-holy-spirit-stressed-summit-of-crete/> (Accessed: 6 February 2021).
- Paoletti, J. T. and Bagemihl, R. (2015) *Michelangelo's David: Florentine history and civic identity*. New York: Cambridge University Press. Available at: <https://doi.org/10.1017/CBO9781107338784> (Accessed: 6 February 2021).

- Robinson, J. M. (2000) *Buckingham Palace: The Official Illustrated History*. First Edition. London: Royal Collection Trust.
- Rolt, L. T. C. (1971) *The railway museum, York*. British Railways Board.
- Rose, H. et al. (1978) *The US dollar and its role as a reserve currency*. British-North American Research Association.
- Scarratt, K. and Shor, R. (2006) 'The Cullinian Diamond Centennial: A history and Gemological Analysis of Cullinians', *Gems & Gemology*, 42(2), pp. 120–132.
- Shaw, I. (2000) *The Oxford history of ancient Egypt*. Oxford; New York: Oxford University Press.
- Shipway, J. S. et al. (1990) 'The Forth Railway Bridge Centenary 1880-1990: Some Notes on its Design', *Proceedings of the Institution of Civil Engineers*, 88(6), pp. 1079–1107.
- Siegler, M. A. and Smrekar, S. E. (2014) 'Lunar heat flow: Regional perspective of the Apollo landing sites', *Journal of Geophysical Research: Planets*, 119(1), pp. 47–63.
- Sinkevičius, S. and Naruševičius, V. (2002) 'Investigation of anaphase aberrations in Chaffinch (*Fringilla coelebs* Linnaeus, 1758) populations from different regions of Lithuania', *Acta zoologica Lituanica*, 12(1), pp. 3–9.
- Sitwell, S. (2017) *Mozart*. London: Bello.
- Smails, N. W. (1975) *Beautiful Lake Geneva: a collection of views of the many features, both natural and architectural, which lend attractiveness to this charming resort*. Washington: Library of Congress Photoduplication Service.
- Smith, B. and Varzi, A. C. (2000) 'Fiat and bona fide boundaries', *Philosophical and phenomenological research*, pp. 401–420.
- Smith, W. (1844) *Dictionary of Greek and Roman biography and mythology*. London: Taylor and Walton.
- Solomon, B. (2003) *Railway Masterpieces*. David & Charles.
- Spiers, A. and Surene, G. (1854) *The standard pronouncing dictionary of the French and English languages*. New York: Appleton.
- Steinbeck, J. (2000) *The Log from the Sea of Cortez*. New York.
- Stevenson, R. L., Morrison, W. and Mann, W. W. (1909) *Doktoro Jekyll kaj Sinjoro Hyde*. London: The British Esperanto Association.
- Stoneman, R. (2004) *Alexander the Great*. London; New York: Routledge.
- Strano, T. (1953) *Leonard da Vinci*. Milano.
- Strauss, W. L. (1974) *The Complete Drawings of Albrecht Dürer: 1520-1528*. Abaris Books.
- Strong, R. (2005) *Coronation: a history of kingship and the British monarchy*. Harpercollins Pub Limited.
- Syrmas, A. (1896) *Account Book of ship D.S.Skylytysis 28/9/1895-19/10/1896 Captain A.Syrmas*, Book no5; Inventory Number A.E 53/01, Hellenic Literary and Historical Archive (E.L.L.A), Athens. See also: "Archival Corpus" of the European SEALIT project (<http://www.sealitproject.eu/archival-corpus>).
- Temperton, P. (1997) *The euro*. Chichester: Wiley.
- Temple, R. and Temple, O. (2009) *The Sphinx Mystery: The Forgotten Origins of the Sanctuary of Anubis*. Rochester, Vt: Inner Traditions.
- The Oxford English Dictionary: 20 Volume Set*. Second Edition (1989). Oxford, New York: Oxford University Press.
- Thieberger, F. (1947) *King Solomon*. Oxford.
- Thomas, J. (1972) *The Tay Bridge disaster: new light on the 1879 tragedy*. Douglas David & Charles.
- Tingay, P. (2008) *Vienna*. New Holland Publishers.
- Tissandier, G. (1889) *La tour Eiffel de 300 mètres: description du monument, sa construction, ses organes mécaniques, son but et son utilité*. Paris: G. Masson.

- Trell, B. L. (1945) 'The temple of Artemis at Ephesos', *Numismatic Notes and Monographs*, (107), pp. ii–71.
- Tucker, P. (1984) 'The first Impressionist exhibition and Monet's Impression, Sunrise: a tale of timing, commerce and patriotism', *Art History*, 7(4).
- UN Security Council (2002) *Resolution 1441*. Resolution. United Nations Security Council. Available at: <http://digitallibrary.un.org/record/478123> (Accessed: 6 February 2021).
- Unger, H. G. (2015) *Mr. President George Washington and the Making of the Nation's Highest Office*. Cambridge; New York: Da Capo Press, Incorporated Perseus Books Group.
- Venetian Walls of Heraklion* (2020) *YouInGreece.com*. Available at: <https://youingreece.com/heraklion/venetian-walls> (Accessed: 5 February 2021).
- Walberg G. (1992). The Finds at Tell el-Dab'a and Middle Minoan Chronology. *Ägypten und Levante / Egypt and the Levant*, 157-159.
- Walker, M. *et al.* (2009) 'Formal definition and dating of the GSSP (Global Stratotype Section and Point) for the base of the Holocene using the Greenland NGRIP ice core, and selected auxiliary records', *Journal of Quaternary Science: Published for the Quaternary Research Association*, 24(1), pp. 3–17.
- Walker, S. (2004) *The Portland vase*. London: British Museum Press.
- Watrous, L. V. *et al.* (2012) *Archaeological Survey of the Gournia Landscape: A Regional History of the Mirabello Bay, Crete, in Antiquity*. INSTAP Academic Press (Institute for Aegean Prehistory).
- Watson, M. J. (1990) *Cluster compounds of gold and the platinum metals*. Ph.D. University of Oxford. Available at: <https://ethos.bl.uk/OrderDetails.do?uin=uk.bl.ethos.279996> (Accessed: 6 February 2021).
- Wheat, C. (2005) 'The Real Queen(s) of Crime', *CLUES: A Journal of Detection*, 23, pp. 86–90. doi:10.3200/CLUS.23.4.87-90.
- Whittington, H. (1964) *The fall of the Roman Empire*. Greenwich, Conn.: Fawcett.
- Wicks, R. (2014) *Heathrow Airport Manual: Designing, building and operating the world's busiest international airport (Haynes Manual) (Airfield Operations Manual) by Robert Wicks (2014) Hardcover*. UK: Haynes Publishing.
- Wiencke, M. (1998) 'Johann Winckelmann | German art historian', *Encyclopedia Britannica*. Available at: <https://www.britannica.com/biography/Johann-Joachim-Winckelmann> (Last edit: 5 December 2020. Accessed: 5 February 2021).
- Wikipedia (2021) 'Et in Arcadia ego'. Available at: https://en.wikipedia.org/w/index.php?title=Et_in_Arcadia_ego&oldid=1003943423 (Accessed: 5 February 2021).
- Wildfang, F. B. (2005) *Lake Havasu City*. Charleston SC: Arcadia.
- Willis, S. (2010) *The 'Fighting Temeraire': Legend of Trafalgar*. edition. London: Quercus.
- Williams, A. S. (1993) *The Greeks*. Wayland.
- Williams, J. (2020) *Goethe's Faust*. London: Routledge. doi: 10.4324/9781003006121.
- Wilson, M. (1994) *The Impressionists*. Reprint edition. Oxford England; New York: [New York]: Phaidon Press.
- ~~Wilson, R. L. (1983) *English language*. London: Letts.~~
- Woelkerling, W. J., Gustavsen, G. and Myklebost, H. E. (2005) *The coralline red algal herbarium of Mikael Foslie: revised catalogue with analyses*. Trondheim: Kgl. Norske videnskabers selskab, Museet.
- Wolff, A., Gaertner, R. and Maranuk-Rohmeder, M. (1999) *The Cologne Cathedral*. Verlag Kolner Dom.
- Yakel, E. (2000) 'Museums, Management, Media, and Memory: Lessons from the Enola Gay Exhibition', *Libraries and Culture*, 35, pp. 278–310.
- Yerkes, D. (1989) *Webster's Encyclopedic Unabridged Dictionary of the English Language*. Abridged edition. New York: Random House.

Appendix

Deprecated classes and properties

The following is a list of classes and/or properties that have been deprecated between the version 5.0.4 of the CIDOC CRM, which served as community draft for ISO21127:2014, and this release (7.1). While the CIDOC CRM is developed with the principle of monotonic change, attempting to minimize backwards incompatibility through conservative initial modelling as well as modelling evolution, certain revisions inevitably entail changes to the model which will require an update to knowledge bases based on old versions of the ontology, in order to reconcile instances with the current version. The following tables provide information on which classes or properties have been deprecated and will thus require an update to previous official CRM compliant KBs in order to be in accord with the latest version of the standard. The reader will find in the first table, "Deprecated Class Migration Instructions", classes that have been deprecated and the suggested class or primitive replacement for that class. The reader should further refer to the 'deprecated property migration instructions table' in order to see not only the replacements for deprecated properties but also to understand how to build correct new semantic paths between the instances of deprecated classes and the newly suggested replacement classes or primitives. Finally, there are migration instructions where the range of a property has been reduced to a subclass of the previous range.

Deprecated Class Migration Instructions

Table 5: *Deprecated Class Migration Instructions*

Deprecated Class	Migration Instruction
E38 Image	use E36 Visual Item
E40 Legal Body	use E74 Group
E44 Place Appellation	use E41 Appellation
E45 Address	use E41 Appellation, P2 has type: "Address"
E46 Section Definition	use E41 Appellation
E47 Spatial Coordinates	use E94 Space Primitive
E48 Place Name	use E41 Appellation
E49 Time Appellation	use E41 Appellation
E50 Date	use E61 Time Primitive
E51 Contact Point	use E41 Appellation, P2 has type: "Contact Point"
E75 Conceptual Object Appellation	use E41 Appellation
E82 Actor Appellation	use E41 Appellation
E84 Information Carrier	use E22 Human-Made Object, P2 has type: "Information Carrier"

Deprecated Property Migration Instructions

Table 6: Deprecated Property Migration Instructions

Deprecated property	Migration Instruction
<i>P58 has section definition (defines section)</i>	use P1 is identified by (identifies)
<i>P78 is identified by (identifies): E49 Time Appellation</i> [except for instances of E50 Date]	use P1 identified by (identifies): E41 Appellation [for instance, Japanese imperial rule names]
<i>P78 is identified by (identifies): E50 Date</i>	use P170i time is defined by: E61 Time Primitive
<i>P88 consists of (forms part of)</i>	If used as a geometric decomposition, use P89i contains. If the respective place is defined in the source by an instance of E26 Physical Feature, and the use of <i>P88 consists of</i> aims at describing its decomposition into its natural components, describe explicitly in the migration target the instance of E26 Physical Feature and its parts using P46 is composed of
<i>P83 had at least duration (was minimum duration of)</i> and <i>P84 had at most duration (was maximum duration of)</i>	use P191 had duration (was duration of): The instances of E60 Number in the full source paths: E52 Time-Span. <i>P83 had at least duration.</i> E54 Dimension. <i>P90 has value.</i> E60 Number and in E52 Time-Span. <i>P84 had at most duration.</i> E54 Dimension. <i>P90 has value.</i> E60 Number should both be merged in the migration target path into one numerical interval, instance of E60 Number: E52 Time-Span. <i>P191 had duration.</i> E54 Dimension. <i>P90 has value.</i> E60 Number For representing intervals in RDF/OWL encoding see the respective implementation guidelines.
<i>P87 is identified by (identifies): E44 Place Appellation</i> (except for instances of E47 Spatial Coordinates)	use P1 identified by (identifies): E41 Appellation
<i>P87 is identified by (identifies): E47 Spatial Coordinates</i>	use P168i defines place: E94 Space Primitive
<i>P114 is equal in time to*</i>	use the fully developed path from E2 Temporal Entity through P4 has time-span, E52 Time-Span, P4i is time-span of, to E2 Temporal Entity. Theoretically, <i>P114 is equal in time to</i> is equal to the conjunction of: (<i>P175 starts before or with the start of</i> AND <i>P175i starts after or with the start of</i> AND <i>P184 ends before or with the end of</i> AND <i>P184i ends with or after the end of</i>), without fuzzy

	temporal boundaries. However, note that only a common cause or a socially declared time-span can lead to temporal equality of different instances of E2 Temporal Entity. Consequently, creating the full path is always the preferred migration strategy.
<i>P115 finishes (is finished by) *</i>	P176i starts after the start of AND P184 ends before or with the end of AND P184i ends with or after the end of [P176i starts after the start of is required because the Range E2 Temporal Entity must be longer than the Domain E2 Temporal Entity]
<i>P116 starts (is started by) *</i>	P175 starts before or with the start of AND P175i starts after or with the start of AND P185 ends before the end of [P185 ends before the end of is required because the Range E2 Temporal Entity must be longer than the Domain E2 Temporal Entity]
<i>P117 occurs during (includes) *</i>	P176i starts after the start of AND P185 ends before the end of
<i>P118 overlaps in time with (is overlapped in time by) *</i>	P176 starts before the start of AND P185 ends before the end of
<i>P119 meets in time with (is met in time by) *</i>	use P182 ends before or with the start of AND P173i ends after or with the start of
<i>P120 occurs before (occurs after) *</i>	use P183 ends before the start of
<i>P131 is identified by (identifies)</i>	use P1 identified by (identifies)
<i>P149 is identified by (identifies)</i>	use P1 identified by (identifies)
<i>P178 ends after or with (ends before or at the end of)</i>	use P184i ends with or after the end of instead
<i>P181 has amount</i>	E54 Dimension. P90 has value: E60 Number instead

*The properties P114 to P120 have been introduced in the CIDOC CRM extension “Definition of the CRMarchaeo. An Extension of CIDOC CRM to support the archaeological excavation process”, Version 1.5.1, March 2021.

Migration Instructions for the reduced scope of [E81](#) Transformation

From version 7.1.1 on, the class [E81](#) Transformation pertains only to instances of [E18](#) Physical Thing, rather than to instances of [E77](#) Persistent Item. The reason is the insight that only for physical things the form previous to a transformation must cease to exist. For instances of [E28](#) Conceptual Object, any number of copies can be around that are not affected by the transformation. Similarly, transformations of instances of [E74](#) Group do not necessarily cause the dissolution of the previous grouping.

Therefore, the properties [P123](#) *resulted in (resulted from)* and [P124](#) *transformed (was transformed by)* now have the range: [E18](#) Physical Thing.

If these properties were applied in the source to instances of [E28](#) Conceptual Object or its subclasses, use in the migration target [E65](#) Creation instead of [E81](#) Transformation, [P94](#) *has created (was created by)* instead of [P123](#).

resulted in (resulted from), and [P16](#) used specific object (was used for) instead of [P124](#) transformed (was transformed by).

If these properties were applied in the source to instances of [E74](#) Group, use in the migration target [E66](#) Formation instead of [E81](#) Transformation, [P95](#) has formed (was formed by) instead of [P123](#) resulted in (resulted from), and [P151](#) was formed from (participated in) instead of [P124](#) transformed (was transformed by).

Migration Instructions for the reduced scope of [E16](#) Measurement

From version 7.1.1 on, the class [E16](#) Measurement pertains only to instances of [E18](#) Physical Thing, rather than to instances of [E1](#) CRM Entity. The reason is twofold. Firstly, the property [P43](#) has dimension (is dimension of) associates a dimension only with [E70](#) Thing, and thereby only allows for documenting the results of the measuring of instances of [E70](#) Thing. Secondly, in the narrower sense, only physical things can be observed for quantitative measurements, but instances of [E54](#) Dimension, in particular for instances of [E28](#) Conceptual Object, may be inferred by other forms of [E13](#) Attribute Assignment, such as data evaluation. Therefore, the property [P39](#) measured (was measured by) now has the range: [E18](#) Physical Thing.

If this property was applied in the source to instances of [E28](#) Conceptual Object or its subclasses, use in the migration target [E13](#) Attribute Assignment instead of [E16](#) Measurement, [P140](#) assigned attribute to (was attributed by) instead of [P39](#) measured (was measured by), [P141](#) assigned (was assigned by) instead of [P40](#) observed dimension (was observed in), and [P177](#) assigned property of type (is type of property assigned): "P43 has dimension (is dimension of)" ([E55](#)).

Amendments

The amendments can be found in "Amendments of the CIDOC Conceptual Reference Model ver. 7.1.1: volume B"