

CIDOC CRM 101 with Notre-Dame de Paris

Anaïs Guillem

57th joint meeting of the CIDOC CRM SIG, 50th FRBR/LRMoo SIG

Pedagogical material revamped from:
CIDOC CRM as a Language for Cultural Heritage Level A1

George Bruseker - Takin.solutions
CIDOC 2023, Mexico

Hands-on CIDOC CRM 101

- Starter exercise: **This is a**
- Lesson 2: **What's there to talk about?**
- Lesson 3: **What's it called?**
- Lesson 4: **What kind of thing is that?**
- Lesson 5: **What happened?**

CIDOC CRM Ontology and Modelling, Where to Begin?

Language of

90+- Classes / Nouns &
160 +- Properties / Verbs

The Standard: [Link](#)

Friendly Representation: [Link](#)

What is CIDOC CRM?

- “The overall scope of the CIDOC CRM can be summarised in simple terms as the curated knowledge of museums...”
- A lingua franca for cultural heritage specialists to express and exchange knowledge in a machine readable format
- A collaborative effort to support:
 - a generic model of recording of “what has happened” in human scale
 - generate huge, meaningful networks of knowledge by a simple abstraction: history as meetings of people, things and information

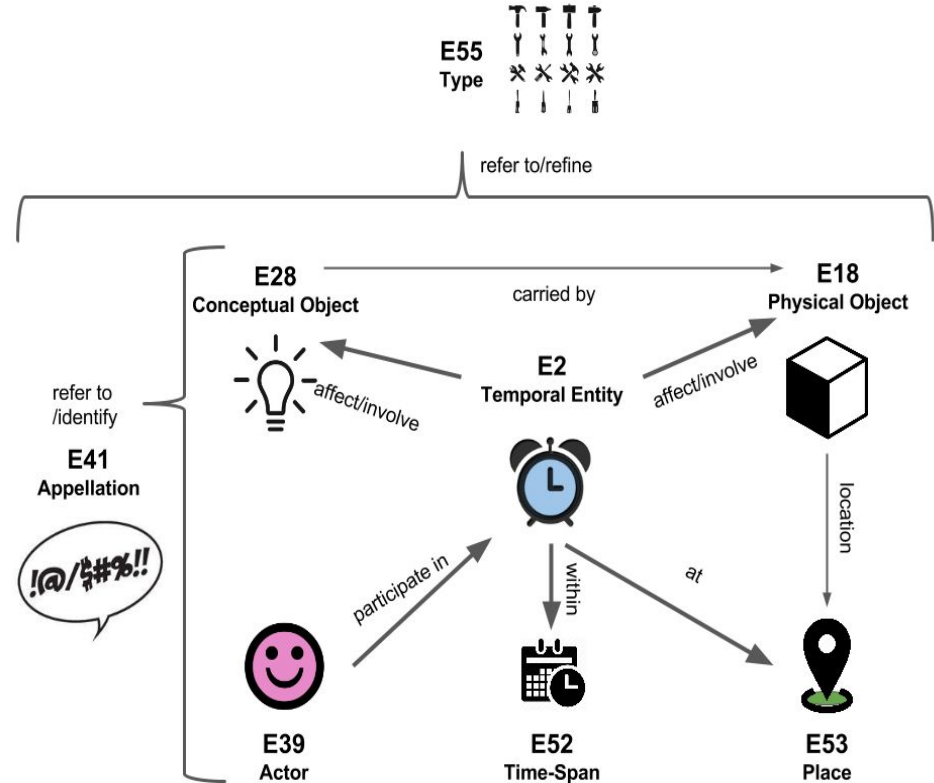

CIDOC CRM Starter exercise:
This is a ...



Lesson 1: This is a ...

The most basic thing that we can and must assert in our formal language to begin communicating about any object is what something is.

X is the thing we are talking about.

“**X** is a **Y**.”

Y is the kind of thing we say it is.

Rdfs:type is the verb that lets us say **X is a Y**.



Lesson 1: Examples

Natural Language

The person **is a** E21 Person

The Eiffel Tower **is a** E22 Human Made Object

The place Paris **is a** E53 Place

The event World War II **is a** E5 Event

The play Hamlet **is a** E28 Conceptual Object

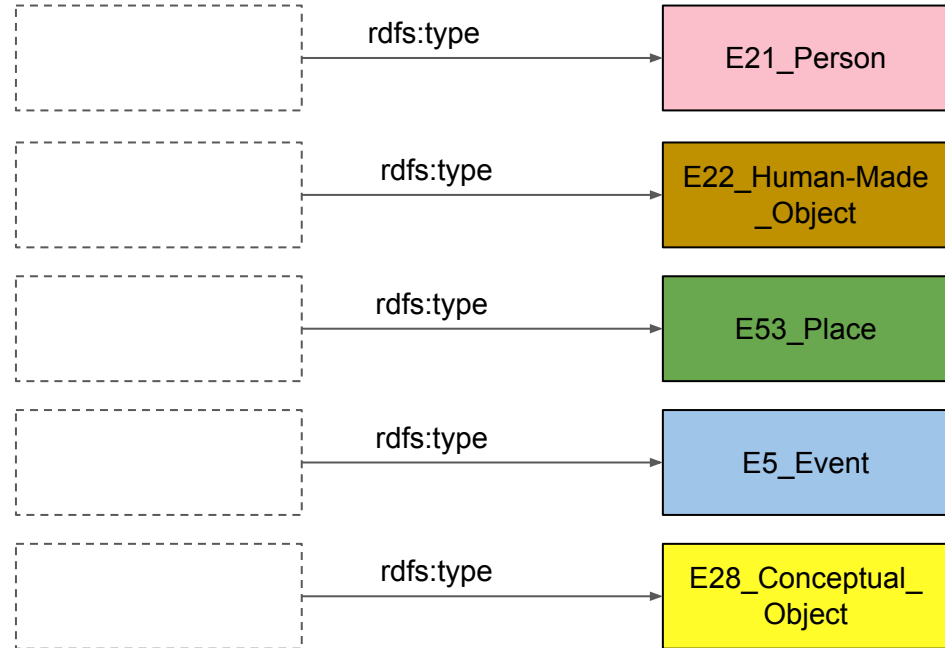
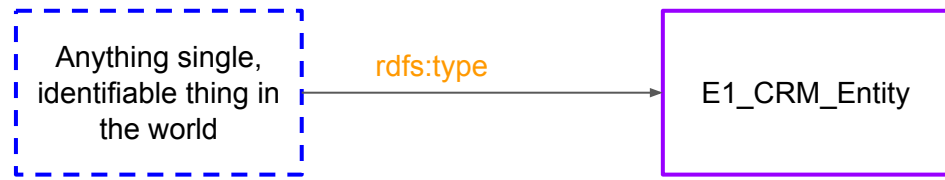

Exercise 1

- Get the instance card that represent your institution
- Get 2 blank cards and fill the information in
- Let's make 2 triples:
- Your name is ...
- I am part of ...

CNRS

Draw a doodle that represents you:

My name is: (fill the blank)

Starter deck

E21 Person

Subclass of: Superclass of:

E41 Appellation

E74 Group

Subclass of: E39 Actor

Scope Note: This class comprises organizations of E... lectively or in a s... form of unifying re... sense... position... certain... of the pr... it may... more... (i.e., a... individ... sona... case o...



P107 has current or former member (is current or former member of)

Domain: E1 CRM Entity

Range: E41 Appellation

Exercise 1a

- Get the instance card that represent your institution
- Get 2 blank cards and fill the information in
- Let's make 2 triples:
 - Your name is ...
 - I am part of ...

E21
Person  

Subclass of: E20 Biological Object - E39 Actor Superclass of:

Scope Note:
This class comprises real persons who live or are assumed to have lived.
Legendary figures that may have existed,

Draw a doodle that represents you:



P1
is identified by
(identifies)

Domain: E1 CRM Entity
Range: E41 Appellation

E41
Appellation

Subclass of: E90 Symbolic Object Superclass of: E35 Title E42 Identifier

Scope Note:

My name is: (fill the blank)

Anaïs Guillem

Exercise 1b

- Get the instance card that represent your institution
- Get 2 blank cards and fill the information in
- Let's make 2 triples:
 - Your name is ...
 - I am part of ...

E74
Group 

Subclass of: E39 Actor Superclass of: E40 Legal Body

Scope Note:
This class comprises any gatherings or organizations of E39 Actors that act collectively or in a similar way due to any wider official decided in dependent cases, where had donym of an a particular

CNRS



P107
has current or former member (is current or former member of)

Domain: E74 Group
Range: E39 Actor

E21
Person 

Subclass of: E20 Biological Object - E39 Actor Superclass of:

Scope Note:
This class comprises real persons who live or are assumed to have lived. Legendary figures that may have existed, all into ers to where persons es can eir re- pose a about

Draw a doodle that represents you:



Lesson 1: Learning Outcomes / Review

Natural Language Sentence Types

This is a ...

Class	Subclass of
-------	-------------

E1 CRM Entity	rdfs:Class
---------------	------------

Basic Formal Language Skill

Indicate an instance of a class

Property	Domain	Range
----------	--------	-------

rdfs:type	rdfs:Resource	rdfs:Class
-----------	---------------	------------

Case study of Notre-Dame de Paris

Semantics works best with examples



Ontology and semantics allow us to create fact based networks of knowledge about real world things. “Stories”, but non-fictional ones.

Here is a textual version of Notre-Dame de Paris:

https://en.wikipedia.org/wiki/Notre-Dame_de_Paris

We will use playing cards to begin to learn how to tell the story of Notre-Dame de Paris using CIDOC CRM:

https://docs.google.com/spreadsheets/d/1Q3sn7kzz_JvmytIKDijYM0CtVzrn4KTumIZxjSSrv8s/edit?usp=sharing

For the rest of this course, the example of Notre-Dame de Paris will provide a frame for exploring how to ‘speak’ with CIDOC CRM.

Lesson 2: What's there to talk about?

Lesson 2: What's there to talk about?

As large and confusing as our world is, the kinds of things that we talk about break down into a very small set of kinds of things. CIDOC CRM allows for describing five basic kinds of things. Learn these and you have the foundation of thinking in this language.

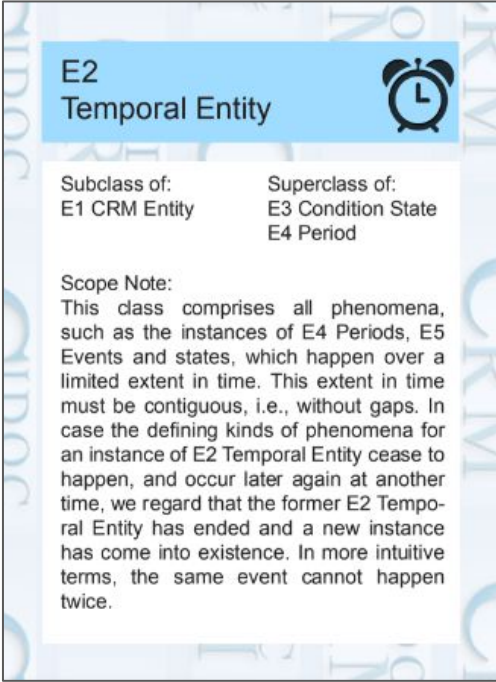

E2
Temporal Entity 

Subclass of:
E1 CRM Entity

Superclass of:
E3 Condition State
E4 Period

Scope Note:
This class comprises all phenomena, such as the instances of E4 Periods, E5 Events and states, which happen over a limited extent in time. This extent in time must be contiguous, i.e., without gaps. In case the defining kinds of phenomena for an instance of E2 Temporal Entity cease to happen, and occur later again at another time, we regard that the former E2 Temporal Entity has ended and a new instance has come into existence. In more intuitive terms, the same event cannot happen twice.

Check these 5
CIDOC CRM
cards

E2_Temporal_Entity

E53_Place

E18_Physical_Thing

E28_Conceptual
_Object

E39_Actor

Lesson 2: Definitions

E2_Temporal_
Entity

Objects which are temporal in nature, something that takes place over time, and about which you want to make assertions regarding their duration, location, involved entities etc.

E53_Place

Objects which are geometric in nature, about which one wants to assert spatial properties like absolute and relative location

E22_Human-Made
_Object

Objects which are material and substantial in nature and exists as unique singular individuals in the world. About these objects one may make direction assertions of dimension, composition, part hole relations, its function as bezrer or holder of information

E28_Conceptual_
Object

Objects which are ideas and exist in form of coherent identifiable concepts that can be identified through time. About these objects one may make direct assertions of composition, part whole relations, their content representational functions.

E21_Person

Objects which are agents in nature, having the capability to act as causes in events. Of which one wishes to make assertions of agency and membership.

1- Notre-Dame de Paris' fire



Exercise 2

Look at the cards for the lesson 2

Separate the Instance cards and CIDOC CRM Entity cards

Match instance cards with the CRM cards

Instance cards deck



CIDOC CRM entity cards

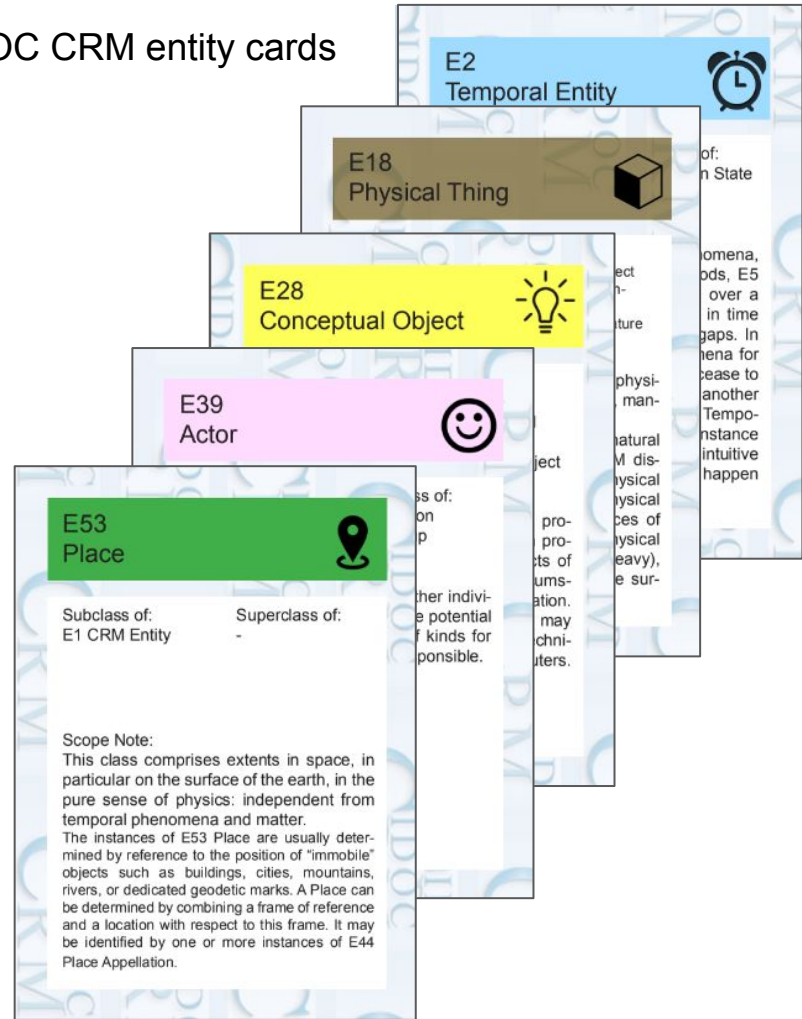
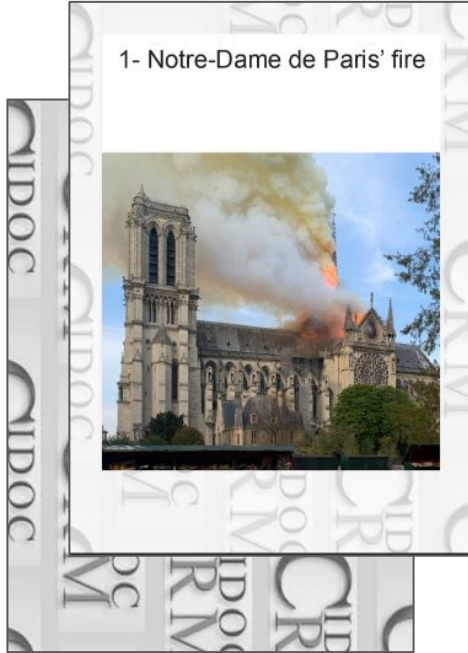



Exercise 2

E2
Temporal Entity 

Subclass of: E1 CRM Entity
Superclass of: E3 Condition State, E4 Period

1- Notre-Dame de Paris' fire





E18
Physical Thing 

Subclass of: E72 Legal Object, E92 Spacetime Volume
Superclass of: E19 Physical Object, E24 Physical Man-Made Thing, E26 Physical Feature

Scope Note:
This class comprises all persistent physical items with a relatively stable form, man-made or natural.
Depending on the existence of natural

5-Notre-Dame de Paris' cathedral (building)



E28
Conceptual Object 

Subclass of: E71 Human-Made Thing
Superclass of: E55 Type, E89 Propositional Object, E90 Symbolic Object

7-Victor Hugo's novel Notre-Dame de Paris





E39
Actor 

Subclass of: E77 Persistent Item
Superclass of: E21 Person, E74 Group

Scope Note:
This class comprises people, either individually or in groups, who have the potential to perform intentional actions of kinds for which someone may be held responsible.

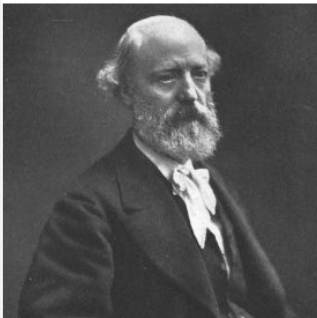
10-Eugène Viollet-le-Duc



E53
Place 

Subclass of: E1 CRM Entity
Superclass of: -

3-Paris, France

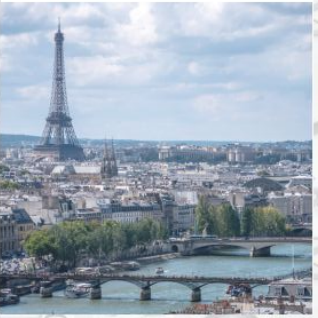

Lesson 2: Learning Outcomes / Review

Natural Language Sentence Types

X is a temporal happening
 X is a geographic place
 X is a physical object
 X is an idea
 X is an agent

Basic Formal Language Skill

Distinguish between the main kinds of entities that you can talk about in CIDOC CRM

Class	Subclass of
E2 Temporal Entity	E1 CRM Entity
E53 Place	E1 CRM Entity
E18 Physical Thing	E70 Thing
E28 Conceptual Object	E71 Human-Made Thing
E39 Actor	E77 Persistent Item

Lesson 3: What's it called?

P1	
is identified by (identifies)	
Domain:	E1 CRM Entity
Range:	E41 Appellation

E41 Appellation	
Subclass of: E90 Symbolic Object	Superclass of: E35 Title E42 Identifier
Scope Note: This class comprises signs, either meaningful or not, or arrangements of signs following a specific syntax, that are used or can be used to refer to and identify a specific instance of some class or category within a certain context.	

13-the City of Light
”The City of Light”

Lesson 3: What's it called?

A basic task in any language is to talk about the names that things have. This is also a basic feature of CIDOC CRM.

Natural language sentences of this type are of the form

X is called Y.

X is the thing we want to give the name of.

Y is the name we want to relate to it.

crm:P1_is_identified_by allows us to make this statement.



Title: Adam naming the Animals
Creator: G. Scotin and J. Cole after H. Gravelot and J.B. Chateelain
Source: <https://bit.ly/3OPYK0S>

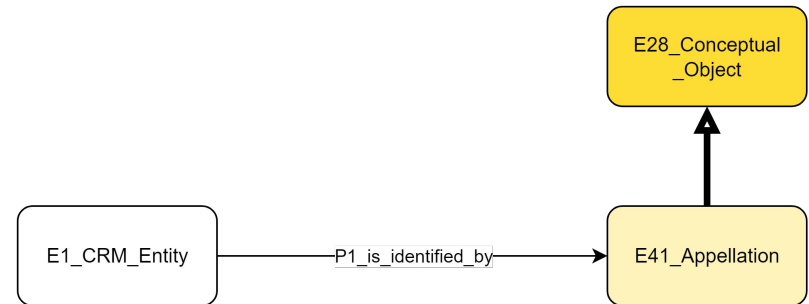

Lesson 3: Examples

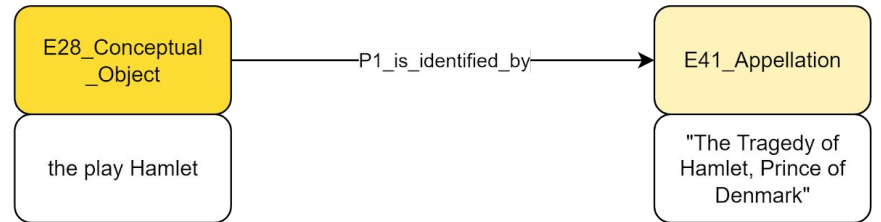
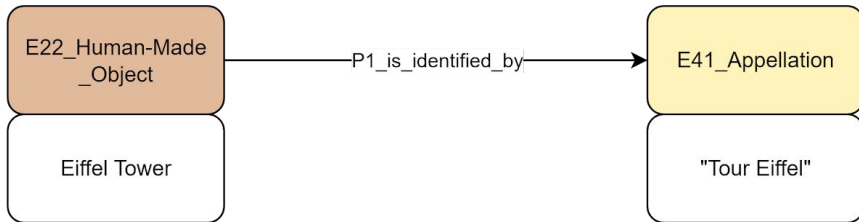
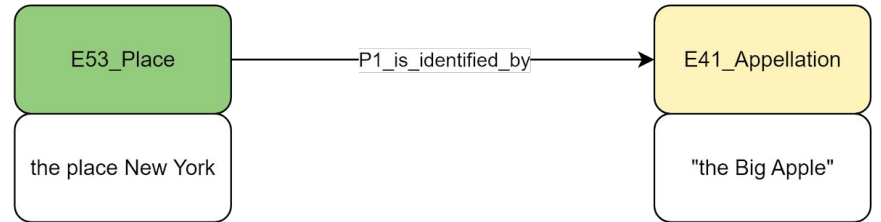
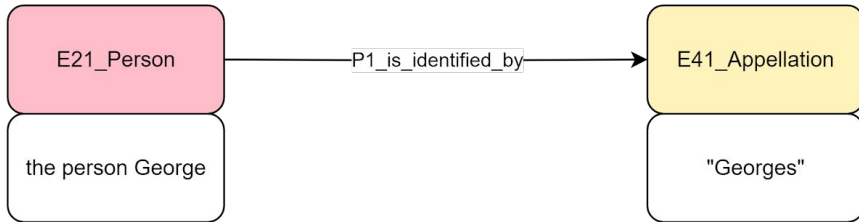
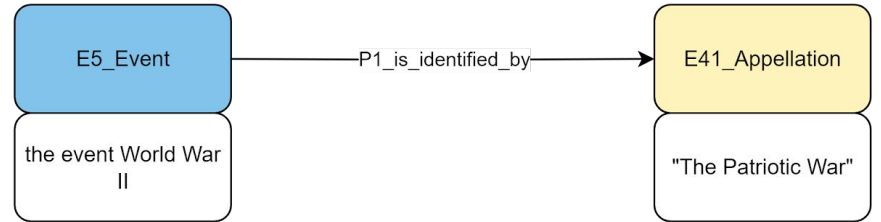
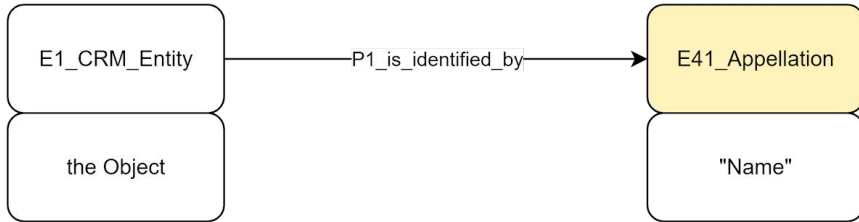

Exercise 3

Try to find at least one appellation that correctly names an instance of:

- E2 Temporal Entity
- E18 Physical Thing
- E53 Place
- E39 Actor
- E28 Conceptual Object

E53
Place

Subclass of: E1 CRM Entity Superclass of: -

Scope Note:
This class comprises extents in space, in particular on the surface of the earth, in the pure sense of physics; independent from temporal extent.

The minimum object is a place, which can be defined as a geographical entity and which can be identified by a name.

3-Paris, France

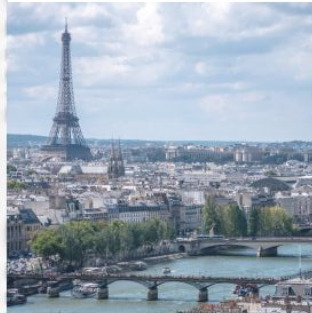

P1
is identified by
(identifies)

Domain: E1 CRM Entity
Range: E41 Appellation

E41
Appellation

Subclass of: E90 Symbolic Object Superclass of: E35 Title, E42 Identifier

13-the City of Light

"The City of Light"

Lesson 3: Learning Outcomes / Review

Natural Language Sentence Types

X is called Y

Basic Formal Language Skill

Connect a documented entity to a name that it has.

Class	Subclass of
E41 Appellation	rdfs:Class

Property	Domain	Range
P1_is_identified_by	E1 CRM Entity	E41 Appellation

Lesson 4: What kind of thing is that?

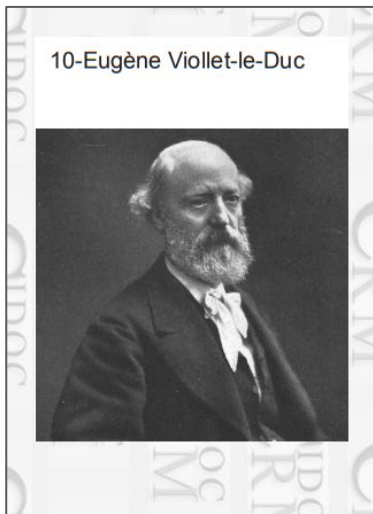

P2
has type
(is type of)

Domain: E1 CRM Entity
Range: E55 Type

E55
Type

T T T T
T I I I
x x x x
I . . I

Subclass of: E28 Conceptual Object
Superclass of: E56 Language E57 Material E58 Measurement Unit

Scope Note:
This class comprises concepts denoted by terms from thesauri and controlled vocabularies used to characterize and classify instances of CRM classes. Instances of E55 Type represent concepts in contrast to instances of E41 Appellation which are used to name instances of CRM classes.
E55 Type is the CRM's interface to domain specific ontologies and thesauri. These can be represented in the CRM as subclasses of E55 Type, forming hierarchies of terms, i.e. instances of E55 Type linked via P127 has broader term (has narrower term). Such hierarchies may be extended with additional properties.

36-architect

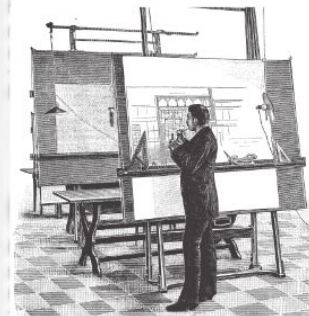

Lesson 4: What kind of thing is that?

A basic task in any language is to classify the things you are talking about, to indicate what kind of thing it is.

Natural language sentences of this type are of the form

X is classified as Y.

X is the thing we want to give the type to.

Y is the type we want to relate to it.

crm:P2_has_type allows us to make this statement.

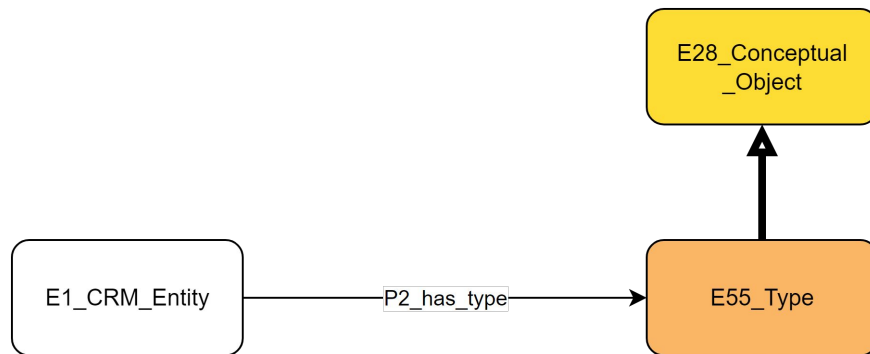

Lesson 4: Examples

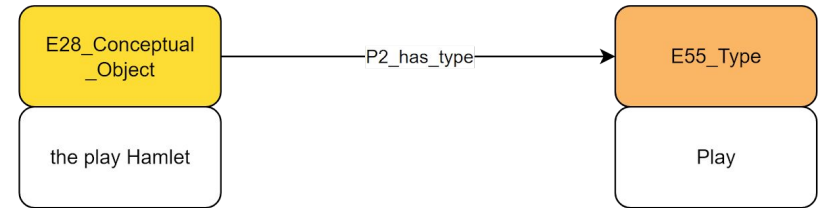
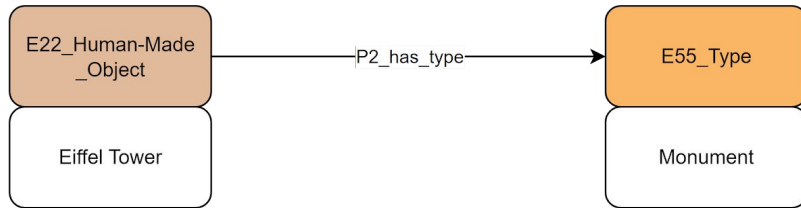
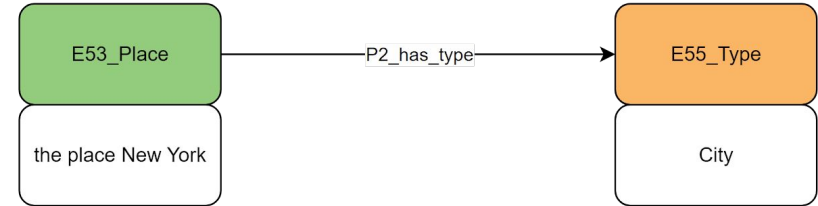
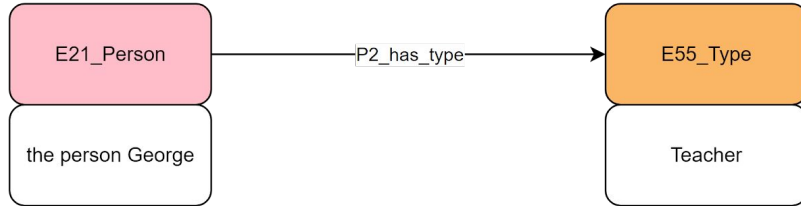
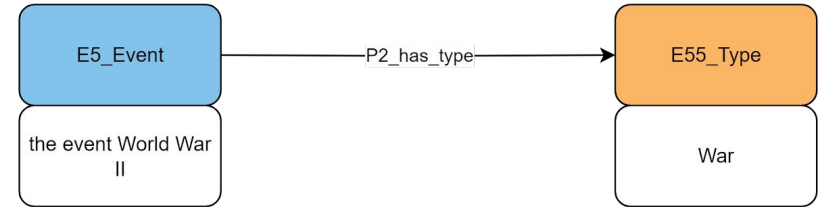
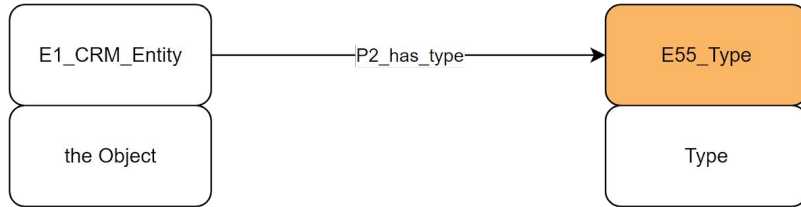

Exercise 4

Try to find at least one type that correctly classifies an instance of:

- E2 Temporal Entity
- E18 Physical Thing
- E53 Place
- E39 Actor
- E28 Conceptual Object

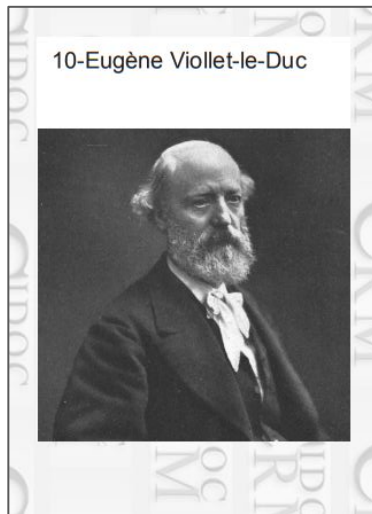

P2
has type
(is type of)

Domain: E1 CRM Entity
Range: E55 Type

E55 Type

Subclass of: E28 Conceptual Object
Superclass of: E56 Language, E57 Material, E58 Measurement Unit

Scope Note:
This class contains terms from various vocabularies and instances of E55 Type used to represent specific objects or types of objects. The form of E55 Type (has narrow extended

36-architect

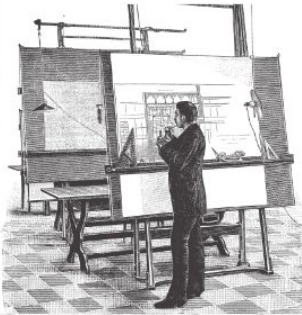
 A black and white illustration of an architect standing at a drafting table in a studio. The architect is wearing a dark suit and is looking at a large architectural drawing on the table. The studio contains various drafting equipment, including a large window with a view of a building, a desk with a lamp, and a checkered floor.

Lesson 4: Learning Outcomes / Review

Natural Language Sentence Types

X is classified as Y
 X is of type Y
 X is of the kind Y

Basic Formal Language Skill

Connect a documented entity to a type that categorizes it

Class	Subclass of
E55 Type	E28 Conceptual Object

Property	Domain	Range
P2_has_type	E1 CRM Entity	E55 Type

Lesson 5: What happened?

Lesson 5: What happened?

Talking about the past, there are typical sets of facts we want to be able to talk about that answer basic questions. When did that happen? Where did it happen? Who was involved? What was involved? All these questions relate to events in the past and this is how CIDOC CRM allows you to express them, as statements about events.

Natural language sentences of this type are of the form

X took place at time Y

X took place at place Q

X involved person P

X involved object Z

Using the event centred representation, CIDOC CRM gives several basic properties which allow you to express these ideas.

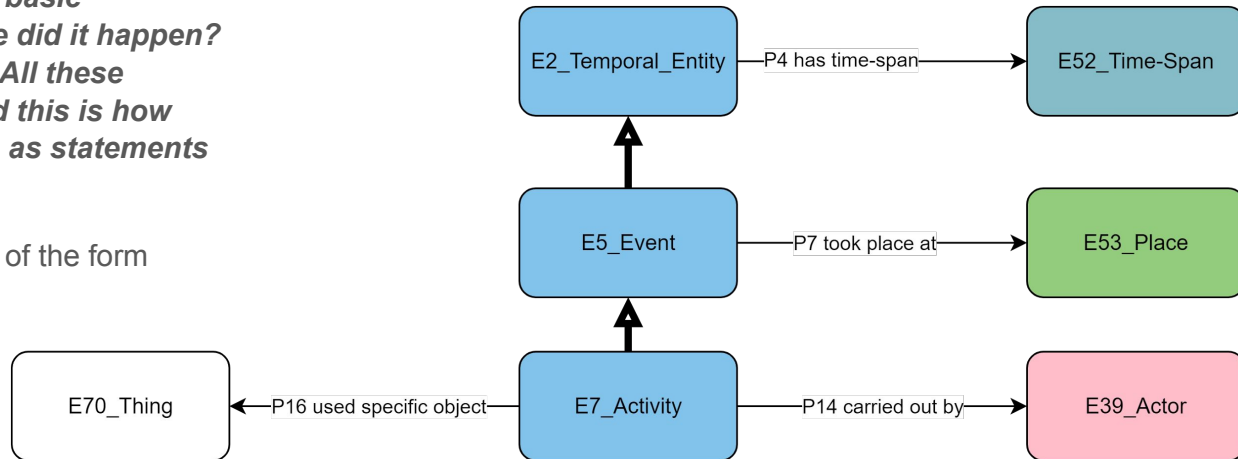

Lesson 5: Examples

Consider the following fictional example and its translation to CIDOC CRM formalization.

- The murder took place on the evening of June 24, 1928, at dusk.
- The murder took place in the parlour.
- The murder was carried out by Mr Plum. (Mr Plum was the murderer)
- The murder used the candlestick. (The candlestick was the murder weapon)

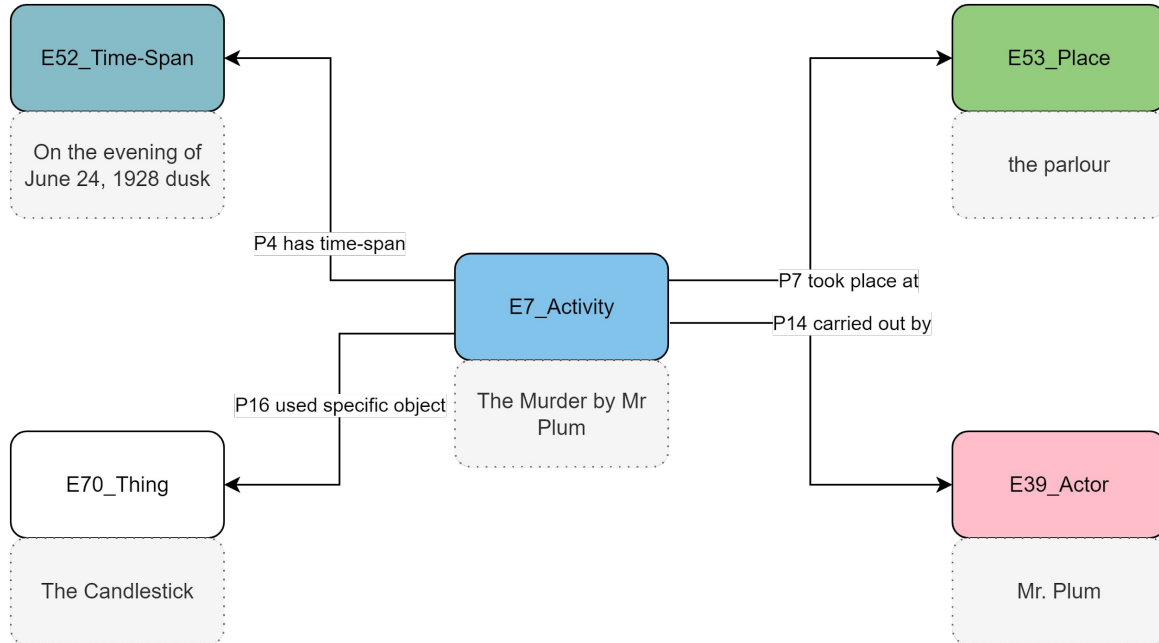

Exercise 5a

Using lesson 5-cards, document the construction of Notre-Dame using CIDOC CRM entities and properties

2-Construction of Notre-Dame

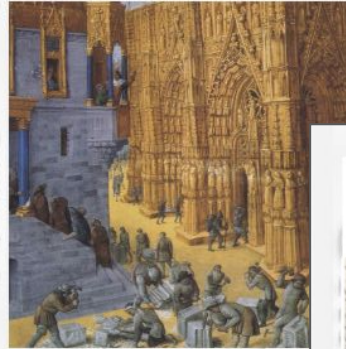

53-time-span of the construction (1163-1260)

1163-1260

9-Bishop Maurice de Sully



Exercise 5b

Using lesson 5-cards, same exercise with the restoration of Notre-Dame by Viollet-le-Duc

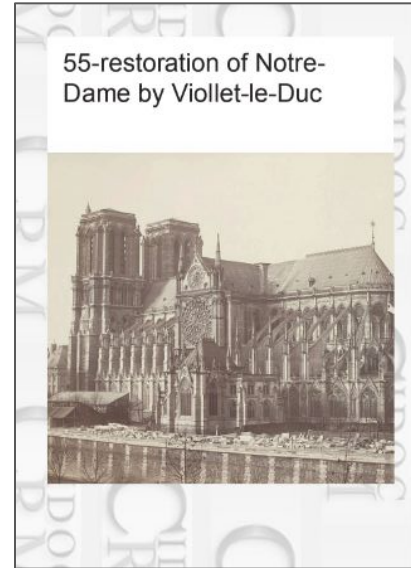

Lesson 5: Learning Outcomes / Review

Natural Language Sentence Types

X took place at time Y
 X took place at place Q
 X involved person P
 X involved object Z

Class	Subclass of
E5 Event	E2 Temporal Entity
E7 Activity	E5 Event

Basic Formal Language Skill

Choose an appropriate property to express your meaning

Choose the correct domain class in order to be able to use your property.

Property	Domain	Range
P4_has_time-span	E2 Temporal Entity	E52 Time-Span
P7_took_place_at	E5 Event	E53 Place
P14 carried out by	E7 Activity	E39 Actor
P16_used_specific_object	E7 Activity	E70 Thing

More to come:

- Lesson 6: Telling Time
- Lesson 7: Describing the Physical
- Lesson 8: Describing the Conceptual
- Lesson 9: Talking about Endings and Beginnings
- Lesson 10: Where is / was it?